



September 2018

REPORT – VOLUME 4A
PHYSICAL ENVIRONMENT



CNOOC UGANDA LIMITED

ENVIRONMENTAL AND
SOCIAL IMPACT
ASSESSMENT FOR THE
CNOOC UGANDA LTD
KINGFISHER OIL
DEVELOPMENT, UGANDA

Submitted to:

The Executive Director National Environment Management Authority
NEMA House, Plot 17/19/21 Jinja Road, P. O. Box 22255 Kampala, Uganda



Report Number: 1776816-318326-2





February 2018

REPORT – VOLUME 4, STUDY 1



CNOOC UGANDA LIMITED

KINGFISHER OIL PROJECT, HOIMA DISTRICT, UGANDA - AIR QUALITY AND GREENHOUSE GAS ASSESSMENT

Submitted to:

The Executive Director National Environment Management Authority, NEMA House,
Plot 17/19/21 Jinja Road, P. O. Box 22255 Kampala, Uganda

Report Number: 1776816-321511-12

Distribution:

- 1 x electronic copy CNOOC Uganda Limited
- 1 x electronic copy NEMA
- 1 x electronic copy Eco & Partner
- 1 x electronic copy Golder





LIST OF ABBREVIATIONS AND TERMS

Chemical Formulae	
As	Arsenic
C ₆ H ₆	Benzene
BTEX	Benzene, Ethylbenzene, Toluene & Xylene
Cd	Cadmium
CaO	Calcium oxide / Lime
CaOH	Calcium hydroxide
CO ₂	Carbon dioxide
CO	Carbon monoxide
CH ₂ Cl ₂	Dichloromethane
CH ₃ -S-S-CH ₃	Dimethyl disulphide
CH ₃ -S-CH ₃	Dimethyl sulphide
C ₈ H ₁₀	Ethylbenzene
Pb	Lead
CH ₄	Methane
C ₄ H ₈ O	Methyl ethyl ketone
CH ₃ S-H	Methyl mercaptan
Ni	Nickle
NO ₂	Nitrogen dioxide
NO	Nitrogen oxide
NO _x	Nitrogen oxides
PM ₁₀	Particulates with an aerodynamic diameter of less than 10 µm
PM _{2.5}	Particulates with an aerodynamic diameter of less than 2.5 µm
PAH	Polycyclic aromatic compounds
Na ₂ CO ₃	Sodium bicarbonate
NaOH	Sodium hydroxide / Caustic soda / Soda ash
SO ₂	Sulphur dioxide
H ₂ SO ₄	Sulphuric acid
H ₂ SO ₃	Sulphurous acid
C ₇ H ₈	Toluene
TRS	Total Reduced Sulphur
TSP	Total Suspended Particulates
VOC	Volatile Organic Compounds
C ₈ H ₁₀	Xylene

Countries	
EU	European Union
RSA	South Africa
UK	United kingdom



AIR QUALITY AND GREENHOUSE GAS ASSESSMENT

US	United States
Direction	
N	North
NNE	North-North-East
NE	North-East
ENE	East-North-East
E	East
ESE	East-South-East
SE	South-East
SSE	South-South-East
S	South
SSW	South-South-West
SW	South-West
WSW	West-South-West
W	West
WNW	West-North-West
NW	North West
NNW	North-North-West
Environmental management	
AQIA	Air Quality Impact Assessment
AQMP	Air Quality Management Plan
AQMPr	Air Quality Management Programme
CS	Concept Study
DMP	Dust Management Plan
EIA	Environmental Impact Assessment
EMP	Environmental Management Plan
LoM	Life of Mine
PFS	Pre-Feasibility Study
S&SD	Safety and Sustainable Development
S&EIA	Social and Environmental Impact Assessment
WRD	Waste Rock Dump
Equipment	
PiD	Photo Ionisation Detector
Health	
COHb	Carboxyhaemoglobin
LOAEL	Lowest Observed Adverse Effect Level
NOAEL	No Observed Adverse Effect Level



AIR QUALITY AND GREENHOUSE GAS ASSESSMENT

MSDS	Material safety data sheets
------	-----------------------------

Measurement	
amsl	Above mean sea level
asl	Above sea level
BDL	Below detection limit
°	Degrees
°C	Degrees Celsius
g/s	Grams per second
K	Kelvin
km	Kilometre
km/h	Kilometre per hour
m	Metres
m/s	Metres per second
µg	Microgram
µg/m ³	Micrograms per cubic meter
mg	Milligrams
mg/m ³	Milligrams per cubic meter
mg/m ² /day	Milligrams per meter squared per day
ppb	Parts per billion
tpa	Tons per annum
t/day	Tons per day
t/hr	Tons per hour

Organisations	
EA-NPI	Environment Australia - National Pollutant Inventory
EC	European Commission
IFC	International Finance Corporation
SANAS	South African National Accreditation System
UE-EA	United Kingdom - Environmental Agency
UK-EA	European Union - Environmental Agency
US-EPA	United States - Environmental Protection Agency
WHO	World Health Organisation





Table of Contents

1.0 INTRODUCTION	1
1.1 Project Description.....	1
1.2 Project Location	1
2.0 TERMS OF REFERENCE.....	4
2.1 Objectives of the Air Quality Impact Assessment	4
2.2 Scope of Work	4
2.2.1 Baseline Assessment.....	4
2.2.2 Impact Assessment.....	4
2.3 Regulatory Context	5
2.3.1 Institutional framework	7
2.3.1.1 National Environment Management Authority	7
2.3.1.2 Petroleum Exploration and Production Department	7
2.3.1.3 District Government.....	7
2.4 Assessment Criteria.....	7
2.4.1 Local Standards	7
2.4.1.1 Emission Limits.....	7
2.4.1.2 Air Quality Standards.....	8
2.4.2 International Guidelines	8
2.4.2.1 Emission Guidelines	8
2.4.2.2 Air Quality Guidelines	15
2.5 Assessment Rating.....	19
3.0 BASELINE ASSESSMENT	21
3.1 Topography.....	21
3.2 Land Cover and Use.....	22
3.3 Sensitive Receptors.....	24
3.4 Atmospheric Dispersion Potential.....	25
3.4.1 Boundary Layer Properties and Atmospheric Stability.....	26
3.5 Regional climate	27
3.6 Meso Scale Meteorology	27
3.6.1 Wind Direction and Speed	27
3.6.2 Temperature and Humidity	27





3.6.3	Rainfall	28
3.7	Local meteorology.....	28
3.7.1	Wind Direction and Speed	29
3.7.2	Temperature.....	31
3.7.3	Rainfall	32
3.8	Modelled meteorology	34
3.8.1	Wind Roses	34
3.8.2	Meteorological Cross Check.....	37
3.9	Ambient Air Quality Overview.....	38
3.9.1	Agricultural Activities	38
3.9.2	Mining Activities	38
3.9.3	Oil Extraction and Refining	38
3.9.4	Domestic Fuel Burning.....	39
3.9.5	Biomass Burning	39
3.9.6	Vehicle emissions	40
3.9.7	Wheel generated Dust on Unpaved Roads.....	40
3.9.8	Wheel Generated Dust on Paved Roads	40
3.9.9	Summary of the Regional Air Quality	40
3.10	Health Effects of Exposures to Various Pollutants.....	40
3.10.1	Nitrogen Dioxide (NO ₂)	40
3.10.2	Sulphur Dioxide (SO ₂).....	40
3.10.3	Particulates (TSP, PM ₁₀ , PM _{2.5} and dust fallout).....	41
3.10.4	Hydrogen Sulphide (H ₂ S).....	41
3.10.5	Volatile Organic Compounds (VOC's).....	41
3.10.6	Summary	41
4.0	IMPACT ASSESSMENT	43
4.1	Development Description and Proposed Infrastructures	43
4.1.1	Well pads for drilling and production	45
4.1.1.1	Well pad locations.....	45
4.1.1.2	Well pads for drilling	45
4.1.1.3	Well drilling	45
4.1.1.4	Well pads for oil production	46
4.1.2	Flowlines	47





4.1.3	Central Processing Facility	48
4.1.3.1	CPF Location	49
4.1.3.2	CPF Capacity.....	49
4.1.3.3	Typical CPF Layout and main components	49
4.1.3.4	Electricity Generation and Distribution System.....	52
4.1.3.5	Water Abstraction and Injection	52
4.1.3.6	Instrumentation and Control System.....	53
4.1.4	Export Pipeline	54
4.1.5	Supporting Infrastructures.....	56
4.1.5.1	Access roads	56
4.1.5.2	Airstrip.....	56
4.1.5.3	Camps and materials yard	56
4.1.5.3.1	Camps	56
4.1.5.3.2	Materials yards.....	58
4.1.5.4	Jetty	59
4.1.6	Proposed construction activities	60
4.1.7	Overview of the implementation phases of the project	60
4.1.8	Kingfisher Operations Overview	62
4.1.8.1	Overview of the process flow at the CPF.....	62
4.1.8.2	Liquid-liquid separation and oil stabilisation.....	62
4.1.8.3	Flash gas compression.....	64
4.1.8.4	Oil storage and export	65
4.2	Air Emission Inventory	67
4.2.1	Construction	69
4.2.2	Operation.....	69
4.2.2.1	Abnormal Operations.....	71
4.2.3	Decommissioning.....	71
4.3	Simulations Inputs.....	72
4.3.1	Modelling Domain	72
4.3.2	Topography.....	72
4.3.3	Meteorology.....	72
4.4	Modelling Results.....	73
4.5	Air Quality Impact Assessment.....	90





4.5.1	Project impact rating	90
4.5.2	Construction	94
4.5.3	Operation.....	94
4.5.4	Decommissioning.....	94
4.6	Conclusions and Recommendations	94
5.0	REFERENCES	97

TABLES

Table 1: Regulatory context.....	5
Table 2: IFC Emission Guidelines for Small Combustion Facilities (3MW – 50MW)	9
Table 3: IFC Emission Guidelines for Reciprocating Engines (>50MW)	10
Table 4: IFC emission guidelines for combustion turbines (>50MW)	13
Table 5: IFC ambient air quality guidelines	15
Table 6: International air quality guidelines standards	17
Table 7: Impact assessment criteria and rating scale – Air Quality	19
Table 8: Determination of impact severity	20
Table 9: Atmospheric stability classes.	26
Table 10: Acute and chronic health effects associated with exposure to the primary pollutants of concern	42
Table 11: Existing and proposed well pads co-ordinates.....	45
Table 12: Composition of the natural gas.....	68
Table 13: Physical parameters for emission sources.	68
Table 14: Locations of emission sources.	69
Table 15: Emissions from drilling (6000kW power pack).....	69
Table 16: Emissions from drilling (6000kW power pack).....	70
Table 17: Emissions from power generation.....	70
Table 18: Emissions from flaring.	70
Table 19: Fugitive emissions from oil handling and storage.....	71
Table 20: Receptor grids.	72
Table 21: Impact assessment criteria and rating scale – Air Quality	90
Table 22: Air quality impact assessment rating for construction.....	91
Table 23: Air quality impact assessment rating for operations	92
Table 24: Air quality impact assessment rating for decommissioning	93
Table 25: Air quality management plan.....	95

FIGURES

Figure 1: Location of the Kingfisher field in Uganda	2
--	---





Figure 2: Location of block 3A (EA3A) in relation to the Kingfisher filed and export pipeline.	3
Figure 3: EA3A topography.	21
Figure 4: EA3A land cover and use.	22
Figure 5: Kingfisher land cover and use.	23
Figure 6: Sensitive receptors.	24
Figure 7: Buhuka Flats – Wind Direction 2010 (iWeather 2014).	29
Figure 8: Buhuka Flats – Wind Direction 2011 (iWeather 2014).	29
Figure 9: Buhuka Flats – Wind Direction 2013 (iWeather 2014).	30
Figure 10: Buhuka Flats – Wind Speed 2010 (iWeather 2014).	30
Figure 11: Buhuka Flats – Wind Speed 2011(iWeather 2014).	30
Figure 12: Buhuka Flats – Temperature 2010 (iWeather 2014).	31
Figure 13: Buhuka Flats – Temperature 2011 (iWeather 2014).	31
Figure 14: Buhuka Flats – Temperature 2012 (iWeather 2014).	31
Figure 15: Buhuka Flats – Temperature 2013 (iWeather 2014).	32
Figure 16: Buhuka Flats – Rainfall 2010 (iWeather 2014).	32
Figure 17: Buhuka Flats – Rainfall 2011 (iWeather 2014).	32
Figure 18: Buhuka Flats – Rainfall 2012 (iWeather 2014).	33
Figure 19: Buhuka Flats – Rainfall 2013 (iWeather 2014).	33
Figure 20: Period Wind Rose – Buhuka Flats 2011 - 2016.	34
Figure 21: Diurnal Wind Roses – Buhuka Flats 2011 - 2016.	35
Figure 22: Seasonal Wind Roses – Buhuka Flats 2011 - 2016.	36
Figure 23: Meteorological cross check.	37
Figure 24: Project main infrastructure.	43
Figure 25: Production profiles for the Kingfisher oil field.	44
Figure 26: Example of a well pad at drilling stage.	45
Figure 27: An illustration of directional drilling.	46
Figure 28: A well head (left) and production manifold (right) (for illustration).	47
Figure 29: Flowlines schematics.	48
Figure 30: Layout of the Central Processing Facility (CPF) in relation to other facilities.	50
Figure 32: Layout for a typical workers’ camp.	58
Figure 33: Layout for a typical materials yard.	59
Figure 34: Project implementation.	61
Figure 35: Typical process flow diagram of the CPF (only for illustration purpose).	63
Figure 36: Typical crude oil process (only for illustration purpose).	64
Figure 37: Flow chart of flash gas compression (only for illustration purpose).	65
Figure 38: Flow chart of crude oil storage and export (only for illustration purpose).	66





Figure 39: Construction - drilling on well pad 1, NO₂ maximum hourly concentration (99th percentile)..... 74

Figure 40: Construction - drilling on well pad 2, NO₂ maximum hourly concentration (99th percentile)..... 75

Figure 41: Construction - drilling on well pad 3, NO₂ maximum hourly concentration (99th percentile)..... 76

Figure 42: Construction - drilling on well pad 4, NO₂ maximum hourly concentration (99th percentile)..... 77

Figure 43: Construction - drilling on well pad 1, NO₂ maximum annual concentration. 78

Figure 44: Construction - drilling on well pad 2, NO₂ maximum annual concentration. 79

Figure 45: Construction - drilling on well pad 3, NO₂ maximum annual concentration. 80

Figure 46: Construction - drilling on well pad 4, NO₂ maximum annual concentration. 81

Figure 47: Operations - drilling on well pad 1, NO₂ maximum hourly concentration (99th percentile). 82

Figure 48: Operations - drilling on well pad 2, NO₂ maximum hourly concentration (99th percentile). 83

Figure 49: Operations - drilling on well pad 3, NO₂ maximum hourly concentration (99th percentile). 84

Figure 50: Operations - drilling on well pad 4, NO₂ maximum hourly concentration (99th percentile). 85

Figure 51: Operations - drilling on well pad 1, NO₂ maximum annual concentration..... 86

Figure 52: Operations - drilling on well pad 2, NO₂ maximum annual concentration..... 87

Figure 53: Operations - drilling on well pad 3, NO₂ maximum annual concentration..... 88

Figure 54: Operations - drilling on well pad 4, NO₂ maximum annual concentration..... 89

APPENDICES

No table of contents entries found.





1.0 INTRODUCTION

The China National Offshore Oil Corporation (CNOOC) requested Golder Associates Africa (Pty) Ltd. (GAA) to undertake an Environmental and Social Impact Assessment (ESIA) for the development of the Kingfisher oilfield.

This report presents the specialist air quality baseline assessment for the oilfield which will inform the ESIA, conducted in terms of the International Finance Corporation (IFC) standards and Ugandan legislative requirements, specifically:

- Environmental Assessment Regulations; and
- Environmental Quality Guidelines for Ambient Air.

1.1 Project Description

Tullow Uganda Operations Pty Ltd (Tullow), Total E&P Uganda Ltd (Total) and CNOOC Uganda Limited (CNOOC) are planning to develop oilfields within the Albertine graben in western Uganda. The three companies have formed a partnership with equal interests in three government-designated exploration areas (EAs) or "Blocks", with Tullow assuming operatorship of EA2, Total of EA1 and CNOOC of Kingfisher field, formerly in EA3A. The EAs and oilfields (Figure 1) lie along the eastern border of Lake Albert, a 160 km-long, up to 30 km-wide water body which is shared by Uganda and the Democratic Republic of the Congo (DRC). On the 16th of September 2013, the first oil production license in Uganda was awarded to CNOOC. The license gives CNOOC the right to develop the Kingfisher field in EA3 to full production (Figure 1).

1.2 Project Location

The Kingfisher oilfield is located within the administrative boundary of the Buhuka Sub-County in the Hoima District; it is approximately 15.2 km long by 3.0 km wide and covers an oil area of 32.3km². Although much of the field lies under Lake Albert, the structural culmination in the Kingfisher lies under a narrow strip of land, some 10km by 2km, formed against the basin bounding fault known as the Buhuka Flats. The location of EA3A and the project area are indicated in Figure 2.



AIR QUALITY AND GREENHOUSE GAS ASSESSMENT

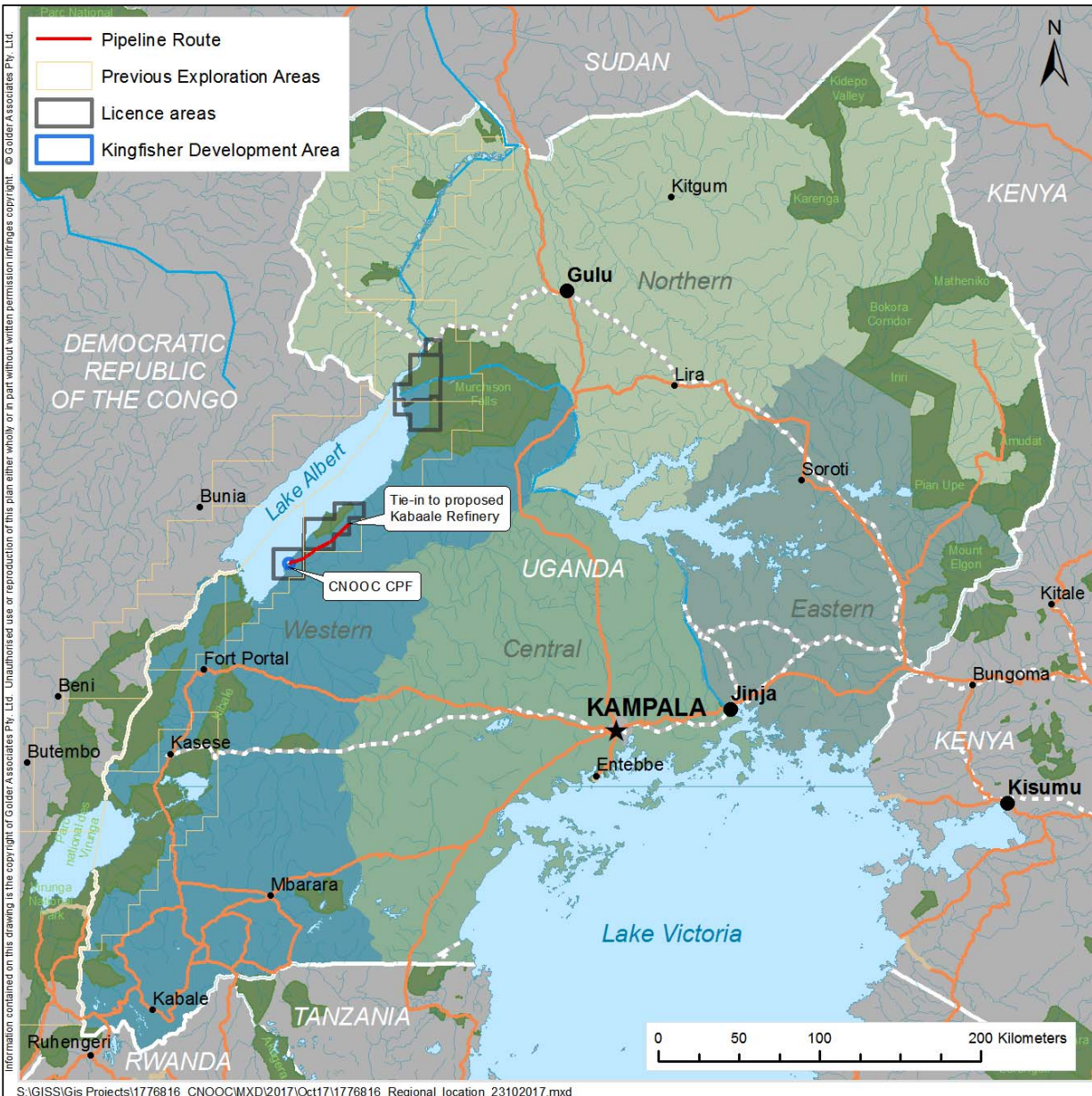

Figure 1: Location of the Kingfisher field in Uganda.





AIR QUALITY AND GREENHOUSE GAS ASSESSMENT

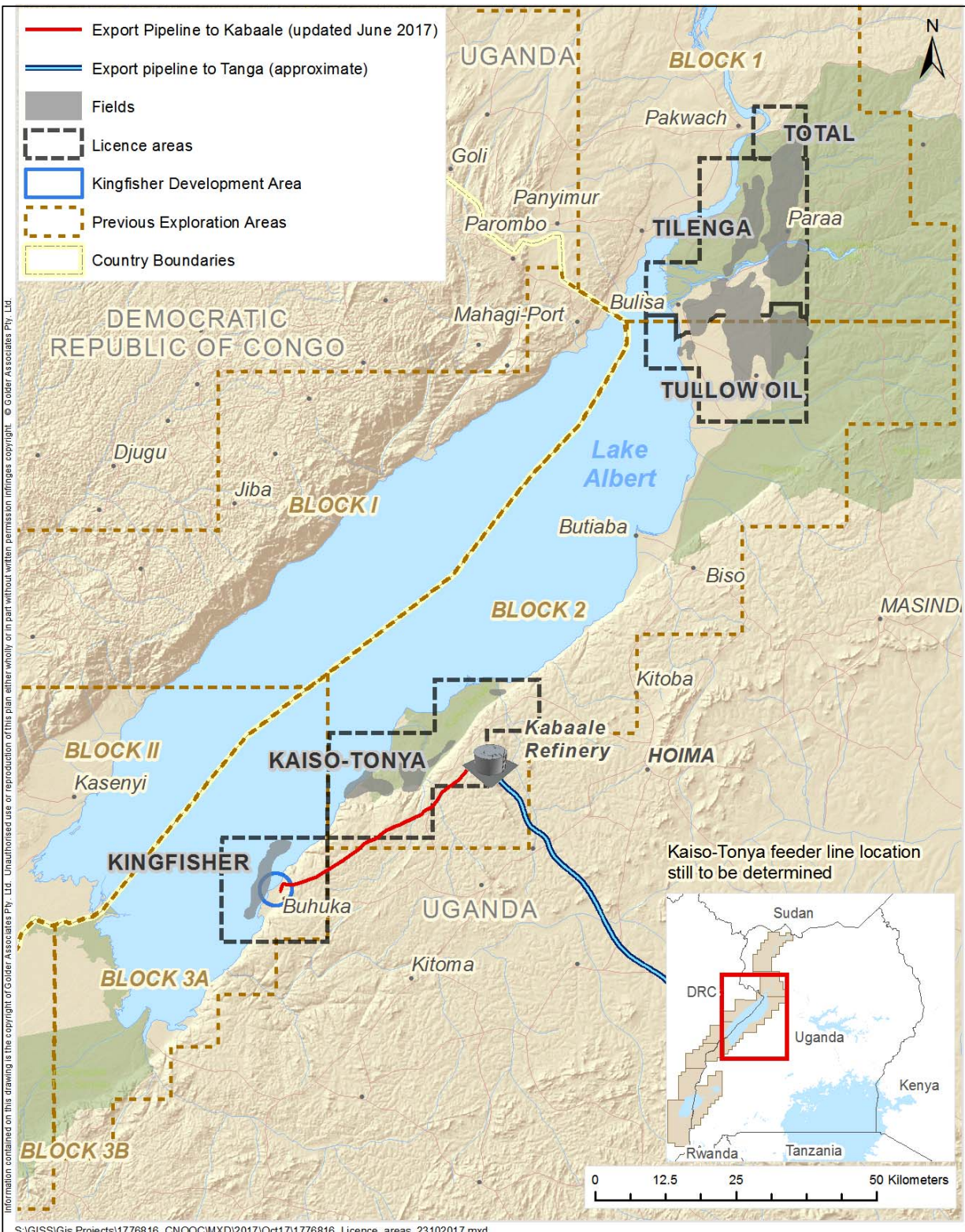

Figure 2: Location of block 3A (EA3A) in relation to the Kingfisher field and export pipeline.





2.0 TERMS OF REFERENCE

2.1 Objectives of the Air Quality Impact Assessment

The objectives of the air quality impact assessment are to:

- To describe the baseline meteorology and ambient air quality of the study area;
- To develop an inventory of potential sources of air emissions associated with the proposed project, and assess these emissions in relation to:
 - Local emission standards (Ugandan); and
 - International emission guidelines (IFC);
- To perform dispersion modelling to simulate the spatial and temporal impacts of emissions of key pollutants from the proposed project, and assess these predictions in relation to the risk to human health and nuisance factor (odour etc.) by comparison to:
 - Local air quality standards (Ugandan); and
 - International air quality guidelines (IFC);
- Assess and recommend various technological alternatives to minimise air quality impacts associated with the proposed project.

2.2 Scope of Work

The scope of work is for an air quality impact assessment report comprising of a:

- Baseline assessment; and
- Impact Assessment.

2.2.1 Baseline Assessment

The baseline air quality assessment will include:

- The sourcing and collating of available baseline air quality and meteorological information;
- Literature review of the potential health effects associated with emissions from the proposed development;
- Identification of sensitive receptors, such as local communities, within the surrounding areas;
- Review of applicable air quality legislation, policies and standards (local and IFC);
- Analysis of site-specific or MM5 modelled meteorological data;
- A gaps analysis to determine what additional air quality information is required; and
- The development of a baseline air quality monitoring network.

2.2.2 Impact Assessment

The air quality impact assessment for the proposed projects will involve the following activities:

- Identification and quantification of potential sources of air emissions from the proposed development, where measurements aren't available United States Environmental Protection Agency (EPA) and /or Australian National Pollutant Inventory (NPI) emission estimation techniques will be used. Air emissions sources surrounding the proposed development (if information is available) will also be taken into consideration considered to determine cumulative effects.



- Dispersion modelling for the normal operations, emergency events, start up and shut down, pollutant parameters to be considered include:
 - Nitrogen Dioxide (NO₂);
 - Sulphur Dioxide (SO₂),
 - Hydrogen Sulphide (H₂S);
 - Particulates (PM₁₀) and (PM_{2.5}); and selected
 - Volatile Organic Compounds (Benzene, Toluene, Ethyl Benzene and Xylene).
- Analysis of dispersion modelling results and associated air quality impact;
- Comparison of the modelling results to the observed baseline data (If suitable baseline data is available);
- Provide recommendations for mitigating / managing the impact of air emissions; and
- An air quality management planning section for inclusion into the facilities EMP.

2.3 Regulatory Context

Prior to assessing the impacts, reference needs to be made to the environmental regulations and guidelines governing the emissions and impacts thereof. This section presents the policy, legal, and administrative framework within which the AQIA and EBS will be carried out. It summarizes policies, laws, regulations, standards and guidelines relevant to the environmental management of the proposed project. It also identifies agencies, departments and institutions responsible for the monitoring and enforcement of legal requirements specified therein.

Table 1: Regulatory context.

Instrument/Legislation	Summary	Relevance to the project
National Policies		
The National Environment Management Policy, 1994		
The National Oil and Gas Policy, 2008		
The National Energy Policy, 2002		
National Laws		
The Constitution of the Republic of Uganda, 1995	The Constitution, as the supreme law, provides the legal and regulatory framework in the country and provides for all aspects pertaining to the environment and other related aspects.	
The National Environment Act, Cap. 153	The National Environment Act is the principal environmental law of Uganda and establishes the Authority (NEMA) as the principal agency in Uganda for the management of the environment. Under Section 19, the Act states the criteria under which EIA shall be required for a proposed development.	In accordance with the Act, the proposed project qualifies for EIA as per Section 19(1) (a) and the Third Schedule.
The Petroleum (Exploration and Production) Act, Cap 150	The Petroleum (Exploration and Production) Act, Cap 150 regulates the 'upstream' (i.e. exploration and production) sector of the industry.	Under Section 31, the Act outlines the obligations and duties of the licensee that include the duty to implement good oil field practices





AIR QUALITY AND GREENHOUSE GAS ASSESSMENT

Instrument/Legislation	Summary	Relevance to the project
		and prevent pollution of the development area through the escape of petroleum, drilling fluid, water or any other substance associated with exploration and development activities
The Petroleum (Exploration, Development and Production) Act, 2013	The Petroleum (Exploration, Development and Production) Act operationalises the National Oil and Gas Policy of Uganda. Among its other functions, the Act seeks to establish institutions to manage petroleum resources and regulate petroleum activities including licensing, exploration, development, production and decommissioning.	Section 3 outlines the environmental principles to which all licensees shall comply including the duty to comply with the principles of the National Environment Act, the duty to: Manage waste arising out of petroleum activities in accordance with the National Environment Act and all applicable legislation; and Contract a separate entity to manage the transportation, treatment and disposal of waste arising out of petroleum activities.
The Local Governments Act, Cap 243	The Local Governments Act, Cap 243 establishes a form of government based on the District as the main unit of administration. The Districts are given legislative and planning powers under this Act. They also plan for the conservation of environment within their local area.	District Environment Committees established under Section 15 of the National Environment Act are supposed to guide the district authorities in matters relating to conservation of the environment. District authorities must therefore be involved at an early stage of project implementation since they have a stake as overseers of environmental issues in their areas of jurisdiction.
The Public Health Act, Cap 281	The main objective of the Public Health Act is to safeguard and promote public health.	Section 54 provides a general prohibition of nuisances or conditions liable to be hazardous to health on any land.
National Regulations		
The Environmental Impact Assessment Regulations, 1998	The EIA Regulations, 1998 specify the general requirements for good EIA practice in Uganda.	The proponent is required to undertake the ESIA in accordance with the regulations including, preparation and submission of Terms of Reference, provision of all contents for an environmental impact statement outlined under Regulation 14. Public participation: Sub-regulation (1) of Regulation 12 requires the





Instrument/Legislation	Summary	Relevance to the project
		developer to take all measures necessary to seek the views of the people in the communities which may be affected by the project. Regulations 19, 20, 21, 22 and 23 outline further requirements for public participation.
The Petroleum Exploration and Production (Conduct of Exploration Operations) Regulations, 1993	These outline the minimum standards governing the exploration and production activities in Uganda.	In accordance with Section 51 (1), the proponent is required to implement all necessary measures to prevent pollution of the environment during development and production operations and the transportation of petroleum.

2.3.1 Institutional framework

The following are the key institutional stakeholders who have an interest in the project.

2.3.1.1 National Environment Management Authority

The National Environment Management Authority (NEMA) is the principal agency in Uganda for the management of the environment, mandated to coordinate, monitor and supervise all activities in the field of the environment. In accordance with its functions stipulated under section 6, subsection (1) of the National Environment Act Cap 153; the authority is mandated to ensure observance of proper safeguards in the planning and execution of all development projects, including those already in existence that have or are likely to have significant impact on the environment.

2.3.1.2 Petroleum Exploration and Production Department

The Petroleum Exploration and Production Department (PEPD) operate as one of the technical departments under the Ministry of Energy and Mineral Development (MEMD) and are mandated to establish the petroleum potential of the country, and is therefore the key lead agency for the project. In accordance with Section 22 (1) of the National Environment Act, the authority (NEMA) shall in consultation with lead agency be responsible for carrying out audits of all activities that are likely to have significant effects on the environment.

2.3.1.3 District Government

District Local Government is defined as one of the lead agencies under the National Environment Act and is mandated to establish a District Environment Committee that coordinates with NEMA on all issues relating to environment management. The District Environment Officer (DEO) in particular will play an active role in monitoring of environmental aspects, and liaise with the NEMA on all matters relating to the environment. The Act also provides for the establishment of Local Environment Committees that may be appointed to monitor all activities within their local jurisdiction to ensure that such activities do not have any significant impact on the environment, and to report any events or activities which have or are likely to have significant impacts on the environment to the District Environment Officer.

2.4 Assessment Criteria

2.4.1 Local Standards

2.4.1.1 Emission Limits

There are currently no Ugandan point source emission limits; in the absence of these, emissions will be assessed according to IFC guidelines.





2.4.1.2 *Air Quality Standards*

Ugandan air quality standards are currently in the draft stage, air impacts will therefore be assessed according to IFC ambient air quality guidelines.

2.4.2 *International Guidelines*

This section contains the most updated versions of the World Bank Group Environmental, Health, and Safety Guidelines (known as the "EHS Guidelines"). The EHS Guidelines were developed as part of a two and a half year review process that ended in 2007. They are intended to be living documents and are occasionally updated.

The EHS Guidelines are technical reference documents with general and industry-specific examples of Good International Industry Practice (GIIP), as defined in IFC's Performance Standard 3: Resource Efficiency and Pollution Prevention. IFC uses the EHS Guidelines as a technical source of information during project appraisal activities, as described in IFC's Environmental and Social Review Procedures Manual.

The EHS Guidelines contain the performance levels and measures that are normally acceptable to IFC and that are generally considered to be achievable in new facilities at reasonable costs by existing technology. For IFC-financed projects, application of the EHS Guidelines to existing facilities may involve the establishment of site-specific targets with an appropriate timetable for achieving them. The environmental assessment process may recommend alternative (higher or lower) levels or measures, which, if acceptable to IFC, become project or site-specific requirements.

When host country regulations differ from the levels and measures presented in the EHS Guidelines, projects will be required to achieve whichever is more stringent. If less stringent levels or measures than those provided in the EHS Guidelines are appropriate in view of specific project circumstances, a full and detailed justification must be provided for any proposed alternatives through the environmental and social risks and impacts identification and assessment process. This justification must demonstrate that the choice for any alternate performance levels is consistent with the objectives of Performance Standard 3.

2.4.2.1 *Emission Guidelines*

Guideline values for process emissions in this sector are indicative of good international industry practice as reflected in relevant standards of countries with recognized regulatory frameworks. These guidelines are assumed to be achievable under normal operating conditions in appropriately designed and operated facilities through the application of pollution prevention and control techniques. These levels should be achieved, without dilution, at least 95 percent of the time that the plant or unit is operating, to be calculated as a proportion of annual operating hours. Deviation from these levels in consideration of specific, local project conditions should be justified in the environmental assessment

Emission guidelines applicable to gas engines and turbines the project are provided in Table 2, Table 3 and Table 4.



AIR QUALITY AND GREENHOUSE GAS ASSESSMENT

Table 2: IFC Emission Guidelines for Small Combustion Facilities (3MW – 50MW)

Small Combustion Facilities Emissions Guidelines (3MWth – 50MWth HHV heat input) – (in mg/Nm ³ or as indicated)				
Combustion Technology / Fuel	Particulate Matter (PM)	Sulphur Dioxide (SO ₂)	Nitrogen Oxides (NO _x)	Dry Gas, Excess O ₂ Content (%)
Engine				
Gas	N/A	N/A	200 (Spark Ignition) 400 (Dual Fuel) 1,600 (Compression Ignition)	15%
Liquid	50 or up to 100 if justified by project specific considerations (e.g. Economic feasibility of using lower ash content fuel, or adding secondary treatment to meet 50, and available environmental capacity of the site)	1.5 percent Sulphur or up to 3.0 percent Sulphur if justified by project specific considerations (e.g. Economic feasibility of using lower S content fuel, or adding secondary treatment to meet levels of using 1.5 percent Sulphur, and available environmental capacity of the site)	If bore size diameter [mm] < 400: 1460 (or up to 1,600 if justified to maintain high energy efficiency.) If bore size diameter [mm] > or = 400: 1,850	15%
Turbine				
Natural Gas =3MWth to < 15MWth	N/A	N/A	42ppm (Electric generation) 100ppm (Mechanical drive)	15%
Natural Gas =15MWth to < 50MWth	N/A	N/A	25ppm	15%
Fuels other than Natural Gas =3MWth to < 15MWth	N/A	0.5 percent Sulphur or lower percent Sulphur (e.g. 0.2 percent Sulphur) if commercially available without significant excess fuel cost	96ppm (Electric generation) 150ppm (Mechanical drive)	15%
Fuels other than Natural Gas =15MWth to < 50MWth	N/A	0.5% S or lower % S (0.2%S) if commercially available without significant excess fuel cost	74ppm	15%
Boiler				
Gas	N/A	N/A	320	3%
Liquid	50 or up to 150 if justified by environmental assessment	2000	460	3%
Solid	50 or up to 150 if justified by environmental assessment	2000	650	6%



AIR QUALITY AND GREENHOUSE GAS ASSESSMENT

Small Combustion Facilities Emissions Guidelines (3MWth – 50MWth HHV heat input) – (in mg/Nm³ or as indicated)

Notes: N/A/ - no emissions guideline; Higher performance levels than these in the Table should be applicable to facilities located in urban / industrial areas with degraded airsheds or close to ecologically sensitive areas where more stringent emissions controls may be needed.; MWth is heat input on HHV basis; Solid fuels include biomass; Nm3 is at one atmosphere pressure, 0°C.; MWth category is to apply to the entire facility consisting of multiple units that are reasonably considered to be emitted from a common stack except for NOx and PM limits for turbines and boilers. Guidelines values apply to facilities operating more than 500 hours per year with an annual capacity utilization factor of more than 30 percent.

Table 3: IFC Emission Guidelines for Reciprocating Engines (>50MW)

IFC Emissions Guidelines (in mg/Nm ³ or as indicated) for Reciprocating Engines (>50MW HHV heat input)							
Note: Guidelines are applicable for new facilities. EA may justify more stringent or less stringent limits due to ambient environment, technical and economic considerations provided there is compliance with applicable ambient air quality standards and incremental impacts are minimized. For projects to rehabilitate existing facilities, case-by-case emission requirements should be established by the EA considering (i) the existing emission levels and impacts on the environment and community health, and (ii) cost and technical feasibility of bringing the existing emission levels to meet these new facilities limits. EA should demonstrate that emissions do not contribute a significant portion to the attainment of relevant ambient air quality guidelines or standards, and more stringent limits may be required.							
Combustion Technology / Fuel	Particulate Matter (PM)		Sulphur Dioxide (SO ₂)		Nitrogen Oxides (NO _x)		Dry Gas, Excess O ₂ Content (%)
	NDA	DA	NDA	DA	NDA	DA	
Reciprocating Engine	NDA	DA	NDA	DA	NDA	DA	
Natural Gas	N/A	N/A	N/A	N/A	200 (Spark Ignition) 400 (Dual Fuel) (a)	200 (SI) 400 (Dual Fuel / CI)	15%
Liquid Fuels (Plant >50MWth to <300MWth)	50	30	1,170 or use of 2% or less S fuel	0.5% S	1,460 (Compression Ignition, bore size diameter [mm] < 400) 1,850 (Compression Ignition, bore size diameter [mm] ≥ 400) 2,000 (Dual Fuel)	400	15%





AIR QUALITY AND GREENHOUSE GAS ASSESSMENT

IFC Emissions Guidelines (in mg/Nm ³ or as indicated) for Reciprocating Engines (>50MW HHV heat input)							
Liquid Fuels (Plant >=300MWth)	50	30	585 or use of 1% or less S fuel	0.2% S	740 (contingent upon water availability for injection)	400	15%
Biofuels / Gaseous Fuels other than Natural Gas	50	30	N/A	N/A	30% higher limits than those provided above for Natural Gas and Liquid Fuels.	200 (SI, Natural Gas), 400 (other)	15%

General notes:

MWth = Megawatt thermal input on HHV basis; N/A = not applicable; NDA = Non-degraded airshed; DA = Degraded airshed (poor air quality); Airshed should be considered as being degraded if nationally legislated air quality standards are exceeded or, in their absence, if WHO Air Quality Guidelines are exceeded significantly; S = sulphur content (expressed as a percent by mass); Nm³ is at one atmospheric pressure, 0 degree Celsius; MWth category is to apply to the entire facility consisting of multiple units that are reasonably considered to be emitted from a common stack. Guideline limits apply to facilities operating more than 500 hours per year. Emission levels should be evaluated on a one hour average basis and be achieved 95% of annual operating hours.

(a) Compression Ignition (CI) engines may require different emissions values which should be evaluated on a case-by-case basis through the EA process.

Comparison of the Guideline limits with standards of selected countries / region (as of August 2008):

Natural Gas-fired Reciprocating Engine – NOx

Guideline limits: 200 (SI), 400 (DF)

UK: 100 (CI), US: Reduce by 90% or more, or alternatively 1.6 g/kWh

Liquid Fuels-fired Reciprocating Engine – NOx (Plant >5 MWth to <300MWth)

Guideline limits: 1,460 (CI, bore size diameter < 400mm), 1,850 (CI, bore size diameter ≥ 400 mm), 2,000 (DF)

UK: 300 (> 25 MWth), India: 1,460 (Urban area & ≤ 75MWe (≈ 190MWth), Rural area & ≤ 150MWe (≈ 380MWth))

Liquid Fuels-fired Reciprocating Engine – NOx (Plant ≥300MWth)

Guideline limits: 740 (contingent upon water availability for injection)

UK: 300 (> 25MWth), India: 740 (Urban area & > 75MWe (≈ 190MWth), Rural area & > 150MWe (≈ 380MWth))

Liquid Fuels-fired Reciprocating Engine – SO₂

Guideline limits: 1,170 or use of ≤ 2% S (Plant >50MWth to <300MWth), 585 or use of ≤ 1% S (Plant ≥300MWth)

EU: Use of low S fuel oil or the secondary FGD (IPCC LCP BREF), HFO S content ≤ 1% (Liquid Fuel Quality Directive), US: Use of diesel fuel with max S of 500 ppm (0.05%); EU: Marine HFO S content ≤ 1.5% (Liquid Fuel Quality Directive) used in SO_x Emission Control Areas; India: Urban (< 2% S), Rural (< 4%S), Only diesel fuels (HSD, LDO) should be used in Urban



AIR QUALITY AND GREENHOUSE GAS ASSESSMENT

IFC Emissions Guidelines (in mg/Nm³ or as indicated) for Reciprocating Engines (>50MW HHV heat input)

Source: UK (S2 1.03 Combustion Processes: Compression Ignition Engines, 50 MWth and over), India (SOx/NOx Emission Standards for Diesel Engines ≥ 0.8 MW), EU (IPCC LCP BREF July 2006), EU (Liquid Fuel Quality Directive 1999/32/EC amended by 2005/33/EC), US (NSPS for Stationary Compression Ignition Internal Combustion Engine – Final Rule – July 11, 2006)



AIR QUALITY AND GREENHOUSE GAS ASSESSMENT

Table 4: IFC emission guidelines for combustion turbines (>50MW)

IFC Emissions Guidelines (in mg/Nm ³ or as indicated) for Combustion Turbines (>50MW HHV heat input)						
<p>Note: Guidelines are applicable for new facilities. EA may justify more stringent or less stringent limits due to ambient environment, technical and economic considerations provided there is compliance with applicable ambient air quality standards and incremental impacts are minimized. For projects to rehabilitate existing facilities, case-by-case emission requirements should be established by the EA considering (i) the existing emission levels and impacts on the environment and community health, and (ii) cost and technical feasibility of bringing the existing emission levels to meet these new facilities limits. EA should demonstrate that emissions do not contribute a significant portion to the attainment of relevant ambient air quality guidelines or standards, and more stringent limits may be required.</p>						
Combustion Technology / Fuel	Particulate Matter (PM)		Sulphur Dioxide (SO ₂)		Nitrogen Oxides (NO _x)	Dry Gas, Excess O ₂ Content (%)
Reciprocating Engine	NDA	DA	NDA	DA	NDA / DA	
Natural Gas (all turbine types of Unit > 50MWth)	N/A	N/A	N/A	N/A	51 (25 ppm)	15%
Fuels other than Natural Gas (Unit >> 50MWth)	50	30	Use of 1% or less S fuel	Use of 0.5% or less S fuel	152 (74 ppm) ^a	15%
<p>General notes: MWth = Megawatt thermal input on HHV basis; N/A = not applicable; NDA = Non-degraded airshed; DA = Degraded airshed (poor air quality); Airshed should be considered as being degraded if nationally legislated air quality standards are exceeded or, in their absence, if WHO Air Quality Guidelines are exceeded significantly; S = sulphur content (expressed as a percent by mass); Nm³ is at one atmospheric pressure, 0 degree Celsius; MWth category is to apply to single units; Guideline limits apply to facilities operating more than 500 hours per year. Emission levels should be evaluated on a one hour average basis and be achieved 95% of annual operating hours. If supplemental firing is used in a combined cycle gas turbine mode, the relevant guideline limits for combustion turbines should be achieved including emissions from those supplemental firing units (e.g., duct burners). (a) Technological differences (for example the use of Aero derivatives) may require different emissions values which should be evaluated on a cases-by-case basis through the EA process but which should not exceed 200 mg/Nm³. Comparison of the Guideline limits with standards of selected countries / region (as of August 2008):</p>						





AIR QUALITY AND GREENHOUSE GAS ASSESSMENT

IFC Emissions Guidelines (in mg/Nm³ or as indicated) for Combustion Turbines (>50MW HHV heat input)

Natural Gas-fired Combustion Turbine – NO_x

Guideline limits: 51 (25ppm)

EU: 50 (24ppm), 75 (37ppm) (if combined cycle efficiency > 55%), $50 \cdot \eta / 35$ (where η = simple cycle efficiency)

US: 25 ppm (> 50MMBtu/h (\approx 14.6 MWth) and \leq 850MMBtu/h (\approx 249MWth)), 15 ppm (> 850 MMBtu/h (\approx 249MWth))

(Note: further reduced NO_x ppm in the range of 2 to 9 ppm is typically required through air permit)

Liquid Fuel-fired Combustion Turbine – NO_x

o Guideline limits: 152 (74 ppm) – Heavy Duty Frame Turbines & LFO/HFO, 300 (146 ppm) – Aero derivatives & HFO, 200 (97 ppm) – Aero derivatives & LFO

o EU: 120 (58 ppm), US: 74 ppm (> 50 MMBtu/h (\approx 14.6 MWth) and \leq 850 MMBtu/h (\approx 249MWth)), 42 ppm (> 850 MMBtu/h (\approx 249 MWth))

Liquid Fuel-fired Combustion Turbine – SO_x

o Guideline limits: Use of 1% or less S fuel

o EU: S content of light fuel oil used in gas turbines below 0.1% / US: S content of about 0.05% (continental area) and 0.4% (non-continental area)

Source: EU (LCP Directive 2001/80/EC October 23 2001), EU (Liquid Fuel Quality Directive 1999/32/EC, 2005/33/EC), US (NSPS for Stationary Combustion Turbines, Final Rule – July 6, 2006)





2.4.2.2 Air Quality Guidelines

Air quality guidelines are fundamental to effective air quality management, providing the link between the source of atmospheric emissions and the user of that air at the downstream receptor site. Ambient air quality guideline values indicate safe daily exposure levels for the majority of the population, including the very young and the elderly, throughout an individual’s lifetime. Air quality guidelines are normally given for specific averaging or exposure periods.

Projects with significant sources¹ of air emissions, and potential for significant impacts to ambient air quality, should prevent or minimize impacts by ensuring that:

- Emissions do not result in pollutant concentrations that reach or exceed relevant ambient quality guidelines and standards by applying national legislated standards, or in their absence, the current WHO Air Quality Guidelines, or other internationally recognized sources; and
- Emissions do not contribute a significant portion to the attainment of relevant ambient air quality guidelines or standards. As a general rule, the IFC General EHS Guideline suggests 25% of the applicable air quality standards to allow additional, future sustainable development in the same airshed.

IFC ambient air quality guidelines applicable to the project are provided in Table 5, comparative international standards are provide in Table 6.

Table 5: IFC ambient air quality guidelines

IFC Ambient Air Quality Guidelines		
	Averaging Period	Guideline Value in µg/m ³
Particulate Matter PM ₁₀	1-year	70 (Interim target-1)
		50 (Interim target-2)
		30 (Interim target-3)
		20 (guideline)
24-hour		150 (Interim target-1)
		100 (Interim target-2)
		75 (Interim target-3)
		50 (guideline)
Particulate Matter PM _{2.5}	1-year	35 (Interim target-1)
		25 (Interim target-2)
		15 (Interim target-3)
		10 (guideline)
24-hour		75 (Interim target-1)
		50 (Interim target-2)
		37.5 (Interim target-3)
		25 (guideline)
Sulphur dioxide (SO ₂)	24-hour	125 (Interim target-1)
		50 (Interim target-2)
		20 (guideline)
	10 minute	500 (guideline)
Nitrogen dioxide (NO ₂)	1-year	40 (guideline)
	1-hour	200 (guideline)

¹ Significant sources of point and fugitive emissions are considered to be general sources which, for example, can contribute a net emissions increase of one or more of the following pollutants within a given airshed: PM₁₀: 50 tons per year; NO_x: 500tpy; SO₂: 500tpy; or as established through national legislation; and combustion sources with an equivalent heat input of 50MWth or greater. The significance of emissions of inorganic and organic pollutants should be established on a project-specific basis taking into account toxic and other properties of the pollutant.





AIR QUALITY AND GREENHOUSE GAS ASSESSMENT

IFC Ambient Air Quality Guidelines			
Ozone	8-hour daily maximum	160 (Interim target-1) 100 (guideline)	
Notes: World Health Organization (WHO). Air Quality Guidelines Global Update, 2005. PM 24-hour value is the 99th percentile. Interim targets are provided in recognition of the need for a staged approach to achieving the recommended guidelines. Ambient air quality standards are ambient air quality levels established and published through national legislative and regulatory processes, and ambient quality guidelines refer to ambient quality levels primarily developed through clinical, toxicological, and epidemiological evidence (such as those published by the World Health Organization) (WHO, 2005).			





AIR QUALITY AND GREENHOUSE GAS ASSESSMENT

Table 6: International air quality guidelines standards

Organisation	Compound	Date Effective	Averaging Time	Concentration ($\mu\text{g}/\text{m}^3$)	Comment
European Union	Benzene (C_6H_6)	2015	1 year	5	Not to be exceeded
	Nitrogen Dioxide (NO_2)	2010	1 hour	200	18 exceedances permitted per year
	Nitrogen Dioxide (NO_2)	2010	1 year	40	Not to be exceeded
	Particulate Matter (PM_{10})	2005	1 year	40	Not to be exceeded
	Particulate Matter (PM_{10})	2005	24 hours	50	Not to be exceeded
	Particulate Matter ($\text{PM}_{2.5}$)	2015	1 year	25	Not to be exceeded
	Sulphur Dioxide (SO_2)	2005	1 hour	350	24 exceedances permitted per year
	Sulphur Dioxide (SO_2)	2005	24 hours	125	3 exceedances permitted per year
UK Environment Agency	Benzene (C_6H_6)	2015	1 year	5	Not to be exceeded
	Nitrogen Dioxide (NO_2)	2010	1 hour	200	18 exceedances permitted per year
	Nitrogen Dioxide (NO_2)	2010	1 year	40	Not to be exceeded
	Particulate Matter (PM_{10})	2005	1 year	40	Not to be exceeded
	Particulate Matter (PM_{10})	2005	24 hours	50	35 exceedances permitted per year
	Particulate Matter ($\text{PM}_{2.5}$)	2010	1 year	25	Not to be exceeded
	Particulate Matter ($\text{PM}_{2.5}$)	2020	1 year	20	Not to be exceeded
	Sulphur Dioxide (SO_2)	2005	1 hour	350	35 exceedances permitted per year
	Sulphur Dioxide (SO_2)	2001	1 year	20	Not to be exceeded
	Sulphur Dioxide (SO_2)	2005	24 hours	125	3 exceedances permitted per year
UK Environment Agency (AEL)	Ethylbenzene (C_8H_{10})	2000	1 year	4410	Not to be exceeded
	Toluene (C_7H_8)	2000	1 year	1910	Not to be exceeded
	Xylene (C_8H_{10})	2000	1 year	4410	Not to be exceeded
US EPA	Nitrogen Dioxide (NO_2)	2010	1 hour	188	98th percentile, averaged over 3 years



AIR QUALITY AND GREENHOUSE GAS ASSESSMENT

Organisation	Compound	Date Effective	Averaging Time	Concentration ($\mu\text{g}/\text{m}^3$)	Comment
	Nitrogen Dioxide (NO_2)	2010	1 year	100	Annual Mean
	Particulate Matter (PM_{10})	2012	24 hours	150	Not to be exceeded more than once per year on average over 3 years.
	Particulate Matter ($\text{PM}_{2.5}$)	2012	1 year	12	Annual mean, averaged over 3 years
	Particulate Matter ($\text{PM}_{2.5}$)	2012	24 hours	35	98th percentile, averaged over 3 years
	Sulphur Dioxide (SO_2)	2010	1 hour	141	99th percentile of 1-hour daily maximum concentrations, averaged over 3 years



2.5 Assessment Rating

The methodology and approach to be followed during impact assessment in the detailed ESIS is described below.

Potential impacts during the construction, operational and decommissioning/restoration phases of the project will be considered separately in the ESIA.

The impact assessment process compares the intensity of the impact with the sensitivity of the receiving environment. This method relies on a detailed description of both the impact and the environmental or social component that is the receptor. The intensity of an impact depends on its characteristics, which may include such factors as its duration, reversibility, area of extent, and nature in terms of whether positive, negative, direct, indirect or cumulative.

Once the magnitude of the impact and the sensitivity of the receiving environment have been described, the severity of the potential impact can be determined. The determination of significance of an impact is largely subjective and primarily based on professional judgment (Table 7).

Table 7: Impact assessment criteria and rating scale – Air Quality

Criterion	Rating	Definition
Magnitude (the expected magnitude or size of the impact)	Negligible	Pollutant concentration ≤ 25% of guidelines. ²
	Very Low	Pollutant concentration >25% and ≤ 50% of guidelines.
	Moderate	Pollutant concentration >50% and ≤ 100% of guidelines.
	Major	Pollutant concentration >100% of guidelines.
Sensitivity of Receptor (VEC)	Negligible	Infrastructure (no human exposure).
	Very Low	Infrastructure (worker occupational exposure).
	Moderate	Camps (worker medium-term exposure)
	Major	Villages (public long-term / repeated exposure)

To provide a relative illustration of impact significance, it is useful to assign numerical descriptors to the impact magnitude and receptor sensitivity for each potential impact. Each is assigned a numerical descriptor of 1, 2, 3, or 4, equivalent to very low, low, medium or high).

The significance of impact is then indicated by the product of the two numerical descriptors, with significance being described as negligible, minor, moderate or major, as in Table 8.

² As a general rule, the IFC General EHS Guideline suggests 25% percent of the applicable air quality standards to allow additional, future sustainable development in the same airshed.





Table 8: Determination of impact severity

			Sensitivity of receptor			
			Very low	Low	Medium	High
			1	2	3	4
Magnitude of Impact	Very low	1	1 Negligible	2 Minor	3 Minor	4 Minor
	Low	2	2 Minor	4 Minor	6 Moderate	8 Moderate
	Medium	3	3 Minor	6 Moderate	9 Moderate	12 Major
	High	4	4 Minor	8 Moderate	12 Major	16 Major

Note that this is not a standard Golder methodology it is being used because it has been approved by:

- The Ugandan authorities; and
- CNOOC's partners.





3.0 BASELINE ASSESSMENT

In characterising the baseline air quality, reference is made to details concerning the Kingfisher oilfield’s atmospheric dispersion potential and other potential sources of atmospheric emissions in the area. The consideration of the existing air quality is important so as to facilitate the assessment of the potential for cumulative air pollutant concentrations arising due to proposed developments.

3.1 Topography

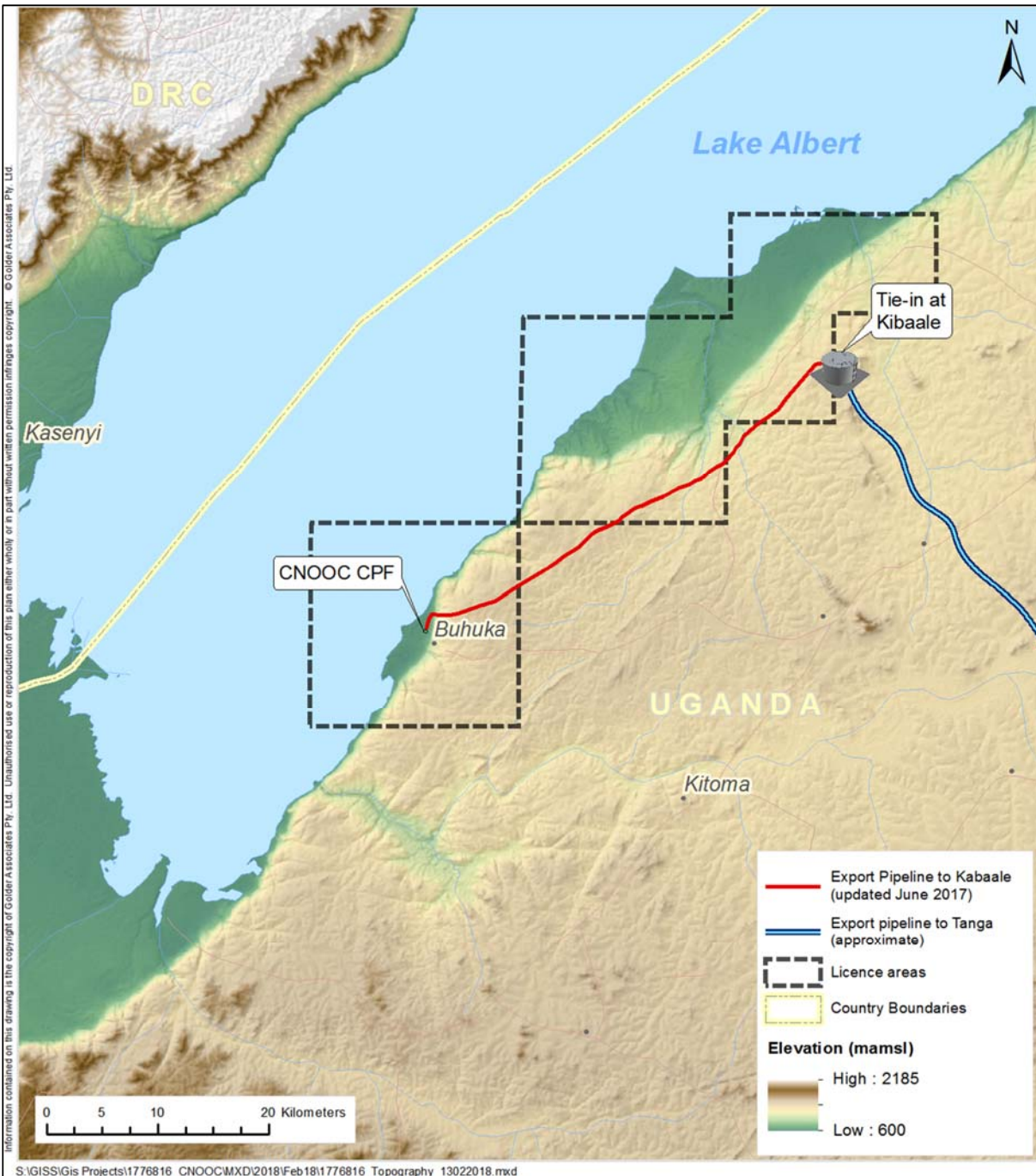

Figure 3: EA3A topography.





AIR QUALITY AND GREENHOUSE GAS ASSESSMENT

The largest proportion of the Rift Valley area therefore is, of low agricultural potential. This partly explains the current major use of the Albertine graben as a conservation area. However, the rift escarpment region receives moderate to high rainfall, largely due to orographic factors, which increases with altitude. As a result of both moderate to high rainfall and moderately productive soils in these areas, rich agricultural activities take place based on both food and cash crops. Agriculture in the area is both large scale and small scale. The dominant food crops include beans, maize and bananas although these crops are also often sold for cash income. Tea plantations are found in Bugaambe sub-county in Hoima (Figure 4 and Figure 5) (NEMA 2010).

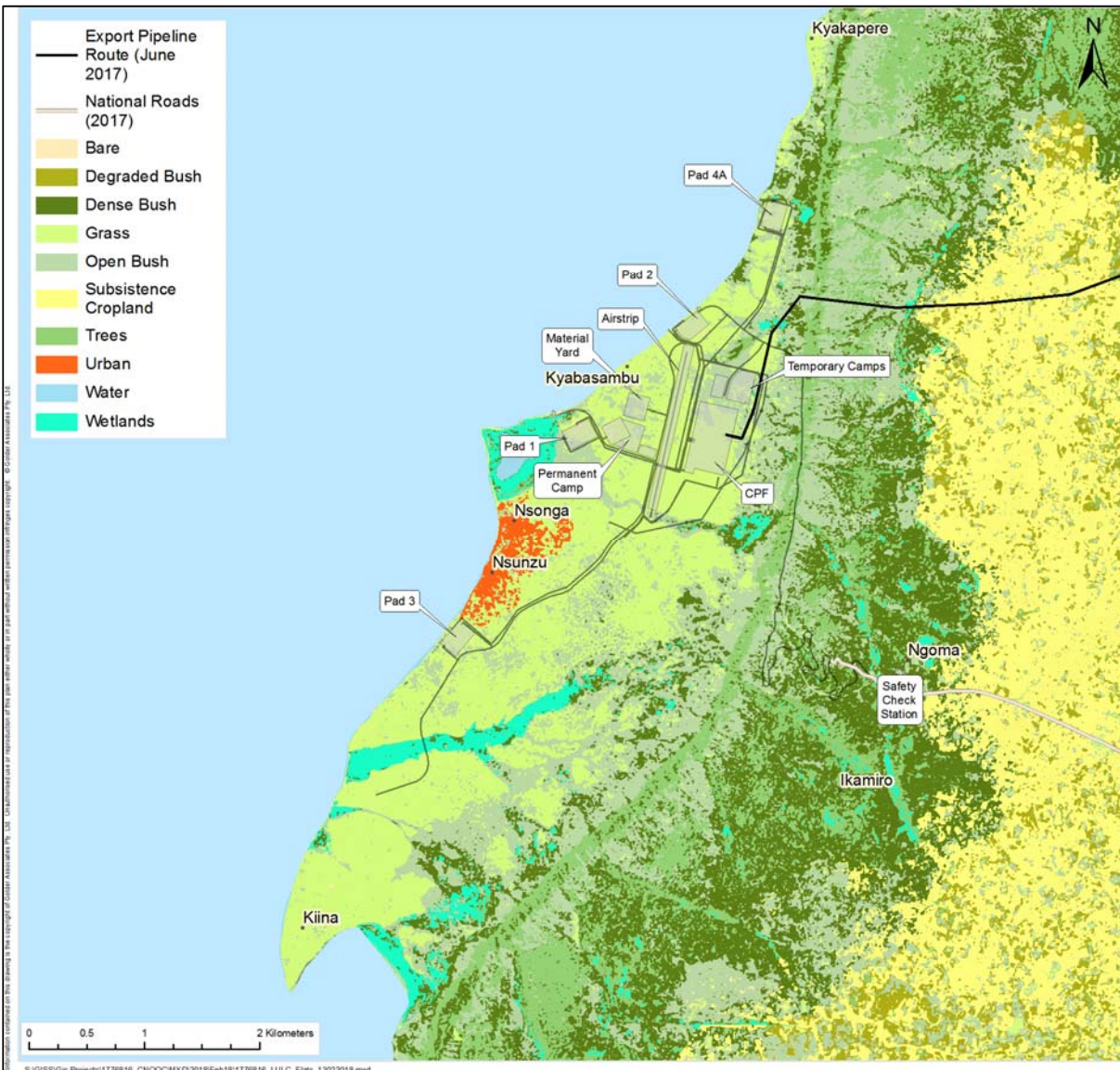

Figure 5: Kingfisher land cover and use.



3.3 Sensitive Receptors



Figure 6: Sensitive receptors.



Villages on the Buhuka Flats and other flats along the Lake Albert shoreline as well as on the escarpment were identified as possible sensitive receptors these include:

- Busigi;
- Ilkamiro;
- Kacunde;
- Kiina;
- Kyabasambu;
- Kyakapere;
- Kyenyanja;
- Ngoma;
- Nsonga;
- Nsunzu;
- Sangarao;
- Senjonjo; and,
- Ususa.

3.4 Atmospheric Dispersion Potential

In the assessment of the possible impacts from air pollutants on the surrounding environment and human

Meteorological characteristics of a site govern the dispersion, transformation and eventual removal of pollutants from the atmosphere. The extent to which pollution will accumulate or disperse in the atmosphere is dependent on the degree of thermal and mechanical turbulence within the earth's boundary layer. Dispersion comprises vertical and horizontal components of motion. The vertical component is defined by the stability of the atmosphere and the depth of the surface mixing layer. The horizontal dispersion of pollution in the boundary layer is primarily a function of the wind field. The wind speed determines both the distance of downwind transport and the rate of dilution as a result of plume "stretching". The generation of mechanical turbulence is similarly a function of the wind speed, in combination with the surface roughness. The wind direction and the variability in wind direction, determine the general path pollutants will follow, and the extent of cross-wind spreading.

Pollution concentration levels fluctuate in response to changes in atmospheric stability, to concurrent variations in the mixing depth, and to shifts in the wind field. Spatial variations, and diurnal and seasonal changes, in the wind field and stability regime are functions of atmospheric processes operating at various temporal and spatial scales. Atmospheric processes at macro-scales and meso-scales need therefore be taken into account in order to accurately parameterise the atmospheric dispersion potential of a particular area.

Parameters that need to be taken into account in the characterisation of meso-scale ventilation potentials include wind speed, wind direction, extent of atmospheric turbulence, ambient air temperature and mixing depth (Pasquill, Smith 1983, Godish 1990).



3.4.1 Boundary Layer Properties and Atmospheric Stability

The atmospheric boundary layer constitutes the first few hundred metres of the atmosphere and is directly affected by the earth's surface. The earth's surface affects the boundary layer through the retardation of air flow created by frictional drag, created by the topography, or as result of the heat and moisture exchanges that take place at the surface.

During the day, the atmospheric boundary layer is characterised by thermal heating of the earth's surface, converging heated air parcels and the generation of thermal turbulence, leading to the extension of the mixing layer to the lowest elevated inversion. These conditions are normally associated with elevated wind speeds, hence a greater dilution potential for the atmospheric pollutants.

During the night, radiative flux divergence is dominant due to the loss of heat from the earth's surface. This usually results in the establishment of ground based temperature inversions and the erosion of the mixing layer. As a result, night-time is characterised by weak vertical mixing and the predominance of a stable layer. These conditions are normally associated with low wind speeds, hence less dilution potential.

The mixed layer ranges in depth from a few metres during night times to the base of the lowest elevated inversion during unstable, daytime conditions. Elevated inversions occur for a variety of reasons, however typically the lowest elevated inversion occurs at night during winter months when atmospheric stability is typically at its maximum. Atmospheric stability is frequently categorised into one of six stability classes. These are briefly described in Table 9.

The atmospheric boundary layer is normally unstable during the day as a result of the turbulence due to the sun's heating effect on the earth's surface. The thickness of this mixing layer depends predominantly on the extent of solar radiation, growing gradually from sunrise to reach a maximum at about 5-6 hours after sunrise. This situation is more pronounced during the winter months due to strong night-time inversions and a slower developing mixing layer. During the night a stable layer, with limited vertical mixing, exists. During windy and/or cloudy conditions, the atmosphere is normally neutral.

Table 9: Atmospheric stability classes.

Designation	Stability Class	Atmospheric Condition
A	Very unstable	Calm wind, clear skies, hot daytime conditions
B	Moderately unstable	Clear skies, daytime conditions
C	Unstable	Moderate wind, slightly overcast daytime conditions
D	Neutral	High winds or cloudy days and nights
E	Stable	Moderate wind, slightly overcast night-time conditions
F	Very stable	Low winds, clear skies, cold night-time conditions

For elevated releases, the highest ground level concentrations would occur during unstable, daytime conditions. The wind speed resulting in the highest ground level concentration depends on the plume buoyancy. If the plume is considerably buoyant (high exit gas velocity and temperature) together with a low wind, the plume will reach the ground relatively far downwind. With stronger wind speeds, on the other hand, the plume may reach the ground closer, but due to the increased ventilation, it would be more diluted. A wind speed between these extremes would therefore be responsible for the highest ground level concentrations. In contrast, the highest concentrations for ground level, or near-ground level releases would occur during weak wind speeds and stable (night-time) atmospheric conditions.



3.5 Regional climate

Uganda is located in east Africa at latitudes of 2°S to 5°N, on the East African Plateau, its climate is tropical, but is moderated by its high altitude. Temperature vary little throughout the year, but the average temperatures increase in the south of the country as the elevation decreases towards the Sudanese plain. Average temperatures in the coolest regions of the south-west remain below 20°C, and reach 25°C in the warmest, northernmost parts.

Seasonal rainfall in Uganda is driven mainly by the migration of the Inter-Tropical Convergence Zone (ITCZ), a relatively narrow belt of very low pressure and heavy precipitation that forms near the earth's equator. The exact position of the ITCZ changes over the course of the year, migrating southwards through Uganda in October to December, and returning northwards in March, April and May. This causes the Uganda to experience two distinct wet periods – the 'short' rains in October to December and the 'long' rains in March to May. The amount of rainfall received in these seasons is generally 50-200mm per month but varies greatly, exceeding 300mm per month in some localities.

The movements of the ITCZ are sensitive to variations in Indian Ocean sea-surface temperatures and vary from year to year; hence the onset and duration of these rainfalls vary considerably inter-annually. One of the most well documented ocean influences on rainfall in this region is the El Niño Southern Oscillation (ENSO). El Niño episodes usually cause greater than average rainfalls in the short rainfall season (OND), whilst cold phases (La Niña) bring a drier than average season (Mc Sweeny, New, Lizcano et al 2010).

3.6 Meso Scale Meteorology

3.6.1 Wind Direction and Speed

Wind direction and wind speed records indicate a high incidence of strong winds especially in the Rift Valley. The prevailing winds commonly blow along the valley floor in a north-east to south-west direction or vice versa. Winds also blow across the Rift Valley in an east to west direction. On the escarpment and mountain slopes, prevailing wind-blow is largely multi-directional. The long-term wind speed records from the East African Meteorological Department (1975) indicate average annual wind speeds of 2.0m/s and 3.0m/s at 0600 hours and 1200 hours, respectively, for Butiaba; 1.5m/s and 2.5m/s, respectively, for Hoima and; 1m/s and 3m/s, respectively, for Kasese. The wind speed values indicated, therefore, represent conditions of moderate to strong or turbulent conditions. The average number of calms experienced in the area, are indicated to be experienced for 41 days at 0600 hours, and 14 days at 1200 hours, respectively, at Butiaba; 99 days and 27 days, respectively, for Hoima; 181 days and 44 days, respectively, for Kasese; and 99 days and 27 days, respectively, for Masindi. The general conclusion from these climatic figures is that for most of the year, the area experiences moderate to strong and gusty winds, increasing in the afternoon. Both wind speed and direction have important implications on oil exploration and production activities particularly the dispersion potential for oil pollutants (NEMA 2010).

3.6.2 Temperature and Humidity

The Albertine graben region lies astride the equator. The region experiences small annual variation in air temperatures; and the climate may be described as generally hot and humid, with average monthly temperatures varying between 27°C and 31°C. The temperature maxima's are consistently above 30°C and sometimes reach 38°C. Average minimum temperatures are relatively consistent and vary between 16°C and 18°C. The recorded lowest and highest monthly mean temperatures in the year vary along the Rift Valley: In Pamoti in Moyo, the lowest mean temperatures are recorded in August (22.6°C) while the highest are recorded in February (27.1°C). Southwards at Wadelai, the lowest mean temperatures are recorded in January (8.7°C) and the highest in February (39.0°C) indicating an extreme change in temperatures within a period of one month. At Butiaba, the lowest mean temperatures were recorded in September (18.0°C) and the highest in February (35.6°C). Further south at Kasese, the lowest mean temperatures were recorded in July (10.5°C) and the highest in February (36.0°). The high air temperatures result in high evaporation rates causing some parts to have a negative hydrological balance.

The relative humidity in the Albertine graben is higher during rain seasons with maximum levels prevalent in May. The lowest humidity levels occur in dry seasons with minimum levels occurring in December and



January. The average monthly humidity is between 60% and 80%. The relative humidity recorded at Wadelai at 0600 hours ranges between 70% in February and 88% in August while the record at 1200 hours ranged between 35% from January to February and 55% from August to September. The average humidity recorded at 0600 hours for Butiaba ranged between 67% in January and 80% in August while at 1200 hours, the humidity records ranged between 66% in January and 71% in October. At Kasese, the average humidity recorded at 0600 hours ranged between 79% in January and February and 85% from April to July, while records at 1200 hours ranged between 49% in July and 61% in November. Relative humidity records for Moyo and the areas in the extreme south-west of the graben in Rukungiri and Kanungu are not available. It can be concluded therefore, that variation in relative humidity is generally moderate, except for Wadelai where both low and high relative humidity figures have been recorded (35% and 88% respectively) (NEMA 2010).

3.6.3 Rainfall

The Albertine graben has a sharp variation in rainfall amounts, mainly due to variations in the landscape. The landscape ranges from the low lying Rift Valley floor to the rift escarpment, and the raised mountain ranges. The highest landscape is the mountain ranges of Rwenzori, the Rwenzori Mountains towering at over 5000m above mean sea level (amsl).

The Rift Valley floor lies in a rain shadow of both the escarpment and mountains, and has the least amount of rainfall average of less than 875mm per annum much lower than that of the highland area. Rainfall records by Directorate of Water Resources Management indicate that Moyo in the extreme north-east received an annual rainfall mean of 1174.8mm over a seven year period between 2003 and 2009. Over the period the highest annual mean rainfall was recorded in 2006 (1593.9mm) while the lowest was recorded in 2004 (623.6mm) indicating a high variation range in the mean annual rainfall received. Butiaba around Lake Albert in the centre north-east receives 750mm, while Kasese in the central part of the graben receives a slightly higher mean rainfall of 970mm. No records are available for areas in the extreme south-western parts of the graben in Rukungiri and Kanungu. However, the area similarly receives rainfall amounts lower than that in the highland area flanking the Rift Valley. On the highland areas of the rift escarpment, rainfall averages increase largely due to orographic influence. For example, Masindi receives an annual average rainfall of 1,359mm, while Hoima receives 1435mm.

Rainfall amounts are even higher on the slopes of the Ruwenzori's, in most cases increasing to over 1500mm. There is however, a serious lack of coverage of climatic measuring instrumentation, which is a common problem in mountainous regions worldwide. As a result of this, information on the spatial distribution of rainfall in the Rwenzori Mountains remains scanty.

There is also scanty rainfall information in the graben but a high variation in the rainfall received both along and across the Rift Valley. Mean Rainfall amounts in the Murchison Falls Conservation Area for instance vary from 1,500mm per year at Chobe in the east to about 1,100mm at Paraa on the western part of the Rift Valley. Likewise, the mean annual rainfall recorded at Pamoti (Moyo District Farm Institute) in Moyo from 2003 to 2009 was 1174.8mm. The long-term mean rainfall amount recorded at Wadelai in Nebbi is 1,029mm, 750mm at Butiaba and 970mm at Kasese; giving a mean range of 425mm between the most northerly and southerly points where rainfall has been measured in the rift system. There is also significant seasonal variation in the rainfall pattern, mainly as a result of variation in factors influencing rainfall and especially the periodic shifting of the Inter-Tropical Convergence Zone (ITCZ) and the wind blows from the Atlantic Ocean through the Congo basin in central Africa. In the northern part of the region, there are two seasons of high rainfall, associated with the passing of the ITCZ over the region. Generally, rain occurs in all months, but with two peaks occurring between April and May, and August through to October, with two relatively drier spells around January and June (NEMA 2010).

3.7 Local meteorology

Meteorology has been measured on the Buhuka Flats since 2010, and apart from the period from March 2012 to December 2012 monitoring has been continuous. The meteorological station is situated in Bugoma and measures the following parameters:

- Wind direction and wind speed;



- Temperature; and
- Rainfall.

3.7.1 Wind Direction and Speed

Wind direction data for the Buhuka Flats is presented in Figure 7 to Figure 9 and wind speed data in Figure 10 to Figure 11. Data for 2012 is not displayed because of the limited monitoring that took place during that year. Wind speed data from 2013 is also not displayed, it is suspected that this instrument has been damaged; the data has therefore been rejected.

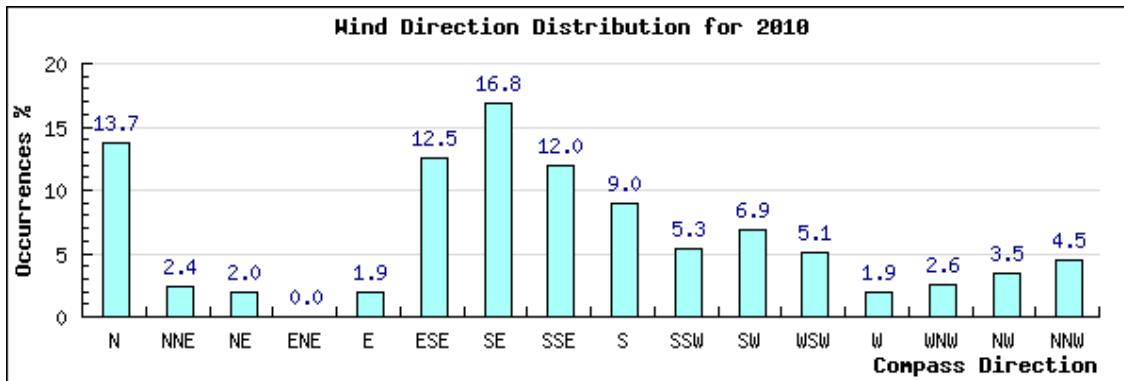

Figure 7: Buhuka Flats – Wind Direction 2010 (iWeather 2014).

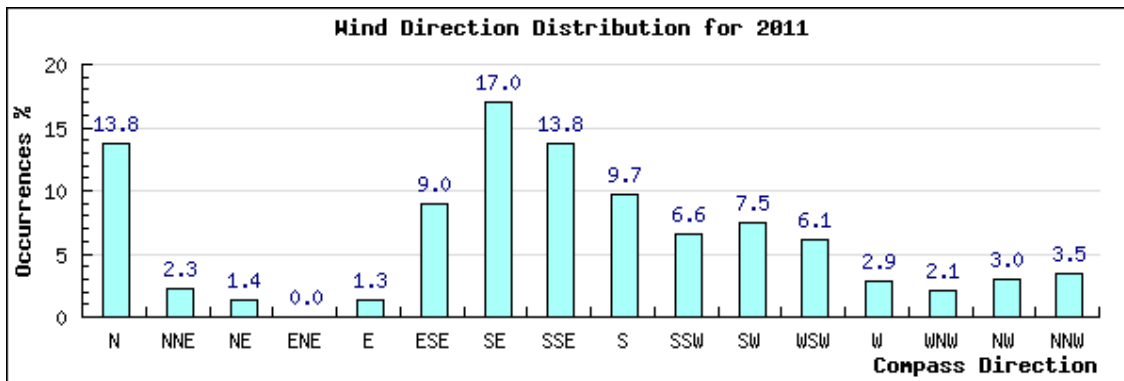

Figure 8: Buhuka Flats – Wind Direction 2011 (iWeather 2014).



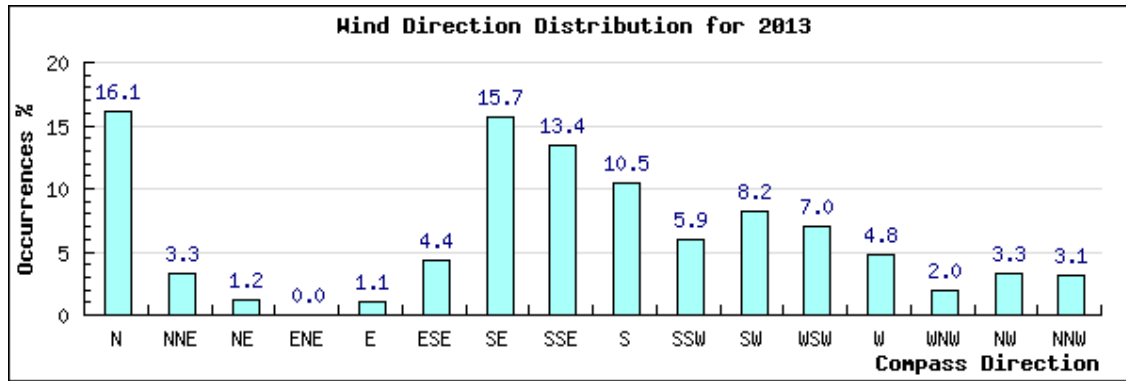

Figure 9: Buhuka Flats – Wind Direction 2013 (iWeather 2014).

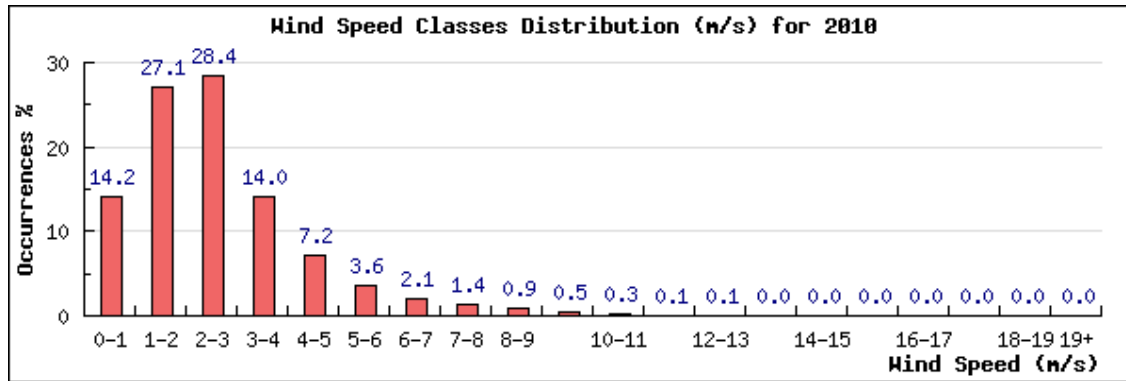

Figure 10: Buhuka Flats – Wind Speed 2010 (iWeather 2014).

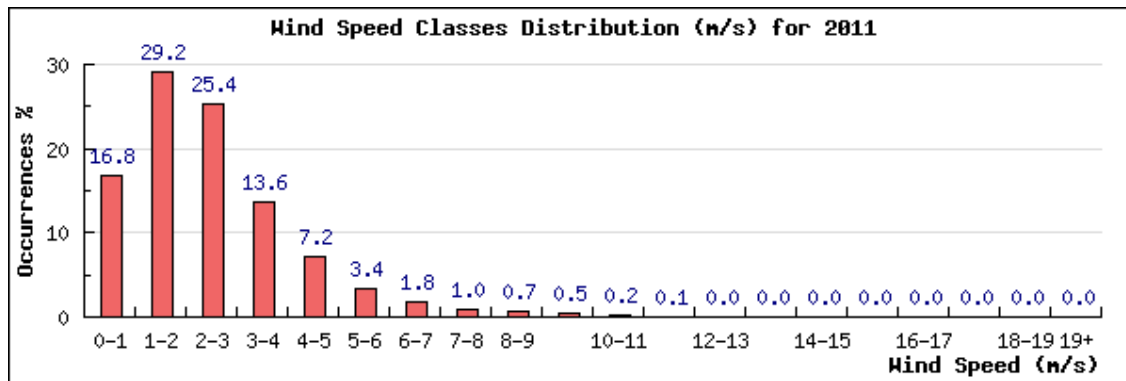

Figure 11: Buhuka Flats – Wind Speed 2011 (iWeather 2014).





3.7.2 Temperature

Average monthly temperature for the Buhuka Flats is displayed in Figure 12 to Figure 15.

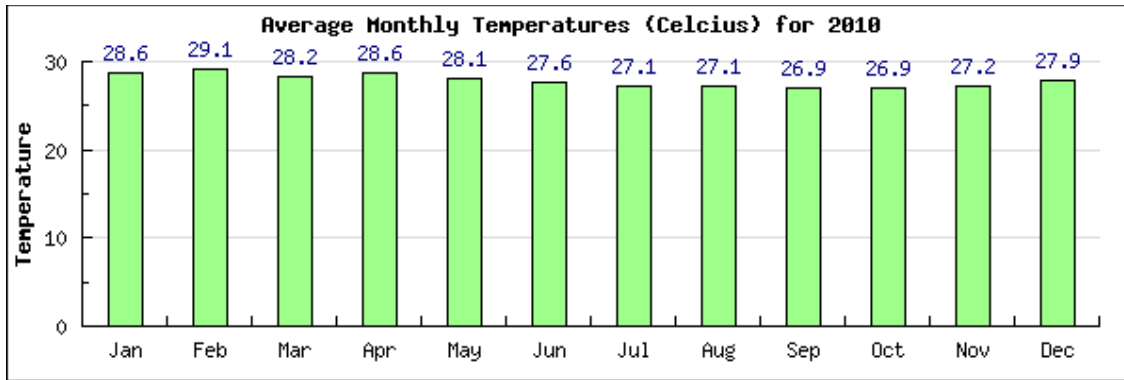

Figure 12: Buhuka Flats – Temperature 2010 (iWeather 2014).

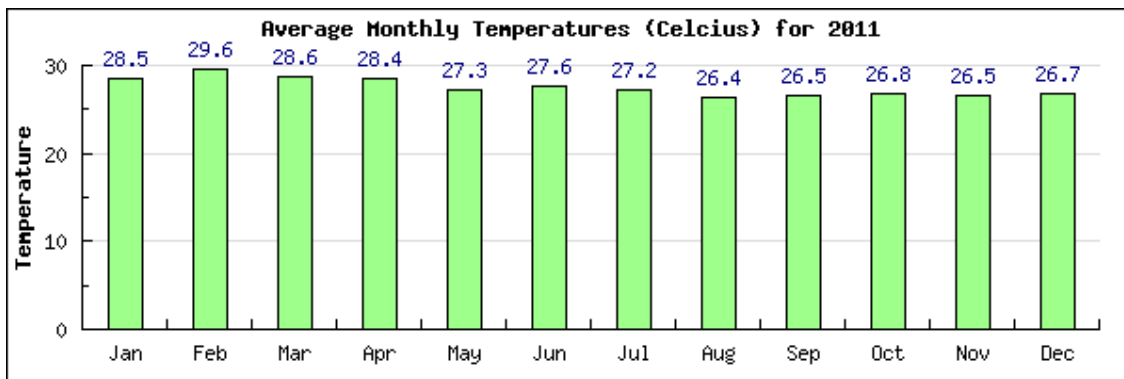

Figure 13: Buhuka Flats – Temperature 2011 (iWeather 2014).

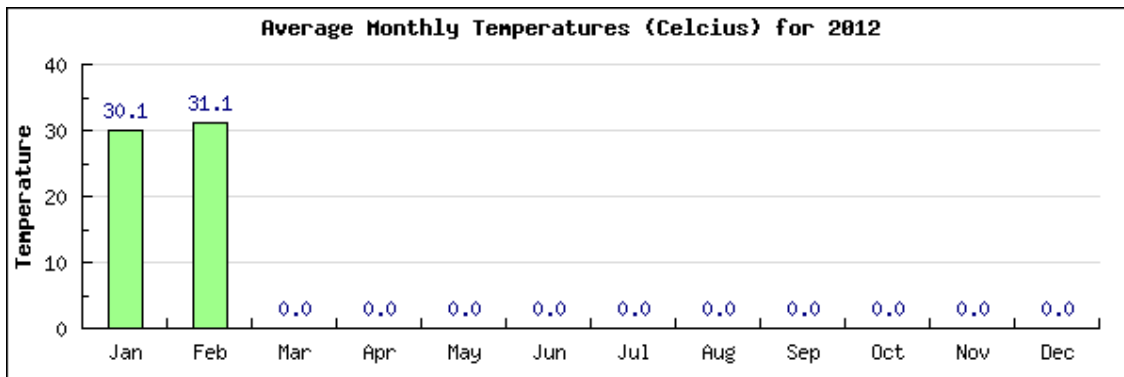

Figure 14: Buhuka Flats – Temperature 2012 (iWeather 2014).



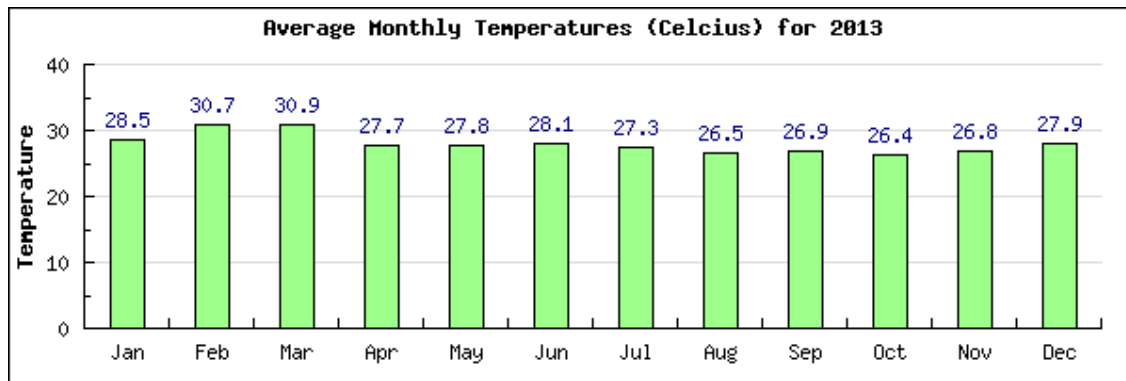

Figure 15: Buhuka Flats – Temperature 2013 (iWeather 2014).

3.7.3 Rainfall

Monthly rainfall for the Buhuka Flats is provided in Figure 16 to Figure 19.

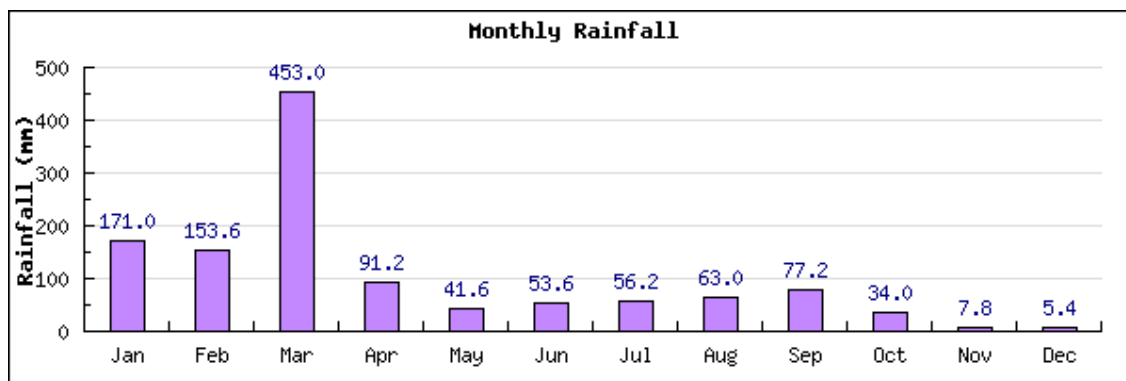

Figure 16: Buhuka Flats – Rainfall 2010 (iWeather 2014).

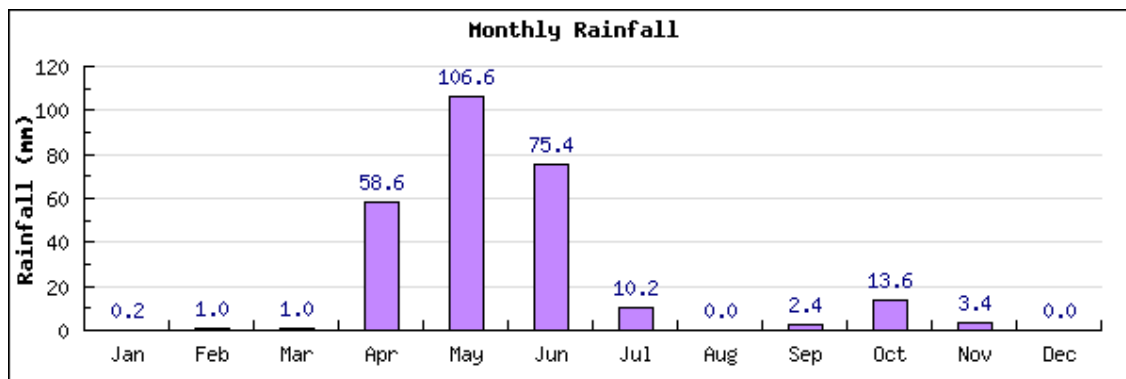

Figure 17: Buhuka Flats – Rainfall 2011 (iWeather 2014).



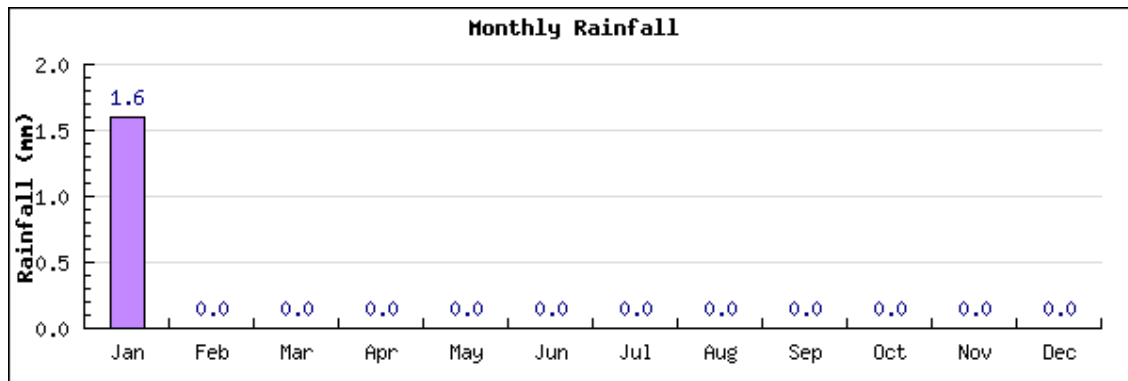

Figure 18: Buhuka Flats – Rainfall 2012 (iWeather 2014).

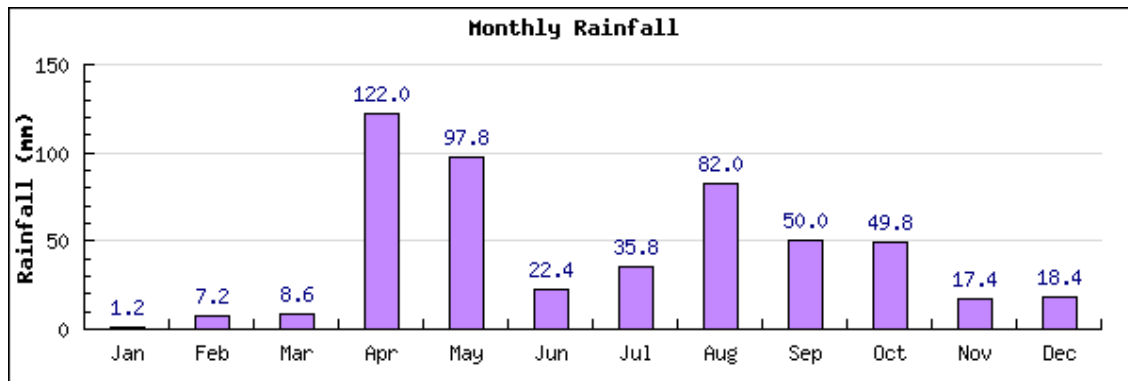

Figure 19: Buhuka Flats – Rainfall 2013 (iWeather 2014).





3.8 Modelled meteorology

The Penn State University (PSU) / National Centre for Atmospheric Research (NCAR) meso-scale model is a limited-area, non-hydrostatic or hydrostatic (Version 2 only), terrain-following sigma-coordinate model designed to simulate or predict meso-scale and regional-scale atmospheric circulation. It has been developed at PSU and NCAR as a community meso-scale model and is continuously being improved by contributions from users at several universities and government laboratories. The Fifth-Generation PSU / NCAR Meso-scale Model is known as MM5 (PSU/NCAR 2014).

MM5 data for the Buhuka Flats for period 01 January 2011 to the 31 December 2013 was obtained for the purposes of this study, the data is assumed and expected to be representative of the actual meteorological conditions in EA3A.

3.8.1 Wind Roses

Predominant winds blew from the two sectors: SE to SSW (46% of the time); and NW (6% of the time). The average wind speed was 2.90m/s with 10% calms (Figure 20). Figure 21 shows diurnal variations in wind field, and Figure 22 seasonal variations.

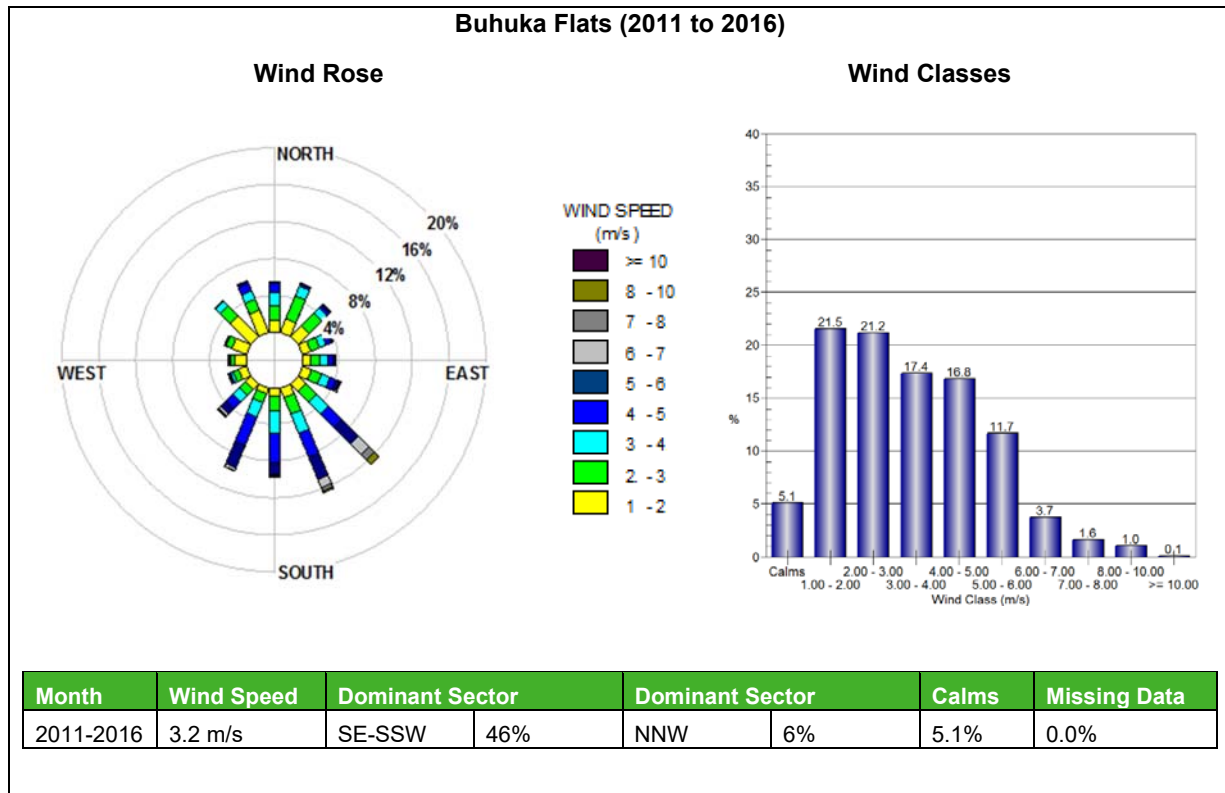

Figure 20: Period Wind Rose – Buhuka Flats 2011 - 2016.



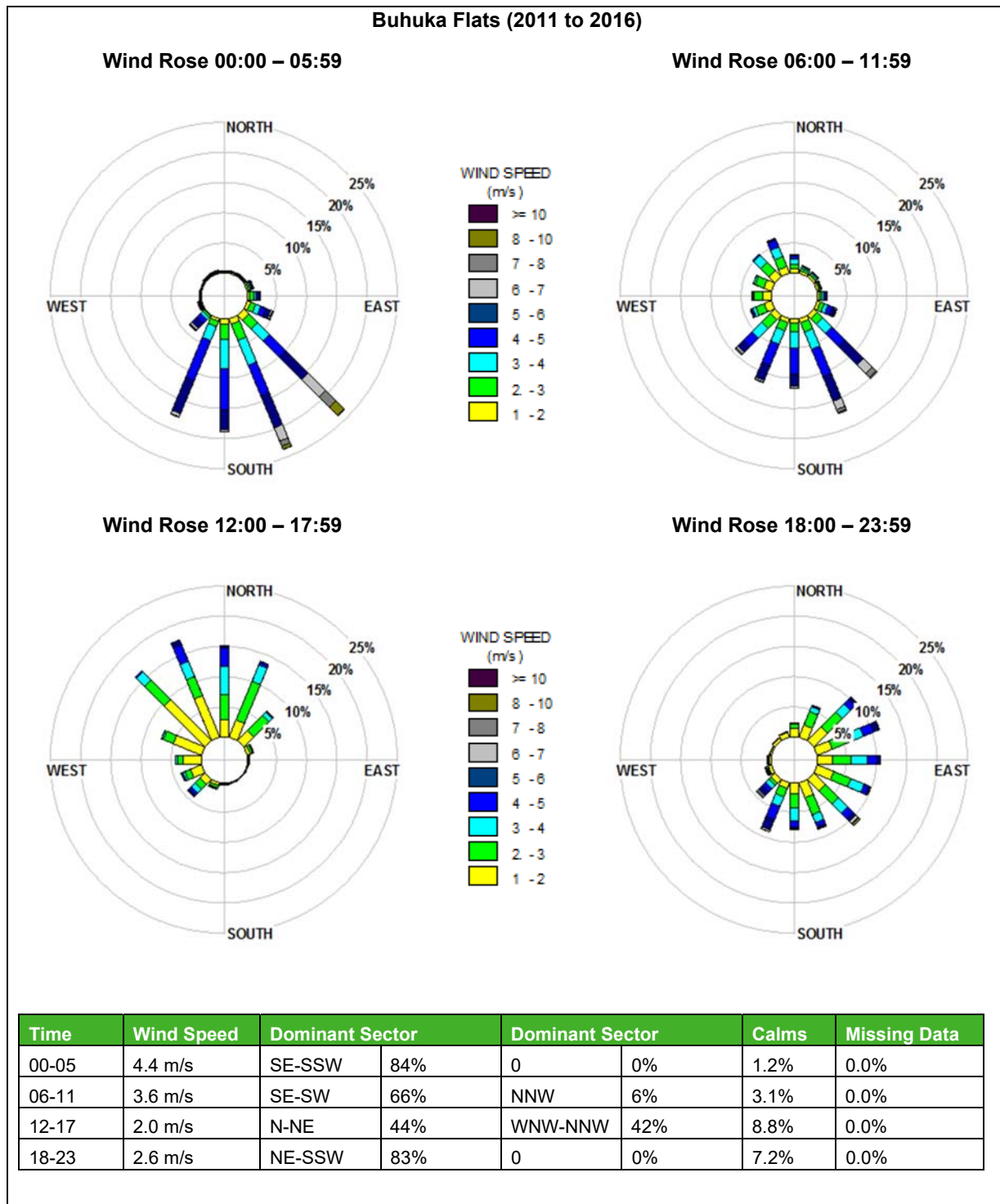

Figure 21: Diurnal Wind Roses – Buhuka Flats 2011 - 2016.



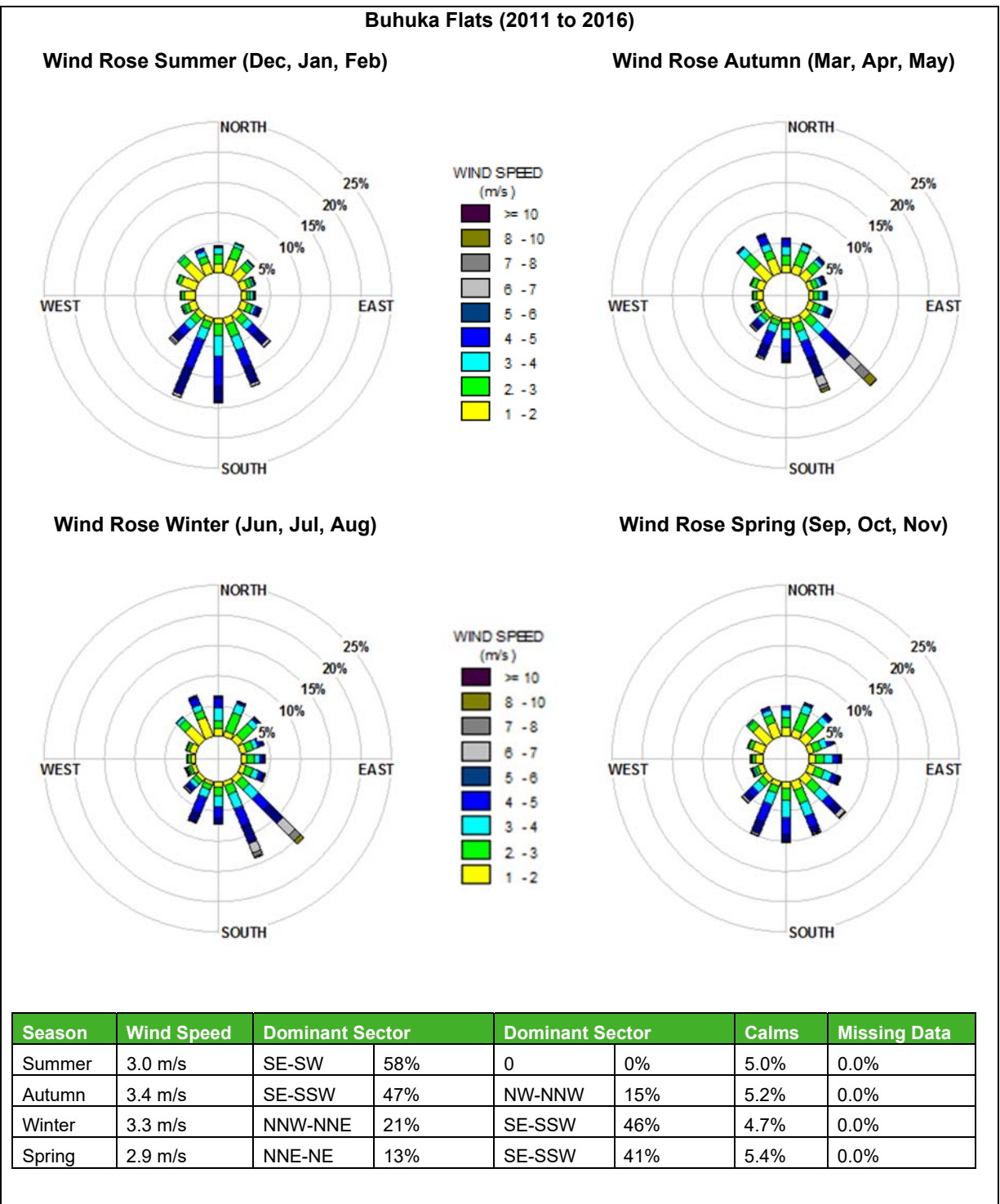

Figure 22: Seasonal Wind Roses – Buhuka Flats 2011 - 2016.





3.8.2 Meteorological Cross Check

The MM5 data and valid local data overlapped in 2011 (Figure 23). A comparison of the two data sets, with correction for calms, produced a correlation coefficient (r) of 0.65. The following general categories indicate a quick way of interpreting a calculated r value:

- 0.0 to 0.2 very weak to negligible correlation;
- 0.2 to 0.4 weak, low correlation (not very significant);
- 0.4 to 0.6 moderate correlation;
- 0.6 to 0.8 strong, high correlation; and,
- 0.8 to 1.0 very strong correlation.

The MM5 data is therefore deemed representative of the local meteorology.

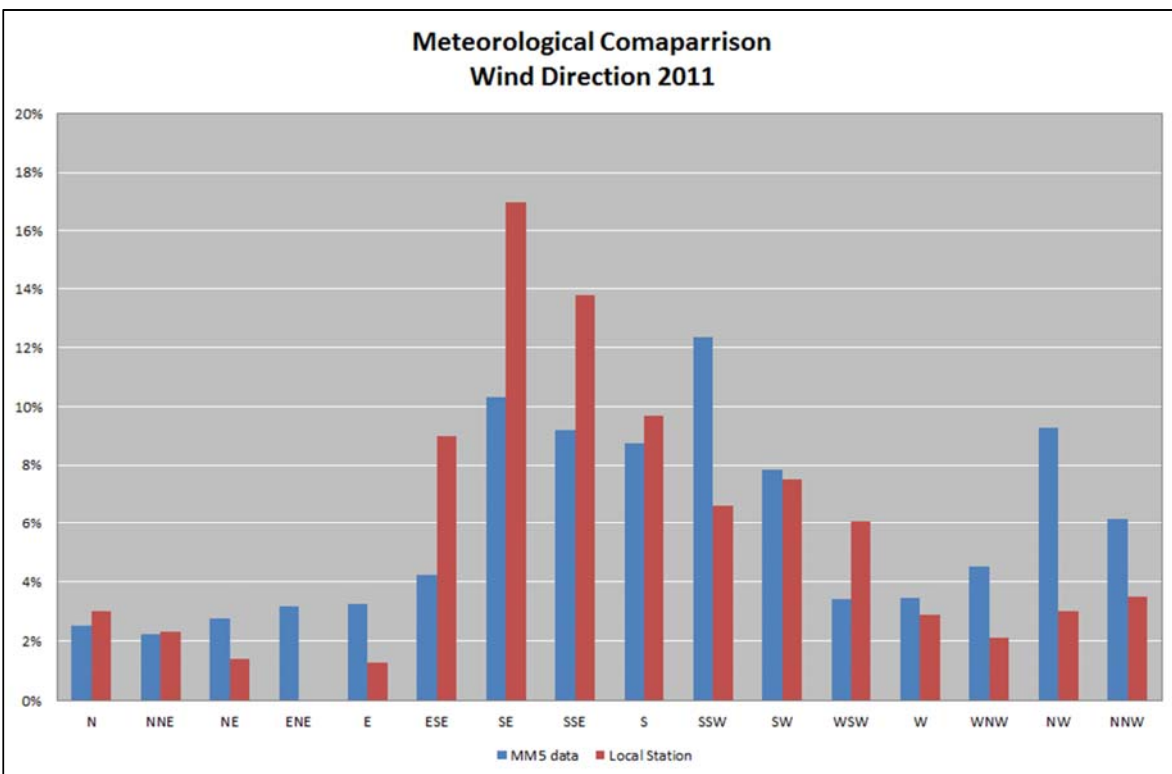

Figure 23: Meteorological cross check.





3.9 Ambient Air Quality Overview

Current air quality in EA3A was qualitatively assessed based on the local sources identified and the anticipated emissions thereof.

Potential sources of air pollution were identified to include:

- Agricultural activities;
- Mining activities;
- Oil Extraction and Refining;
- Domestic fuel burning;
- Biomass burning;
- Vehicle emissions (tailpipe and entrained emissions);
- Paved roads; and
- Unpaved roads.

3.9.1 Agricultural Activities

Land cover on the flats is predominantly grass and bush; subsistence farming is the dominant agricultural activity. The escarpment is covered by forest and bush land, it is often used as grazing area for livestock. The plateau contains a mixture of forest; bush land and farmland, there are both subsistence and commercial farms (tea).

Agricultural emissions are not anticipated to significantly influence the air quality in the area although particulate emissions may increase during the dry periods from fallow fields.

3.9.2 Mining Activities

The Albertine graben has a number of economic mineral resources, although there is not much detailed and accurate information on about the location and extent of the mineral deposits (NEMA 2010).

Mining activity within EA3A is limited and therefore not expected to have a significant on air quality.

3.9.3 Oil Extraction and Refining

Exploration and production activities so far indicate that the oil potential in EA3A is significant. The estimated scale of oil discoveries in the region as well as government policy on energy suggests the need for the construction of a fully-fledged oil refinery preferably within the Albertine graben. The preferred location of the refinery implies the need for construction of pipelines to transport crude and processed oil between production wells, processing facilities, refinery and markets (NEMA 2010).

Although there is currently no commercial oil extraction or refining in EA3A, indications are that there will most likely be in the near future. These activities can have a significant detrimental effect on air quality without appropriate mitigation measures. Potential air impacts that may occur as a result of the oil extraction and refining may be attributable to increased concentrations of:

- Criteria air pollutants (CAP), these include:
 - Sulphur Dioxide (SO₂);
 - Nitrogen Oxides (NO_x);
 - Carbon Monoxide (CO);
 - Particulate Matter (PM₁₀, PM_{2.5} and TSP); and



- Ozone (O₃).
- Toxic air contaminants (TAC), that cause or may cause cancer or other serious health effects, such as:
 - Hydrogen Sulphide;
 - Benzene;
 - Toluene;
 - Ethyl benzene;
 - Xylene; and
- Greenhouse gases (GHG), including:
 - Methane (CH₄); and,
 - Carbon Dioxide.

3.9.4 Domestic Fuel Burning

The majority of the population in the Albertine graben use wood fuel as the most dominant source of energy. Kerosene or paraffin is used for lighting and less than 3% of all households have access to electricity supply. However, firewood has become scarce and most people have resorted to using charcoal which is often imported from elsewhere and is very expensive. At the moment, most of the Rift Valley area is not connected to the national grid. Individual companies involved in oil exploration have therefore had to invest in generators (NEMA 2010).

Domestic fuel burning of wood includes respirable particulates, nitrogen dioxide, carbon monoxide, polycyclic aromatic hydrocarbons, particulate benzo (a) pyrene and formaldehyde. The main pollutants emitted from the combustion of paraffin are nitrogen dioxide, particulates, carbon monoxide and polycyclic aromatic hydrocarbons.

3.9.5 Biomass Burning

Biomass burning may be described as the incomplete combustion process of natural plant matter with carbon monoxide, methane and nitrogen dioxide being emitted during the process. During the combustion process, approximately 40% of the nitrogen in biomass is emitted as nitrogen, 10% remains in the ashes and it is assumed that 20% of the nitrogen is emitted as higher molecular weight nitrogen compounds. In comparison to the nitrogen emissions, only small amount of sulphur dioxide and sulphate aerosols are emitted. With all biomass burning, visible smoke plumes are typically generated. These plumes are created by the aerosol content of the emissions and are often visible for many kilometres from the actual source of origin.

The extent of emissions liberated from biomass burning is controlled by several factors, including:

- The type of biomass material;
- The quantity of material available for combustion;
- The quality of the material available for combustion;
- The fire temperature; and
- Rate of fire progression through the biomass body.

General wild fires represent significant sources of combustion-related emissions associated with agricultural areas.



3.9.6 Vehicle emissions

Air pollution generated from vehicle engines (including motorised boats) may be grouped into primary and secondary pollutants. Primary pollutants are those emitted directly to the atmosphere as tail-pipe emissions whereas, secondary pollutants are formed in the atmosphere as a result of atmospheric chemical reactions, such as hydrolysis, oxidation, or photochemical reactions. The primary pollutants emitted typically include carbon dioxide (CO₂), carbon monoxide (CO), hydrocarbons (including benzene, 1,2-butadiene, aldehydes and polycyclic aromatic hydrocarbons), sulphur dioxide (SO₂), oxides of nitrogen (NO_x) and particulates. Secondary pollutants formed in the atmosphere typically include nitrogen dioxide (NO₂), photochemical oxidants such as ozone, hydrocarbons, sulphur acid, sulphates, nitric acid, sulphates and nitrate aerosols.

The quantity of pollutants emitted by a vehicles depend on specific vehicle related factors such as vehicle weight, speed and age; fuel-related factors such as fuel type (petroleum or diesel), fuel formulation (oxygen, sulphur, benzene and lead replacement agents) and environmental factors such as altitude, humidity and temperature.

Given the population densities in the region, it is not anticipated that the contribution vehicle and boat exhaust emissions to air pollutant will be insignificant.

3.9.7 Wheel generated Dust on Unpaved Roads

When vehicles travel on unpaved roads; the force of the wheels on the road surface causes pulverization of surface material. Particles are lifted and dropped from the rolling wheels, and the road surface is exposed to strong air currents in turbulent shear with the surface. The turbulent wake behind the vehicle continues to act on the road surface after the vehicle has passed.

Vehicle entrainment of particulates from unpaved roads is anticipated to be one of the dominant sources of particulate emissions in the region. Special attention in regards to mitigation of such emissions will have to be undertaken to prevent the deterioration of ambient air quality due to increased traffic.

3.9.8 Wheel Generated Dust on Paved Roads

Particulate emissions occur whenever vehicles travel over a paved surface such as a road or parking lot; these emissions are due to direct emissions from vehicles in the form of exhaust, brake wear and tire wear emissions and re-suspension of loose material on the road surface. In general terms, re-suspended particulate emissions from paved roads originate from, and result in the depletion of, the loose material present on the surface (i.e., the surface loading). In turn, that surface loading is continuously replenished by other sources. At industrial sites, surface loading is replenished by spillage of material and track-out from unpaved roads and staging areas. Various field studies have found that public streets and highways, as well as roadways at industrial facilities, can be major sources of the atmospheric particulate matter within an area.

Because the total coverage of tarmac road infrastructure in the area is limited vehicle entrainment of particulates from paved roads is anticipated to insignificant.

3.9.9 Summary of the Regional Air Quality

Based on the available information and the data analysed, it is anticipated that the regional air quality in the proposed project area is good, although may deteriorate periodically as a result of biomass burning.

3.10 Health Effects of Exposures to Various Pollutants

3.10.1 Nitrogen Dioxide (NO₂)

Nitrogen dioxide is a reddish-brown gas that can irritate the eyes, nose and throat and cause shortness of breath.

3.10.2 Sulphur Dioxide (SO₂)

Sulphur dioxide is a colourless gas that smells like burnt matches. It can be oxidized to sulphur trioxide, which in the presence of water vapour is readily transformed to sulphuric acid mist. Health effects caused by





exposure to high levels of SO₂ include breathing problems, respiratory illness, changes in the lung's defences, and worsening respiratory and cardiovascular disease.

3.10.3 Particulates (TSP, PM₁₀, PM_{2.5} and dust fallout)

Atmospheric particulate matter also known as particulates or particulate matter (PM), are tiny pieces of solid or liquid matter associated with the earth's atmosphere. They are suspended in the atmosphere as atmospheric aerosol. Sources of particulate matter can be man-made or natural. They can adversely affect human health and also have impacts on climate and precipitation. Subtypes of atmospheric particle matter include total suspended particulates (TSP), respirable suspended particle (RSP; particles with diameter of 10µm or less), fine particles (diameter of 2.5 µm or less), ultrafine particles, and soot.

3.10.4 Hydrogen Sulphide (H₂S)

Hydrogen sulphide is considered a broad-spectrum poison, meaning that it can poison several different systems in the body, although the nervous system is most affected. The toxicity of H₂S is comparable with that of hydrogen cyanide or carbon monoxide. It forms a complex bond with iron in the mitochondrial cytochrome enzymes, thus preventing cellular respiration.

Exposure to H₂S has the following effects:

- 0.00047ppm or 0.47ppb is the odour threshold;
- 10ppm is the United States Occupational Safety Health Administration (OSHA) permissible exposure limit (PEL) (8 hour time-weighted average);
- 10–20ppm is the borderline concentration for eye irritation;
- 20ppm is the acceptable ceiling concentration established by OSHA;
- 50ppm is the acceptable maximum peak above the ceiling concentration for an 8 hour shift, with a maximum duration of 10 minutes;
- 50–100ppm leads to eye damage;
- At 100–150ppm the olfactory nerve is paralyzed after a few inhalations, and the sense of smell disappears, often together with awareness of danger;
- 320–530ppm leads to pulmonary oedema with the possibility of death;
- 530–1000ppm causes strong stimulation of the central nervous system and rapid breathing, leading to loss of breathing;
- 800ppm is the lethal concentration for 50% of humans for 5 minutes exposure (LC50); and,
- Concentrations over 1000 ppm cause immediate collapse with loss of breathing, even after inhalation of a single breath. Cortical pseudo laminar necrosis; degeneration of the basal ganglia and cerebral oedema have also been shown (WHO, 2000).

3.10.5 Volatile Organic Compounds (VOC's)

Volatile organic compounds (VOCs) are organic chemicals that have a high vapour pressure at ordinary room temperature. Their high vapour pressure results from a low boiling point, which causes large numbers of molecules to evaporate or sublime from the liquid or solid form of the compound and enter the surrounding air. Harmful VOCs typically are not acutely toxic, but have compounding long-term health effects.

3.10.6 Summary

A summary of the health effects resulting from acute and chronic exposures to various is presented in Table 10 below.



Table 10: Acute and chronic health effects associated with exposure to the primary pollutants of concern.

Pollutant	Acute exposure	Chronic exposure
Carbon Monoxide	Severe hypoxia , can lead to death Headaches, nausea & vomiting Muscular weakness Shortness of breath	Neurological deficits and damage
Particulate matter	Airway allergic inflammatory reactions & a wide range of respiratory problems Increase in medication usage related to asthma, nasal congestion and sinuses problems Adverse effects on the cardiovascular system Increase in hospital admissions Increase in mortality	Increase in lung problems with lower respiratory symptoms Reduction in lung function in children and adults Increase in chronic obstructive pulmonary disease Reduction in life expectancy Reduction in lung function development
Sulphur dioxide	Reduction in lung function Respiratory symptoms (wheeze and cough) Increase in hospital admissions Increase in mortality	Increase in respiratory symptoms Reduction in lung function, especially in asthmatics and children Reduction in life expectancy Increase in mortality
Nitrogen dioxide	Effects on pulmonary function, especially in asthmatics Increase in airway allergic inflammatory reactions Increase in hospital admissions Increase in mortality	Reduction in lung function Increased probability of respiratory symptoms Reduction in life expectancy Increase in mortality
Benzene	Adverse effects on the cardiovascular system and central nervous system Increase in mortality	Neurological damage Damage to cardiovascular systems Reduction in life expectancy Increased prevalence of carcinomas in the community Increase in mortality



4.0 IMPACT ASSESSMENT

4.1 Development Description and Proposed Infrastructures



Figure 24: Project main infrastructure.





The Kingfisher oilfield comprises of four onshore well pads where all the development wells will be drilled. Among those four well pads, three currently exist and require upgrade to meet requirements for oil production. The well-fluids shall be transported to a Central Processing Facility (CPF) via flowlines from individual well pads. The well-fluids shall be processed in the CPF to separate formation water and associated gas from the oil phase. The stabilized crude will be transferred about 50km through a pipeline to Kabaale, where the refinery will be located.

For the field development, CNOOC will build a range of producing and supporting facilities to achieve 40,000 barrels of oil per day. The subsurface construction will include a total of 40 wells (27 production wells and 13 injection wells); and the surface construction will include well-pads, production flow lines and water injection flow lines, an oil export pipeline, a central processing facility, a lake water extraction station, camps, a jetty, an airstrip and access roads among others. The proposed main infrastructures for the Kingfisher Project are described in the sections below and illustrated in Figure 24.

For the first year of development, the field production target is to reach 20,000 BOPD, and it is planned to use the two re-completed existing wells plus 5 producers (two of them will be inject water one year later) and 1 injector. At the start of the second year the target was raised to 30,000 BOPD, during which a re-completed existing well, further 5 producers (one of them will inject water one year later) and 1 injector will be added. Then, with 5 producers and 2 injectors coming on stream, the third year target was set at 40,000 BOPD and maintained as a plateau. Thereafter, another 18 wells will be brought into production to sustain plateau.

The annual produced oil and water volumes over 25 years for the base case development scenario are illustrated in Figure 25 below.

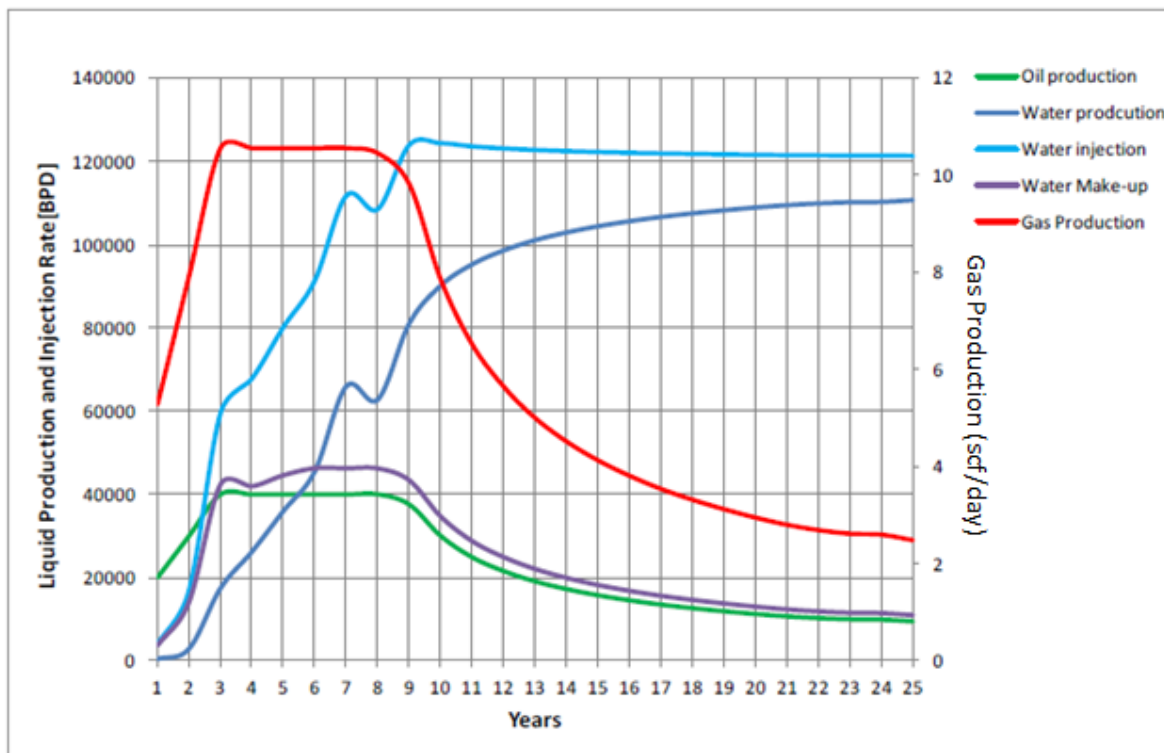

Figure 25: Production profiles for the Kingfisher oil field.

The 40,000 BOPD plateau can be sustained for almost 6 years, before increasing water cut renders the wells incapable of sustaining the target oil rates. Total fluid off-take reaches a maximum 120,000BLPD in the tenth year.



The total lifespan of Kingfisher field is 25 years.

4.1.1 Well pads for drilling and production

A base case development scenario of 40 wells has been identified. The final development will at least consist of 27 production wells and 13 water injection wells. It is proposed that all the wells will be drilled and completed from onshore utilizing the four well pads including three (3) existing exploration well pads. It should be noted that the onshore well count includes the three existing and suspended wells (Kingfisher-1, Kingfisher-2 and Kingfisher-3) which will be recompleted as production wells.

4.1.1.1 Well pad locations

Well pad coordinates (existing and proposed) are presented in Table 11; the locations of the pads are indicated in Figure 24.

Table 11: Existing and proposed well pads co-ordinates.

Table with 5 columns: Description, X (UTM 36 N m), Y (UTM 36 N [m]), Z (Elevation [m]), and Size (m). It lists Well Pad 1, 2, 3, and 4A with their respective coordinates and elevations.

4.1.1.2 Well pads for drilling

All 40 wells are proposed to be drilled from five onshore well pads: Pad 1, Pad 2, Pad 3, and Pad 4A. Amongst those well pads, Pad 1, Pad 2 and Pad 3 are already existing pads. A typical pad for drilling will be approximately 200m by 100m in size, these will be fenced facilities.



Figure 26: Example of a well pad at drilling stage.

During the drilling phase, a typical well pad will include a rig and auxiliary facilities such as such as drill wastes pits, a fuel tank storage area, a drilling fluids preparation area, mud tank, flare pits for emergency use, control rooms and fence. All five well pads including the three existing well pads will be constructed and / or upgraded to meet development well drilling requirements.

4.1.1.3 Well drilling

All the wells will generally be drilled using synthetic based muds from the pads down to the turning point and then directed towards the subsurface target as indicated in Figure 27. The wells will be drilled to a depth of more than 2000m, below Lake Albert.





There are currently three exploration/appraisal wells on Kingfisher which have been suspended following the well tests conducted. These wells were drilled as deviated wells out under the lake to intersect their reservoir targets from three drilling pads which were constructed on the shore of Lake Albert.

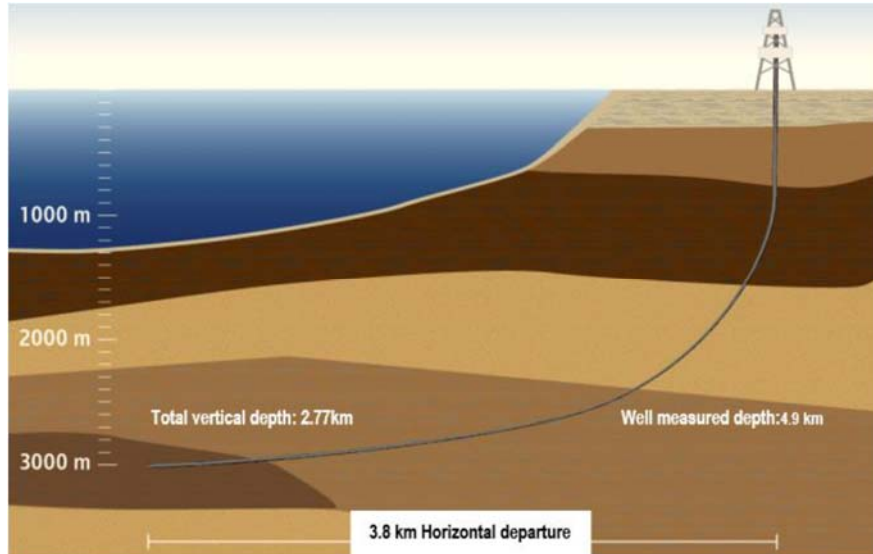

Figure 27: An illustration of directional drilling.

The following rig specifications or similar can be used as a basis during the tendering phase for a capability to drill the aforementioned wells:

- Mast: 450mt;
- Draw works: 2000HP, mechanical and electrical breaking systems with regenerative breaking;
- Top Drive: 450mt, >46,300ft.lbs, 150 rpm;
- Mud Pumps: 3 x 1,600 HP;
- Tank System: 600m³ active, kill mud 20m³;
- Pressure Control: minimum 5,000 psi BOP with 2,000 psi annular, mud gas separator;
- Power Pack: diesel generators, 6,000KW; and
- Drilling pipe: 5-1/2" or 5-7/8".

Normally it takes about 2~4 months to drill one well depending on measured depth and the deviation angel of the well. Well pad construction will be prior to the drilling operations.

4.1.1.4 Well pads for oil production

After well completion, the rig and the auxiliary facilities will be removed and feeder field pipeline will be installed to conduit the crude from the well to CPF. Some minor adjustments in the well configuration design may be adopted to factor in the infrastructural changes. Normally, each well pad comprises:

- Production and water injection manifolds;
- Production and test MPFM;
- Pig Launcher/Receiver;



- Chemical injection system;
- Closed drain system; and
- Technical room to accommodate instrumentation, telecom, and electricity devices etc.



Figure 28: A well head (left) and production manifold (right) (for illustration).

A production manifold shall be installed at each well site to gather produced fluids from the production choke valve on each Christmas tree (well head) via the individual well flowline. A test manifold shall also be provided to allow well testing to occur without interrupting production. The individual well flowlines shall be provided with manual block valves to divert produced fluids from production to test manifolds.

A water injection manifold shall be installed at each well site to deliver high pressure water for injection to the water injection choke valve on the Christmas tree via individual well flowlines. The individual well flowlines shall be provided with a manual block valve and a flowmeter.

All individual well flowlines and manifolds shall be heat traced and insulated for heat conservation. Its design shall allow for drilling rig to move between different slots without shutting down production from the well pad. The well pads are designed as normally unmanned. Firefighting philosophy will also be defined for drilling and completion operations and work over operations and normal production on the well pads.

4.1.2 Flowlines

The well-fluids (mixture of gas, crude and water, etc.) from the Kingfisher Field will be sent to the CPF (as described above) via infield flowlines from individual well pads. The flowline inside diameters vary from 6" to 12" depending on detail design. The production flowlines, the water injection flowlines and the water intake flowline will be constructed using carbon steel to ISO 3183 (API 5L).

The flowlines schematic is shown in Figure 29 below.

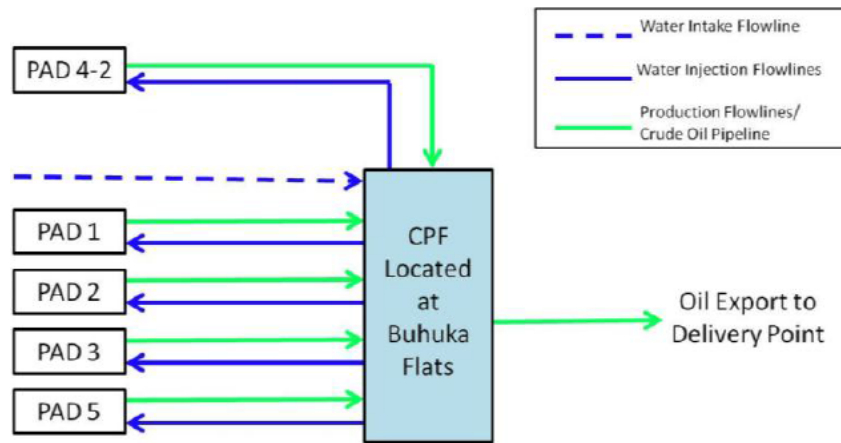

Figure 29: Flowlines schematics.

The flowlines shall be heat traced, possibly with Skin Effect Heat Tracing (SEHT), and insulated for heat conservation. The flow line shall be buried, and the buried depth shall be based on the standard requirements. An impressed current cathodic protection system shall be provided. The flowlines and cables shall be installed in a single trench, with each trench containing:

- Produced well fluids flowline. This shall be buried, trace heated, insulated, and piggable;
- Injection water flowline. This shall be buried, insulated, and piggable;
- Electricity power cable (unless overhead cable transmission is selected);
- Telecommunications FOC (Fibre Optic Cable).

It is envisaged that the power cable and FOC shall be bundled into a single umbilical (with redundancy for both services).

4.1.3 Central Processing Facility

The well-fluids from the Kingfisher field will be sent to a Central Processing Facility (CPF) on the Buhuka flats. The well-fluids will be processed in the CPF to separate formation water and associated gas from the oil phase. The oil will be stabilized, desalted and dehydrated to meet the export specification of oil.

Associated gas will be separated at the CPF and utilized in priority for field requirements such as fuel gas for power generation, heating system and other utilities. The opportunities to utilize any excess associated gas that cannot be utilized within the CPF will be determined by Government of Uganda during the detail design of the CPF including:

- Supply of gas to other third party power producer integrated with all the developments in Lake Albert Area;
- Excess power export to other users; and
- Liquefied Petroleum Gas (LPG), or any other possibilities of gas utilization.

Produced water from separators is required to be treated in three stages of separation to achieve the injection water specifications. Produced water along with treated lake water from the CPF will be injected into the reservoir. Lake water will be pumped to the CPF via a dedicated flow line running from the Lake Albert intake facilities.

The equipment sparing requirements shall be confirmed during the detailed design for CPF.



4.1.3.1 CPF Location

The CPF will be located within the Buhuka Flats at the position as indicated in Figure 24 with the coordinates for the centre of the facility being E249, 819 and N137, 863 with the area of the CPF covering an area of 280,000m². A detailed baseline of the proposed location and factors in the determination of the exact location as well as analysis of alternatives will be undertaken in the ESIA and presented in the ESIS.

4.1.3.2 CPF Capacity

The processing facilities will be designed with the following capacities:

- Oil: 40,000 BOPD (1,991,878 tpa)
- Gas: 10.6 MMSCFD (63,224 tpa)
- Produced water: 110,600 BWPD
- Gross liquids: 120,000 BLPD
- Water Injection: 124,500 BWPD
- Make-up water: 40,000 BWPD

The facilities described here are designed for a stand-alone development of the Kingfisher field, and sized on the data currently available for this field. Actual capacities of the surface production facilities may be in practice different as they will be selected in a context of regional optimization of field developments in the area. Detailed capacity and design shall be included in ESIA.

4.1.3.3 Typical CPF Layout and main components

This section introduces the construction components of a typical CPF. The typical layout of the CPF is indicated in Figure 30.



AIR QUALITY AND GREENHOUSE GAS ASSESSMENT

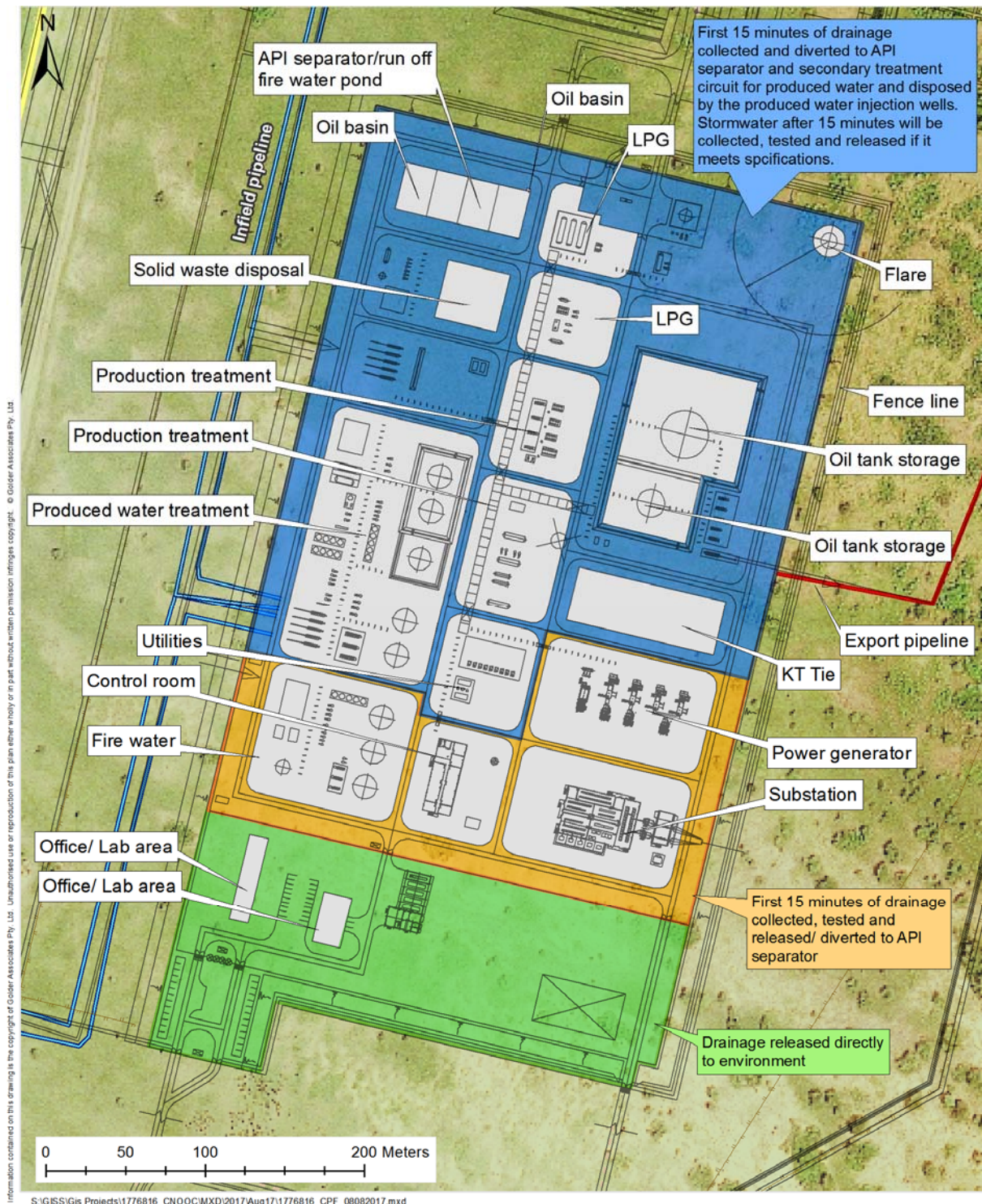

Figure 30: Layout of the Central Processing Facility (CPF) in relation to other facilities





For a typical CPF, it shall include:

- A 2-stage production separation train;
- Associated gas compression;
- Electricity generation;
- Electrical switchgear and distribution equipment; Produced water and lake water treatment and pumping facilities;
- Produced oil and off-spec oil tankage;
- Diesel fuel tankage;
- Transmission pipeline pump station;
- Transmission pipeline pig launcher station;
- Flowline pig receivers station;
- Oil production manifold;
- Water injection manifolds;
- Chemical injection facilities;
- Safety Flare system;
- Open and closed drains systems;
- Station piping and valves;
- An Integrated Control Safety and Shutdown System (ICSS);
- Safety equipment at the plant shall include fire and gas detectors, fire water storage, a fire water ring main and hydrants and monitors, CO₂ system, fire station equipped with fire engine(s) (if required), etc.;
- Plant air system;
- Inert gas system;
- Impressed current CP system;
- Equipment earthing system;
- Field instrumentation, including flow metering;
- An air-conditioned, manned control room;
- Area lighting;
- CCTV;
- Security structures, fencing and barriers;
- Maintenance workshop;
- Office and administrative Facilities; and,
- Laboratory.





4.1.3.4 Electricity Generation and Distribution System

Electricity shall be generated at the Kingfisher CPF. The electricity generation system at CPF shall comprise:

- Generators;
- MV switchgear;
- HV switchgear.

The electricity distribution system shall comprise:

- Transformers and switchgear at CPF to power CPF requirements and the pump station for the CPF-Kabaale oil export pipeline;
- Cables from CPF to each of the well pads, and transformers and switchgear at each well pad;
- A cable from CPF to the Water Extraction Pump Station, and a transformer and switchgear at the pump station;
- A cable from CPF to Kabaale with connections to each intermediate heating station and isolating block valve station along the route of the CPF-Kabaale pipeline. Each connection shall include a local transformer and switchgear;
- A cable from CPF to the Permanent Operators' Accommodation Camp; and
- A transformer, switchgear and distribution system at the Permanent Operators' Accommodation Camp.

4.1.3.5 Water Abstraction and Injection

The water injection requirements cannot be met by produced water reinjection alone; hence an additional source of water is required. A water intake system requirement and optimization study shall be carried out during the detail design. According to the nature condition of Lake Albert, the lake water intake system will be built at the lake edge. The preliminary location is at E249, 658.00 and N138, 950.00.

The water intake system shall comprise: A combined concrete water intake pump-house structure close to the shore line incorporating a pump basin, a silt collection basin and trash screen section and pump-house. The depth of the structure would be set to cover the range of design lake water levels and the pump basin depth set to ensure pump performance at the minimum lake level. Issues and suggested approach include, but are not limited to:

- A water transfer pipeline to transfer water from the intake pump station to the CPF water treatment facilities;
- Chemical injection package at the intake facility;
- Equipment earthing system at pump station;
- Field instrumentation at pump station;
- Area lighting at the pump station;
- CCTV at the pump station;
- Security fencing at the pump station.

Lake water shall be transferred to the CPF where it shall be de-aerated, filtered, chemically treated (if necessary), and mixed with produced water. The mixed water shall be heated and pumped to the well pad cluster sites for injection into the reservoir.

The water abstraction point is located near Pad 2.



4.1.3.6 Instrumentation and Control System

The Kingfisher Field Development instrumentation and control is segregated into onsite requirements, i.e. Central Processing Facility (CPF), pumping station & Kabaale facility and offsite requirements, i.e. Well pads, valve manifold and pigging stations, block valve station, flowlines and crude oil transmission pipeline.

Overall control of the Kingfisher oil production and transmission system shall be from the manned Central Control Room (CCR) at the CPF.

The Kingfisher Field development project shall be equipped with an Integrated Control & Safety System (ICSS) comprising:

- Process Control System (PCS);
- Emergency Shutdown system (ESD);
- Fire and Gas Detection System (FGS);
- Supervisory Control and Data acquisition system (SCADA);
- Human Machine Interface (HMI).

The ICSS equipment and Operator workstations installed in the CCR at the CPF shall enable the operator to monitor and control the SCADA, PCS, ESD and FGS. A subset of ICSS shall also be located in the Kabaale Tie-in to facilitate exchange of monitoring & control signals to CPF CCR.

Operator Work stations (OWS) shall enable monitoring and control of the entire CPF, and associated well pads, flowlines and manifolds. The OWS shall also display ESD system and FGS data and alarms, and provide access to the safety functions of the ESD & FGS.

An Instrument Equipment Room (IER) adjacent to the CCR shall house all the system and marshalling cabinets and some mechanical package Unit Control Panels (UCP), e.g. Compressor UCP. Under normal operating conditions the operator shall monitor and control the packages from the ICSS operator stations in the CCR.

The primary source of process information shall be provided by field instrumentation capable of measuring all physical process parameters. Sufficient instrumentation shall be provided to allow all necessary control and safety functions to be carried out.

The ICSS shall have a seamless integration of all instrument systems to serve plant monitoring, control, safety and operations of the facilities, including those off-sites. As a minimum the following systems shall be interfaced:

- Crude oil Metering at CPF and Kabaale;
- Machine Monitoring System (MMS);
- Pipeline Leak Monitoring System (PLMS);
- Electrical Switchgear/ Motor Control Centre;
- Unit Control Panels (UCPs);
- 3rd Party package Units.

The control and monitoring facilities shall be distributed across a number of different locations:

- RTUs at remote Gathering Facilities (Well pads);
- CCR/ LERs at the CPF;
- RTU at pipeline Block Valve Station;



- RTUs and Heat tracing controllers at Intermediate Power Feed Stations along the Transmission Pipeline;
- RTU at Kabaale.

4.1.4 Export Pipeline

A buried crude oil pipeline about 50km long with a width of approximately 12"~14" (and requiring a servitude of approximately 30m³) with Block Valve Station (BVS) on the escarpment is proposed for the oil export from CPF to the delivery point. The block valve proposed to be installed at the top of the escarpment for the following reasons:

- If the oil pipeline is damaged between the BVS and the CPF there is potential for the whole of the contents of the pipeline to backflow down the escarpment to the leak point. The block valve, which can be remotely operated from the CPF, shall significantly reduce the amount of oil that could emanate from such a leak.
- Given the pressure head created by the escarpment, the pressure rating of the section of the pipeline between CPF and the BVS is significantly higher than the pressure rating of the pipeline downstream of the BVS. The block therefore forms a natural break point between the two pressure ratings.

In addition to the BVS at the top of the escarpment, one further BVS shall be provided with located on the CPF to Kabaale pipeline. The proposed route of the pipeline is shown in Figure 31.

The crude oil pipeline will be insulated with a minimum thickness of PUF insulation (or similar material) and a skin-effect heat tracing system (SEHT) to achieve and maintain flowing temperatures at or above pour point plus 5 degrees Celsius (5°C). The oil export pipeline will be constructed using carbon steel to ISO 3183 (API 5L). This material is suitable for this service of transporting sales quality crude oil.

A power cable running parallel to the crude oil pipeline will provide power to the intermediate heating stations along the crude oil pipeline route. A fibre optic capability will also be provided as part of the SCADA system between the Central Control Room (CCR) in the CPF, the BVS and the delivery point.

Electricity shall be generated at the Kingfisher CPF. A high voltage transmission cable (buried and installed in the same trench as the oil export pipeline) routes from Kingfisher CPF to Kingfisher Block Valve Station and on to Kabaale, with connections to each intermediate heating station and isolating block valve station along the route of the export pipeline. Each connection shall include a local transformer and switchgear.

Pipeline Leak detection System (PLDS) will be provided for crude oil transmission line from CPF to the delivery point, which would be integral component of ICSS.

The SCADA system at the CPF will interface the remote controlled block valve station located along the crude oil pipeline to the delivery point. The SCADA system will also interface with the off-plot heat tracing power feed station controllers to enable the CCR operators to control and monitor the heat tracing temperature.

³ This will be updated for optimization during the FEED design.

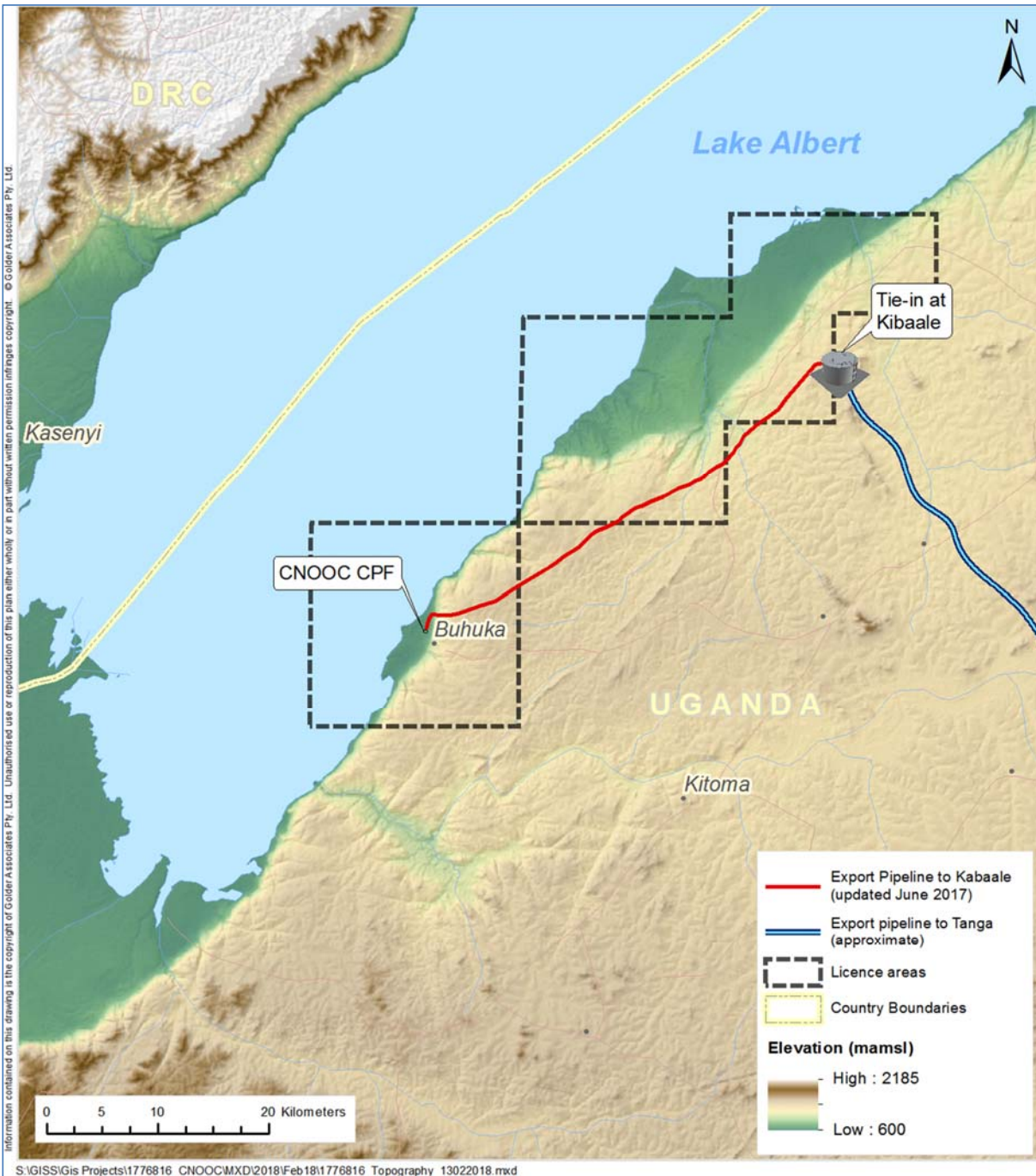

Figure 31: Location of the export pipeline





4.1.5 Supporting Infrastructures

4.1.5.1 Access roads

Escarpment Road - The Escarpment Road is a subject of a separate ESIA process; nonetheless, it is one of the components of the Kingfisher field development project. The proposed Escarpment road will start at the Ikamiro village on the escarpment top and ends around well pad 2 on the flat. From Ikamiro village to the base of the escarpment, there is no road and this is where access to the Kingfisher Area is required.

The total length of the proposed escarpment road is approximately 7 kilometres long and 9 metres wide including shoulders. It is proposed that the road will be of a double base bituminous surface standard. Approximately 150 persons will be employed during the preparation and construction phase to include skilled and semiskilled labour. The supporting facilities of the road will include two construction camps, crusher plant and bitumen storage-area, spoil-areas; borrow pit and water abstraction points.

In field Roads - The proposed infield roads will subsequently provide access to the well pads, drilling and permanent camps and to the CPF. The location of the proposed infield/ access roads is presented in Figure 24. Since the road network is required in place way before the actual field development program to support pre-field development planning activities, a separate ESIA has been undertaken to ensure earlier approval of such important long lead infrastructure.

4.1.5.2 Airstrip

CNOOC has undertaken maintenance civil works on a light aircraft airstrip in Kyabasambu village. The existing airstrip obtained regulatory approval from an EIA prepared for Kingfisher-1 oil exploration well, and was subsequently constructed in 2006. Further upgrade of this airstrip may be considered during the Kingfisher field development. The location of the proposed Airstrip is presented on Figure 24. A detailed description of proposed upgrade activities will be presented in the ESIS.

4.1.5.3 Camps and materials yard

All of the proposed camps and materials yards will be built outside of the lake protection zone, i.e. beyond 200 meters of the lakeshore.

4.1.5.3.1 Camps

Currently, there is an existing Bugoma drilling camp in Kingfisher that accommodates the crews undertaking field planning and rehabilitation of some field infrastructure ahead of the anticipated field development program. Kingfisher field construction and the production phase will however necessitate a number of various crews that will undertake among other activities, the construction and upgrade of the necessary infrastructure (pipeline, CPF, well sites among others), drilling, production and processing, management of crude export along the pipeline and other support service contractors. These activities are intensive and necessitate resident specialized crews to be accommodated in proximity to their work stations. Since however, the temporal occupation of the various crews is not uniform and only dependent on the lifespan of the particular project component, there is a consideration to have more than one camp for the project to include:

- a) The drilling crew camp (drilling camp) – which is the existent current Bugoma camp located on a footprint measuring about 7 acres (185m x 185m) in Kyabasambu Village. The camp can accommodate a maximum of about 250 people.

The permanent operators' accommodation Camp (production camp) - this will be similar to the drilling camp however with more permanent facilities. Based on initial estimates the camp would be sized for around 220 personnel (approximately 200m x 150m) and would include operational, maintenance, support, security and Well Work over personnel. The drilling crew workforce is not included as a separate camp will be provided as mentioned;

- b) Two temporary construction camps will be required: One is dedicated to the CPF and in-field facilities. The site area is approximately 520m x 500m. The other is associated with the crude oil pipeline construction. The site area is approximately 250m x 150m. The estimate for the area size is preliminary and shall be final determined during detail design.





- The CPF and In-field Construction camp would be located on the Buhuka flats north of the CPF. The camp will comprise accommodation, messing and welfare facilities for the labour force undertaking the construction and commissioning work. An initial camp will be provided at the commencement of the project for the site enabling and early works, but would then be extended as the project progresses and the workforce increases.
- Another construction camp dedicated to the construction of the export pipeline from Kingfisher CPF to Kabaale would be provided. This construction camp would be significantly smaller than the main Kingfisher Construction camp. The exact location of the camp would be determined at a later stage of the project and would be dependent upon the selected construction sequence. Due to the relative short length of pipeline, a single accommodation and welfare facilities for the pipeline construction team would be provided, ideally around the mid-way point of the route. The pipeline accommodation camp would be fully self-sufficient comprising power generation, water treatment and sewage and waste disposal.

A typical camp shall have:

- Air-conditioned housing of varying grades with ablution facilities;
- Refectory messing facility (with food and drink storage facilities);
- Laundry facilities;
- Sick bay and first aid medical facility;
- Recreational & sports facilities (indoors and outdoors);
- Communications facilities;
- Area flood lighting;
- Camp office warehouse and maintenance facility;
- Electrical transformer, switchgear, and distribution system;
- Stand-by emergency diesel powered electrical generation;
- Potable water production and storage facilities;
- Sewage water treatment plant;
- Security gatehouses and fencing;
- Internal access roads, footpaths and parking areas.
- Fuel Station
- Vehicle maintenance house and washing bay
- Fire fight station, fire detection and fire-fighting system
- Waste storage and packing area
- Emergency Alarm system and PA system
- Smoking Area
- Training room
- POB and Accommodation management System and access control system.

A typical layout of workers' camp is shown below:



Figure 32: Layout for a typical workers' camp.

Another proposed consideration is to uphold and upgrade the camp used for the escarpment road construction at the escarpment top in Ikamiro village. The motivation for this proposal is because of its strategic position to effectively purpose as:

- i) A security watch tower – the proposed camp on the escarpment is about 388m above the Kingfisher production field (Buhuka flats) giving a strategic watch height for the entire Kingfisher production area and beyond into the lake. This is important for security management especially that the production fields are on the shores of a cross border lake thus vulnerable to external intrusion.
- ii) Evacuation base – In case of an evacuation emergency of security or catastrophic nature, this camp could provide a safe haven for the operating crews in the flat by virtue of its elevation above the flats. Evacuation would be easier especially that the camp will be connected to the flats by a paved escarpment road.
- iii) VIP stopover – The camp would also act as a stopover for very important people visiting the kingfisher field to enable security and safety reassurance down in the production area.

A typical and proposed camp location and layout is presented in Figure 24 and Figure 32 respectively and will be confirmed during the ESIA. A more detailed assessment of the proposed camp sites will be undertaken during the ESIA.

4.1.5.3.2 Materials yards

Two material yards are proposed to be constructed in Kingfisher to separately accommodate the drilling and construction equipment and material supplies respectively.

One of the proposed materials yard to be located near to the northern edge of Bugoma Camp is intended to provide logistical support to operations of the proposed drilling operations. Another similar materials yard will



AIR QUALITY AND GREENHOUSE GAS ASSESSMENT

be located near the CPF for production and EPC contractor camp. The yard will have a land requirement of approximately 200x200 meters, all levelled and compacted with murrum. A detailed description of the components at the yard will be presented in the ESIS.

Construction of the storage yards will entail stripping away of the overburden, placing murrum and compacting to create a firm flat surface suitable for supporting heavy equipment. The overburden will be stockpiled for future use during site restoration.

The layout for a typical materials yard is shown in Figure 33 below:

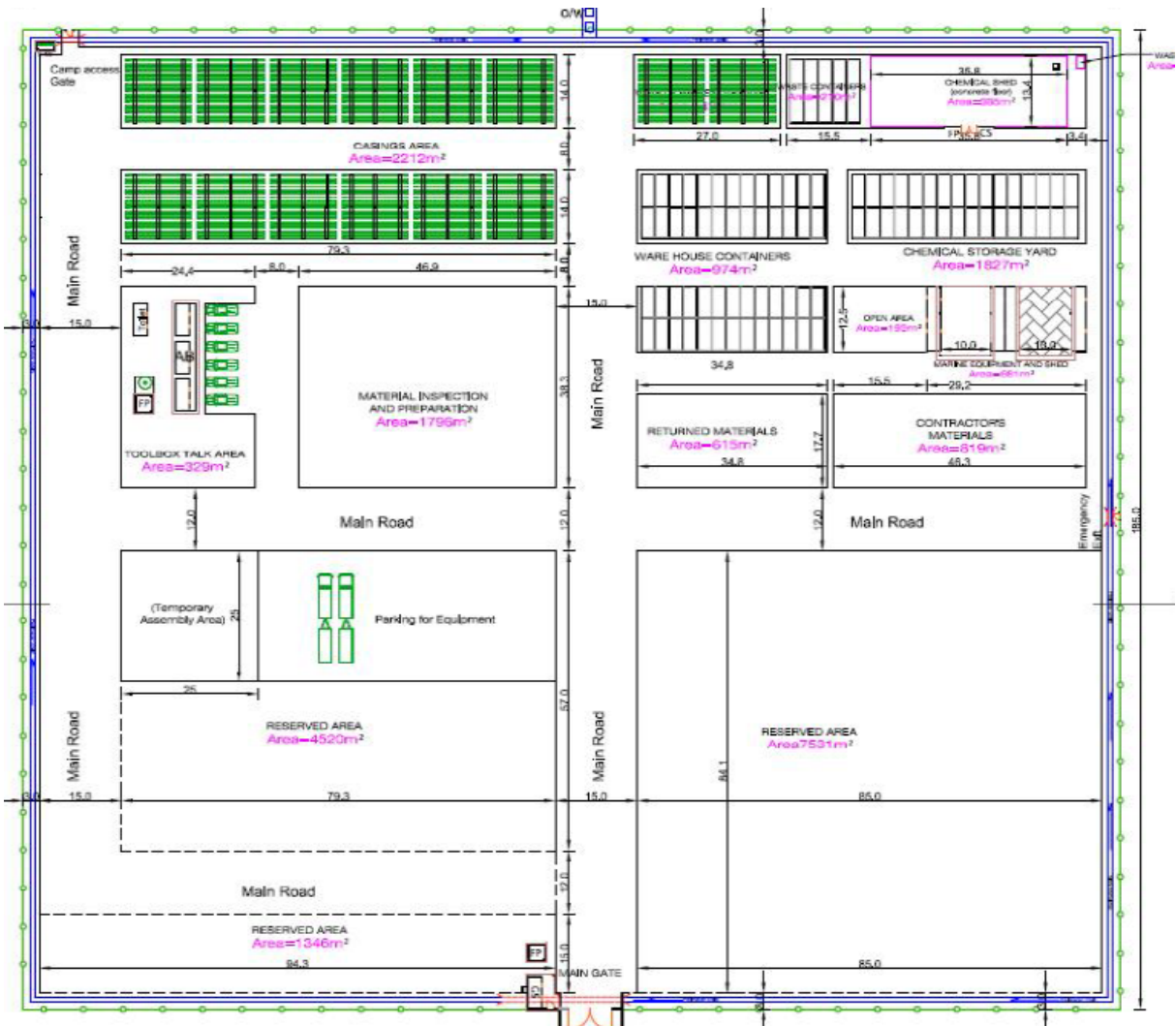

Figure 33: Layout for a typical materials yard.

The location of the material yards are also shown in Figure 24.

4.1.5.4 Jetty

CNOOC has rehabilitated (rehabilitation was permitted separately under a project brief) the existing jetty adjacent to Bugoma drilling camp in Kyabasambu village to facilitate the movement of personnel, materials and equipment during the Kingfisher field development project. The jetty was constructed in 2006 by Heritage Oil &



Gas (Uganda) Limited to facilitate Kingfisher-1 exploration well drilling operations. Since that time, no maintenance works had been undertaken on the jetty thus was dilapidated. Further upgrade that may be considered during the kingfisher field development will be described in the ESIS.

4.1.6 Proposed construction activities

All infrastructural developments listed above will entail construction activities that shall include in general:

- a) Ground clearance and levelling of the specified sites
- b) Excavation and laying of the foundations to host the installations
- c) Installation of pertinent infrastructural components particular to the respective facility.
- d) Linking of support infrastructure (access roads, water and power lines) to the respective facility.

Normally in the construction phase, bulldozers, excavators, dump trucks, vibrating roller, crane and other equipment and machines will be used. Construction materials including murrum, sand, cement, steel and wooden post among others might be sourced outside of Kingfisher field.

Specific in-depth description and assessment of construction activities, number of equipment and personnel, and quantity of construction materials will be undertaken for the particular construction activities of the facilities in the ESIA.

4.1.7 Overview of the implementation phases of the project

This project will mainly involve three phases: Preparation phase, Construction phase, and Operation phase. During the preparation phase: a range of geophysical survey, planning and designing work will be done. During the construction phase, a range of well pads, wells, pipelines, central processing facilities, camps, airstrip, road, jetty, and other infrastructural support facilities will be constructed.

It should be noted that drilling operations of development wells shall continue after the onset of the first oil production. Therefore the construction phase and operation phase will overlap (Figure 34).



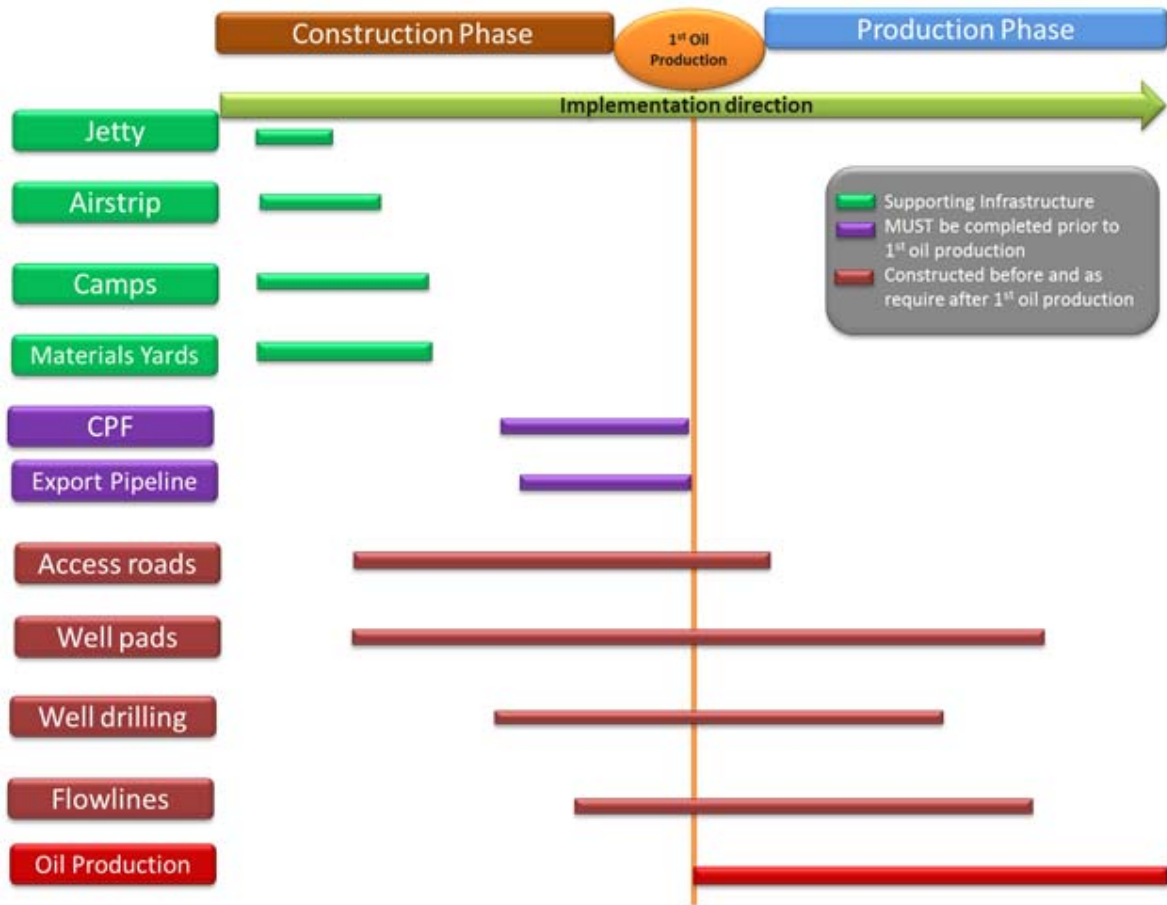

Figure 34: Project implementation.





4.1.8 Kingfisher Operations Overview

4.1.8.1 Overview of the process flow at the CPF

Well fluids from individual wells will be pumped using Electrical Submersible Pumps (ESPs) for artificial lift in order to meet the required flowing wellhead pressure and is collected in the production or the test manifolds.

To enable testing and metering of well fluids from individual wells, the well-fluids from a production well shall be diverted to the Test Manifold and then through a multi-phase flow meter before combining with the flow from the production manifolds.

Well fluids from the production and test manifolds are metered in multi-phase flow meters and sent to the CPF via flow lines. The flow lines will be heat traced, buried and insulated. SEHT in the flowlines ensures that the temperature in the flow lines does not fall below pour point temperature of maximum $45^{\circ}\text{C} + 5^{\circ}\text{C}$ design margin under normal flowing conditions. SEHT design will however ensure the possibility to operate at $\text{WAT} + 5^{\circ}\text{C}$, in case of operational issues with operation at pour point $+ 5^{\circ}\text{C}$. SEHT design is also suitable to provide heating of the flow lines during start-up to 80°C in 24 hours to melt the entire wax. The flow lines are provided with pig launching/receiving facilities to enable the periodic pigging of the production flow lines.

Each well pad also consists of reception facility for the injection water flow line from the CPF to water injection wells. The flow lines from CPF terminate in a Water Injection Manifold. Connections are provided from the manifold to individual water injection wells. Stub connection has been provided for the future connection to a water disposal well, if the produced water quantity exceeds the water injection quantity. This connection is not required for the project. Connections are provided on the water injection flow lines for the installation of temporary pig launcher/receivers if it is desired to carry out pigging of these flow lines.

The chemical injection requirement will be confirmed by means of tests and based on crude oil production chemistry. Presently, defoamer, scale inhibitor and corrosion inhibitor injection have been considered in the production manifolds and test manifolds. Demulsifier is injected directly downhole via a downhole injection string at the ESP suction to destabilise emulsions. The chemical injection facilities are local to each well pad and requisite chemical storage and filling facilities will be available at the well pad.

In order to handle the oily drains from pipelines and equipment, each well pad is also provided with an underground closed drain drum and submersible pump. The drain drum level will be monitored and the drum should be periodically emptied into a mobile tanker.

It is anticipated that the wells will produce sand and sand screens will therefore be installed in the well. However, the ESPs will lift some sand to the surface. Therefore, the downstream equipment at CPF will be installed with on-line sand removal and disposal facilities.

4.1.8.2 Liquid-liquid separation and oil stabilisation

The flow lines from individual well pads will terminate into a common inlet manifold that supplies the well fluids to the 1st stage separator. The 1st stage separator is a three phase separator operating at 8.0 barg.

The 1st stage separator separates the vapour, oil and water from the well fluid to ensure that the water content in the oil phase from the separator has a maximum of 25% water-cut. Vapour from the separator will be sent on pressure control to mix with the flash gas compressor discharge. The separated produced water will be sent to the produced water treatment unit.

The separated oil-water mixture from the 1st stage separator will be sent on level control to 2nd stage feed/Oil Exchanger where it will be heated regenerative with stabilized crude, and 2nd stage separator feed heater where it is heated by heating medium.

The crude-water mixture is heated up to 95°C in the above two exchangers and sent to the 2nd stage separator. The 2nd stage separator is a 3 phase separator operating at about 0.5 bars and 95°C to stabilise the crude sufficiently for storage and export. Oil from the 2nd stage separator is pumped to the electrostatic separator on level control. Water from the 2nd Stage Separator is pumped on level control to the produced water treatment unit. Flash gas from 2nd stage separator is sent to the flash gas compressor inlet cooler.





All the three separators will be fitted with sand removal facilities that include water jetting de-sanding nozzles. Depending on the extent of sand, the sand jetting is required to be either continuous or periodic.

The electrostatic separator is a liquid filled vessel operating at 95°C and provided with electrostatic terminals. The purpose of the electrostatic separator is to achieve the crude oil specification of BS&W content of less than 0.5vol% and salt content of 25ptb. The stabilised crude from the electrostatic separator is cooled by 2nd stage separator feed in the 2nd stage separator feed/Oil exchanger and then by air in the oil cooler to 68°C to remain above the pour point and wax appearance temperature. On-spec stabilised crude is sent to the on-spec storage tank. If the crude oil specifications of RVP and BS&W are not met (recorded by analysers), the crude will be automatically diverted to the off-spec crude tank.

The Process schematic of CPF is presented in Figure 35, the crude oil process is presented Figure 36.

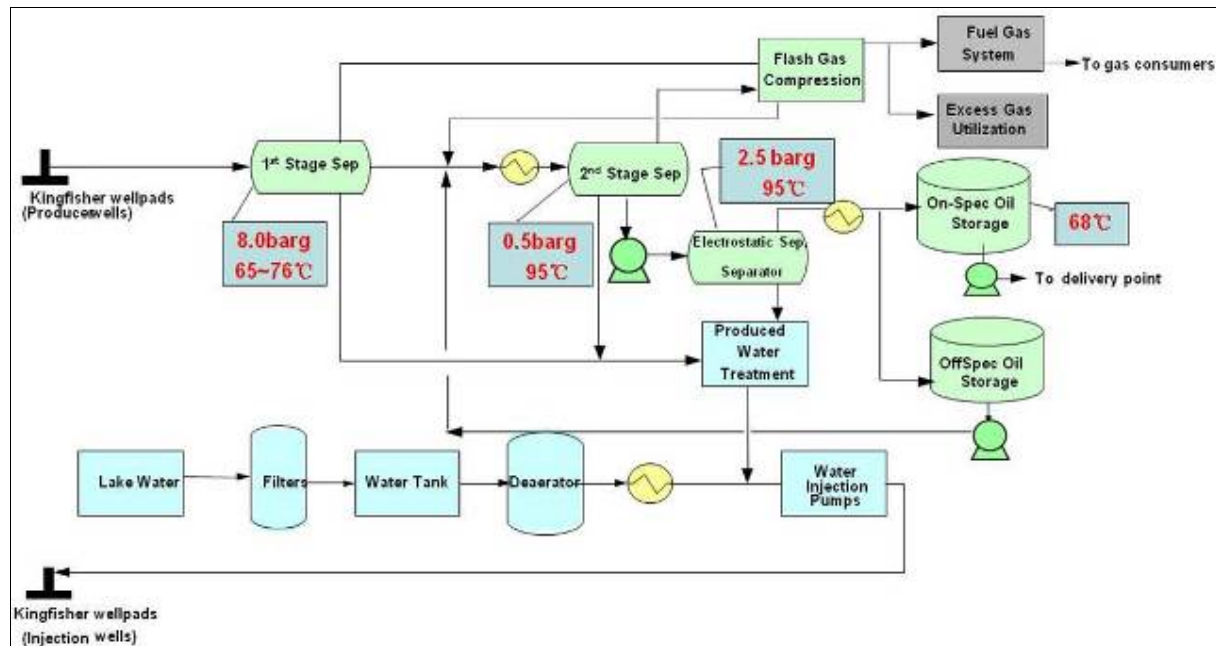

Figure 35: Typical process flow diagram of the CPF (only for illustration purpose).

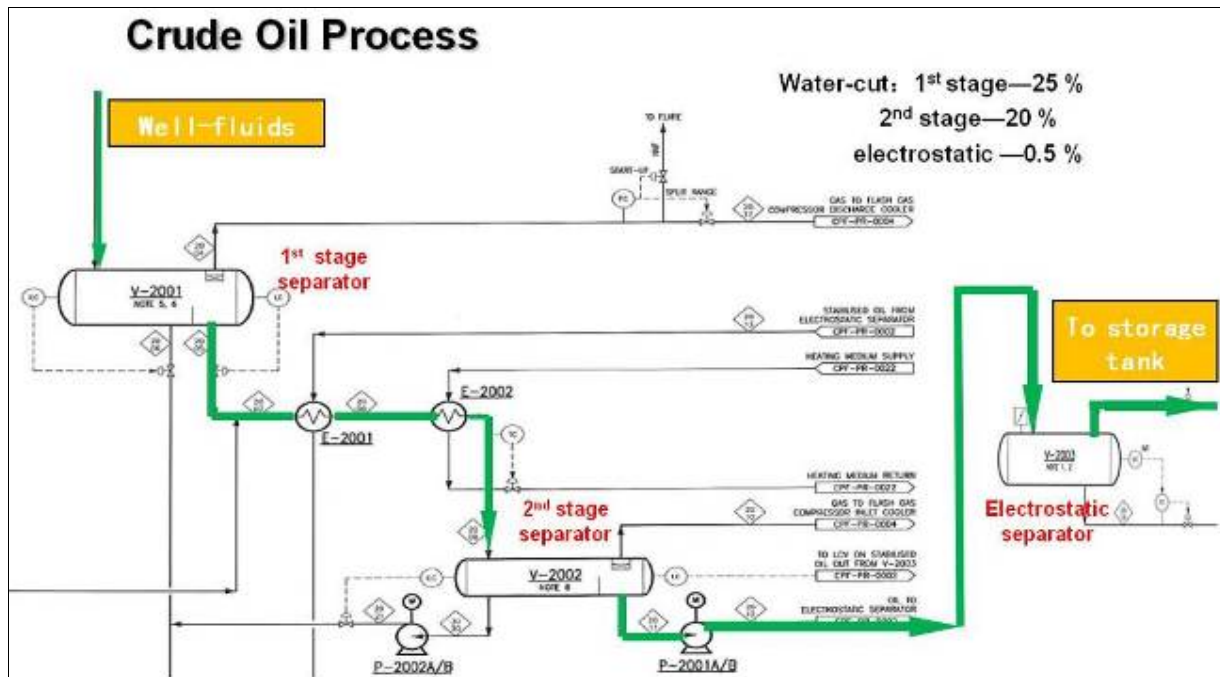

Figure 36: Typical crude oil process (only for illustration purpose).

4.1.8.3 Flash gas compression

Flash gas compressor is single stage reciprocating compressor. Flash gas from the 2nd stage separator is cooled in flash gas compressor inlet cooler and is sent to the flash gas compressor suction drum where the condensate is knocked out and vapour is sent to the flash gas compressor. Flash gas from the 1st stage separator is mixed with the flash gas compressor discharge, upstream of the flash gas compressor discharge cooler. Recycle condensate from the fuel gas compression system also joins the flash gas compressor discharge and is fed to the Flash Gas Compressor Discharge Cooler where it is cooled to 60°C and is sent to the flash gas compressor discharge drum to separate any condensate. If the temperature of the total gas/condensate upstream of the flash gas compressor discharge cooler is <60°C, there is a provision to bypass the air-cooler and send the stream directly to the flash gas compressor discharge drum. Condensate collected in the flash gas compressor discharge drum is sent on level control to the flash gas compressor suction drum. Compressed gas from the flash gas compressor discharge drum is sent to:

- The LP fuel gas super heater to meet the superheat requirements of 30°C before sending LP fuel gas to consumers,
- The fuel gas compression system where the gas is compressed to 36 bars for use in the power generation gas turbines.
- Remaining gas, if any, is sent to the excess gas utilization package.
- Condensate collected in the flash gas compressor suction drum is pumped under level control and reprocessed along with the 2nd stage separator feed. There is a provision to divert the flash gas condensate to the Heating Medium Fired Heaters as a back-up to fuel gas.

The flash gas compression is presented in Figure 37.

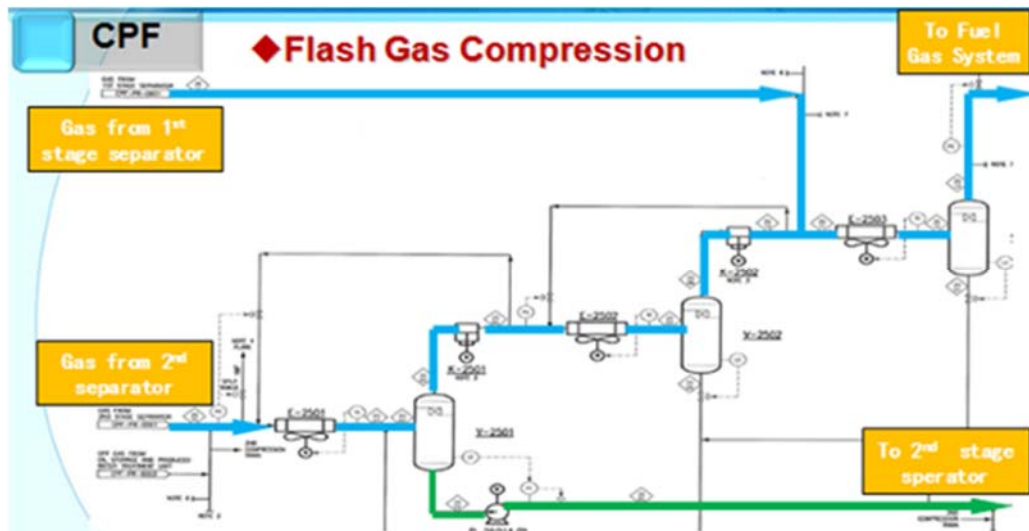

Figure 37: Flow chart of flash gas compression (only for illustration purpose).

4.1.8.4 Oil storage and export

Stabilised oil from the oil cooler will be analysed by online analysers for RVP and BS&W. On-spec crude oil is stored in the floating-roof on-spec oil storage tanks. If the crude oil is off-spec owing to high RVP or BS&W it can be diverted automatically to the off-spec storage. Heat loss from the tanks to the ambient surroundings will be recuperated by means of heating medium coils inside the tanks. The temperature in the tank will be maintained at 68oC by using internal heating medium coils.

On-spec crude oil will be pumped by two pumps in series. Crude oil will be metered in the fiscal metering package that is located on booster pump discharge. The crude from the booster pumps provides sufficient NPSH at the suction of the crude oil transmission pumps. The stabilized crude is pumped by means of crude oil transmission pumps on flow control to Kabaale via the crude export pipeline.

SEHT is provided on the crude oil export pipeline to maintain the temperature above pour point + 5°C. Although the normal operating philosophy is to operate at pour point + 5°C, SEHT design will be suitable to operate at WAT + 5°C, if there are operational issues with operation at lower temperatures.

Off-spec oil storage tank is a conical roof tank with fuel gas blanketing and a vapour recovery system to compress the off-gas from tank using Off-spec Oil storage tank blower. The compressed off-gas is sent to the 1st stage flash gas compressor suction drum to be compressed and used as fuel gas. Off-spec crude oil is recycled to the 2nd stage separator on flow control with tank low level override. Nitrogen will be required as backup for tank pressure maintenance during start-ups. Heat loss from the tanks to the ambient surroundings will be recuperated by means of heating medium coils inside the tanks. The temperature in the tank will be maintained at 68°C by using internal heating medium coils. The crude oil storage and export is presented in Figure 38.

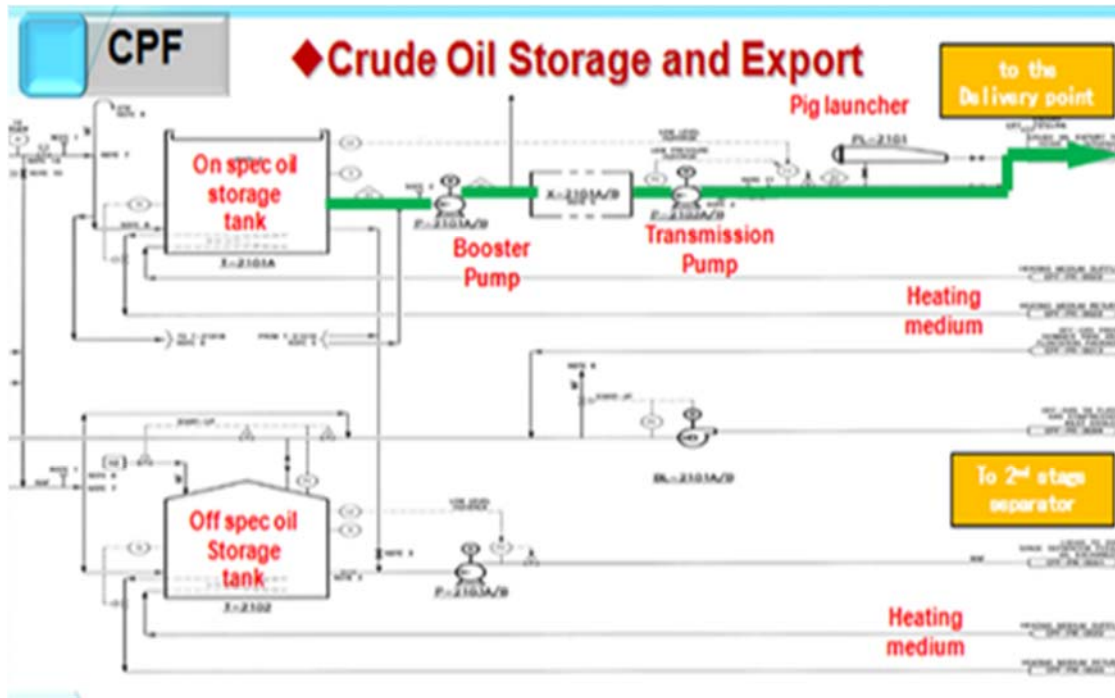

Figure 38: Flow chart of crude oil storage and export (only for illustration purpose).





4.2 Air Emission Inventory

The main sources of air emissions (continuous or no continuous) resulting from oil and gas development activities include:

- Combustion sources from power and heat generation, and the use of compressors, pumps, and reciprocating engines (boilers, turbines, and other engines);
- Emissions resulting from flaring and venting of hydrocarbons; and,
- Fugitive emissions.

Principal pollutants from these sources typically include nitrogen oxides (NO_x), sulphur oxides (SO_x), carbon monoxide (CO), and particulates (TSP, PM₁₀, PM_{2.5} and dust fallout). Additional pollutants can include: hydrogen sulphide (H₂S); volatile organic compounds (VOC's); methane and ethane; benzene, ethylbenzene, toluene, and xylenes (BTEX); glycols; and polycyclic aromatic hydrocarbons (PAHs) (IFC, 2007).

The following scenarios were considered:

- Construction,
- Operation including abnormal conditions (start-up, upset conditions and shutdown); and,
- Decommissioning.

The emission inventory is based on the following inputs:

- Construction and operations will overlap;
- Production of:
 - Oil at 40 000 BPD (1 991 878 tpa); and,
 - Gas at 229 scf/bbl (72 887 tpa).
- Natural gas produced will be consumed in combustion processes;
 - 56% will be used for power generation (16 MW output), the remainder (44%) flared; and
 - The natural gas contains no sulphur (Table 12);
- Diesel fuel sulphur content is 500 ppm;
- Engine:
 - Thermal efficiencies are 30%; and,
 - Fuel air ratios 1:10.



Table 12: Composition of the natural gas.

Compound	Mole %
C1	73.85%
C3	11.65%
C2	5.94%
nC4	3.79%
nC5	1.41%
iC5	1.31%
iC4	1.28%
H2O	0.27%
CO2	0.22%
C6	0.17%
M Cyclo C5	0.04%
N2	0.03%
Cyclo C6	0.02%
C7	0.01%
Other	0.01%
Total	100.00%
Notes:	
<ul style="list-style-type: none"> • The natural gas produced does not contain sulphurous; or, • BTEX compounds (benzene, ethylbenzene, toluene, and xylenes). 	

Emissions from engines were calculated using US-EPA and / or EA-NPI uncontrolled emission factors or worst case scenario factors, significant reductions in both NO_x and CO emissions (75% to 95%) can be achieved with post-combustion control technologies. Post-combustion control technologies applicable to these sources include selective catalytic reduction (SCR), non-selective catalytic reduction (NSCR), and catalytic oxidation (CO oxidation catalyst). (US-EPA, 2000).

Table 13: Physical parameters for emission sources.

Description	Height (m)	Diameter (m)	Exit (m/s)	Velocity	Exit (K)	Temperature
Well Pad 1	4	0.5	50.0		423	
Well Pad 2	4	0.5	50.0		423	
Well Pad 3	4	0.5	50.0		423	
Well Pad 4A	4	0.5	50.0		423	
CPF Fugitive	2	1.0	1.0		373	
CPF Vent	14	5.0	0.0		373	
CPF Flare	28	9.0	0.5		623	
CPF Generators	17	3.0	5.5		623	
CPF Heaters	17	2.4	0.0		623	





Table 14: Locations of emission sources.

Senior review: Lance Coetzee	Senior review: Lance Coetzee	Senior review: Lance Coetzee	Senior review: Lance Coetzee
Well Pad 1	248581	137907	624
Well Pad 2	249548	138818	631
Well Pad 3	247512	136116	626
Well Pad 4A	250265	139737	638
CPF Fugitive	249899	137929	636
CPF Vent	249877	137887	635
CPF Flare	249988	138052	636
CPF Generators	249875	137758	643
CPF Heaters	249851	137764	642

4.2.1 Construction

Table 15: Emissions from drilling (6000kW power pack).

Substance	tpa	g/s	mg/Nm ³	mg/Nm ³
Total VOC	4	0.128	20	13
CO	35	1.113	176	113
NO _x	83	2.633	415	268
PM ₁₀	4	0.142	22	14
PM _{2.5}	4	0.139	22	14
SO ₂	3	0.082	13	8
<i>Notes:</i> <ul style="list-style-type: none"> The emissions are based on emission factors for stationary large (greater than 450 kW) diesel engines (EA-NPI, 2008); Uncontrolled NO_x emissions will not meet IFC guidelines (200 mg/Nm³), the application of control technologies will however (reduction of 75-95%) meet this requirement; and, The Sulphur content of the diesel was assumed to be 500 ppm. 				

Construction emissions are associated with land clearing and construction, plus drilling on the well pads. Emissions from land clearing and construction activities will be transient. Drilling will only occur on one well pad at a time (Table 15).

4.2.2 Operation

Emissions for operations are provided in Table 16, Table 17. Drilling will only be undertaken on one well pad at a time, VOC's combustion emissions were assumed not to contain BTEX compounds (benzene, ethylbenzene, toluene, and xylenes), see Table 12 for the composition of the natural gas.





AIR QUALITY AND GREENHOUSE GAS ASSESSMENT

Table 16: Emissions from drilling (6000kW power pack).

Substance	tpa	g/s	mg/Nm ³	mg/m ³
Total VOC	4	0.128	20	13
CO	35	1.113	176	113
NO _x	83	2.633	415	268
PM ₁₀	4	0.142	22	14
PM _{2.5}	4	0.139	22	14
SO ₂	3	0.082	13	8

Notes:

- The emissions are based on emission factors for stationary large (greater than 450 kW) diesel engines (EA-NPI, 2008);
- Uncontrolled NO_x emissions will not meet IFC guidelines (200 mg/Nm³), the application of control technologies will however (reduction of 75-95%) meet this requirement; and,
- The Sulphur content of the diesel was assumed to be 500 ppm.

Table 17: Emissions from power generation.

Substance	tpa	g/s	mg/Nm ³	mg/m ³
Total VOC	3	0.095	6	2
CO	117	3.699	218	96
NO _x	456	14.458	853	374
PM ₁₀	3	0.086	5	2
PM _{2.5}	3	0.086	5	2
SO ₂	0	N/A	N/A	N/A

Notes:

- Results based on emission factors for uncontrolled gas turbines natural gas engines (EA-NPI, 2008); and,
- Uncontrolled NO_x emissions will not meet IFC guidelines (200 mg/Nm³), the application of control technologies will however (reduction of 75-95%) meet this requirement.

Table 18: Emissions from flaring.

Substance	tpa	g/s	mg/Nm ³	mg/m ³
Total VOC	413.2	13.102	773	339
CO	239.6	7.599	449	197
NO _x	41.3	1.310	77	34
PM _{2.5}	6.9	0.218	13	6
PM ₁₀	6.9	0.218	13	6

Notes:

- Results based on emission factors for flaring (EA-NPI, 2013); and,
- Uncontrolled NO_x emissions will not meet IFC guidelines (200 mg/Nm³), the application of control technologies will however (reduction of 75-95%) meet this requirement.



Table 19: Fugitive emissions from oil handling and storage.

Substance	tpa	g/s
Benzene	2	0.076
Ethylbenzene	0	0.008
n-Hexane	3	0.111
Methane	0	0.000
Toluene	2	0.050
Total VOC	14	0.442
Xylenes	2	0.055

Notes:
Results based on emission factors for oil and gas extraction and production (EA-NPI, 2013)

4.2.2.1 Abnormal Operations

Emissions associated with abnormal operations will be transient, these operations include:

- Start-up;
- Upset conditions;
- Venting; and,
- Shut-down.

4.2.3 Decommissioning

Atmospheric emissions from the project will stop at closure; therefore no adverse residual⁴ air quality impacts are anticipated.

⁴ Residual impacts are significant project-related impacts that might remain after on-site mitigation measures (avoidance, management controls, abatement, restoration, etc.) have been implemented.





4.3 Simulations Inputs

4.3.1 Modelling Domain

Dispersion of pollutants were modelled 1.5 m above ground level using on two Cartesian receptor grids with the following attributes:

Table 20: Receptor grids.

Maps	Site Domain	Site Grid
UTM Zone	36 N	36 N
Centre x (m)	248799	248799
Centre y (m)	137215	137215
Radius (km)	20	N/A
Length x (km)	40	6
Length y (km)	40	9
SW x (m)	228799	245799
SW y (m)	117215	132715
NE x (m)	268799	251799
NE y (m)	157215	141715
Resolution (m)	1000	100

4.3.2 Topography

The topography used for the modelled area was obtained from Shuttle Radar Topography Mission (SRTM) data sets. SRTM data sets result from a collaborative effort by the National Aeronautics and Space Administration (NASA) and the National Geospatial-Intelligence Agency (NGA – previously known as the National Imagery and Mapping Agency, or NIMA), as well as the participation of the German and Italian space agencies, to generate a near-global digital elevation model (DEM) of the Earth using radar interferometry.

4.3.3 Meteorology

Accurate dispersion simulations require meteorological data representative of the modelling domain. Data for the period January 2011 to December 2016 was acquired from the Pennsylvania State University / National Centre for Atmospheric Research PSU/NCAR meso-scale model (known as MM5). The MM5 model is a limited-area, non-hydrostatic, terrain-following sigma-coordinate model designed to simulate or predict meso-scale atmospheric circulation.





4.4 Modelling Results

The following scenarios were simulated:

- Construction, and
- Operations.

Only results where maximum concentration approached 25% of the IFC guidelines are presented these include:

- Construction:
 - Drilling on well pad 1, NO₂ maximum hourly concentration (99th percentile) Figure 39;
 - Drilling on well pad 2, NO₂ maximum hourly concentration (99th percentile) Figure 40;
 - Drilling on well pad 3, NO₂ maximum hourly concentration (99th percentile) (Figure 41);
 - Drilling on well pad 4, NO₂ maximum hourly concentration (99th percentile) (Figure 42);
 - Drilling on well pad 1, NO₂ maximum annual concentration (Figure 43);
 - Drilling on well pad 2, NO₂ maximum annual concentration (Figure 44);
 - Drilling on well pad 3, NO₂ maximum annual concentration (Figure 45); and,
 - Drilling on well pad 4, NO₂ maximum annual concentration (Figure 46).
- Operations:
 - Drilling on well pad 1, NO₂ maximum hourly concentration (99th percentile) (Figure 47);
 - Drilling on well pad 2, NO₂ maximum hourly concentration (99th percentile) (Figure 48);
 - Drilling on well pad 3, NO₂ maximum hourly concentration (99th percentile) (Figure 49);
 - Drilling on well pad 4, NO₂ maximum hourly concentration (99th percentile) (Figure 50);
 - Drilling on well pad 1, NO₂ maximum annual concentration (Figure 51);
 - Drilling on well pad 2, NO₂ maximum annual concentration (Figure 52);
 - Drilling on well pad 3, NO₂ maximum annual concentration (Figure 53); and,
 - Drilling on well pad 4, NO₂ maximum annual concentration (Figure 54).





AIR QUALITY AND GREENHOUSE GAS ASSESSMENT

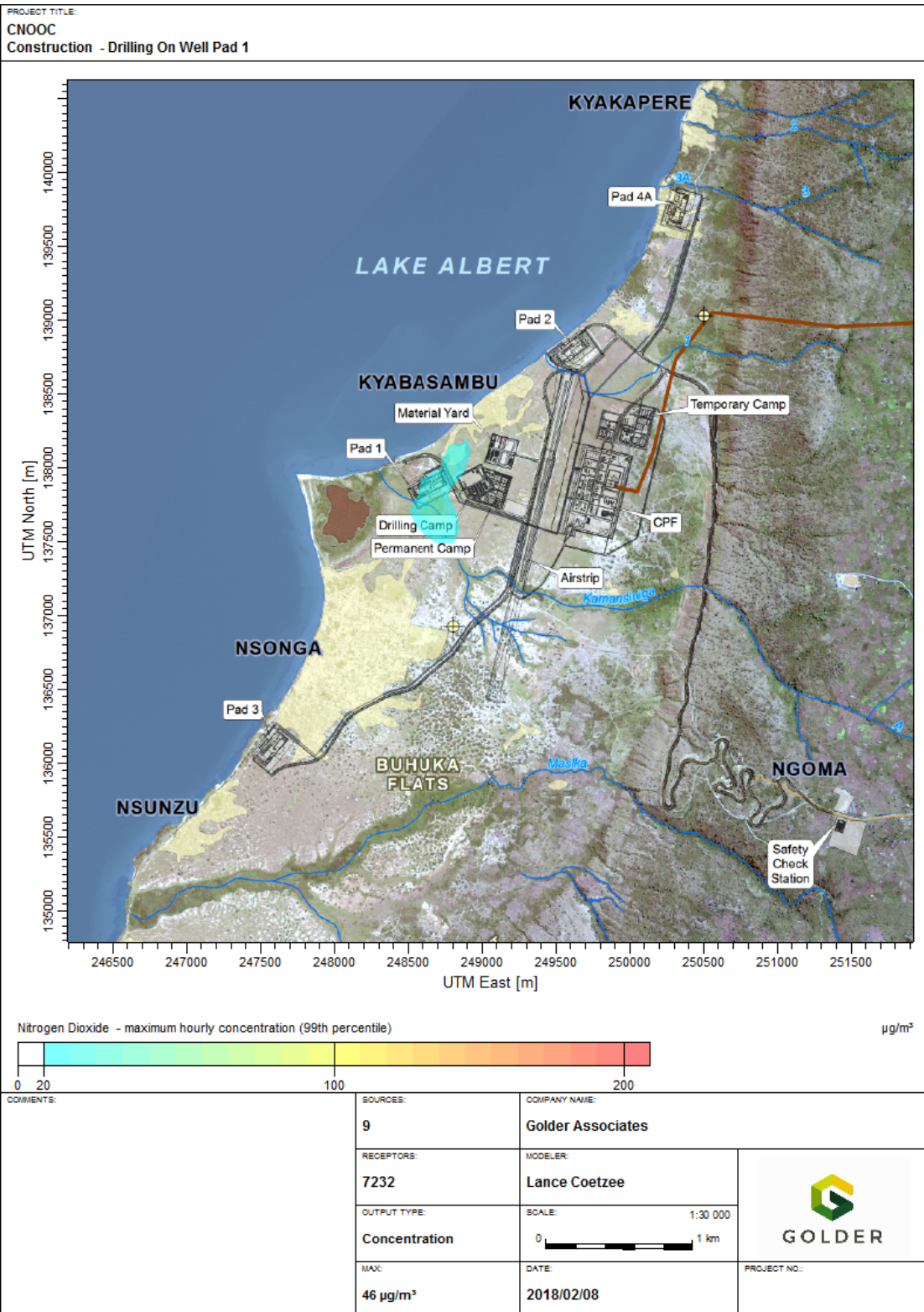

Figure 39: Construction - drilling on well pad 1, NO₂ maximum hourly concentration (99th percentile).





AIR QUALITY AND GREENHOUSE GAS ASSESSMENT

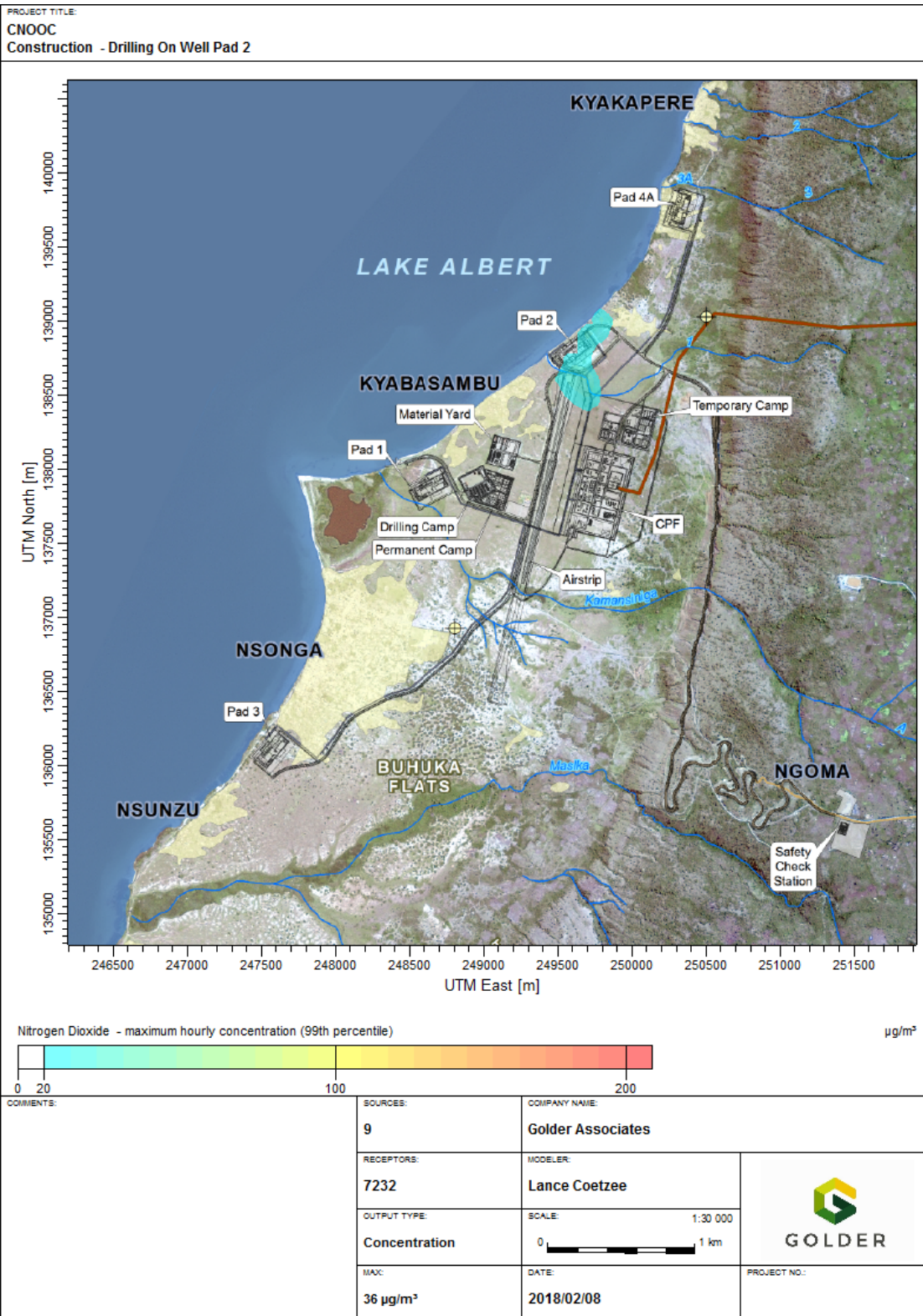

Figure 40: Construction - drilling on well pad 2, NO_2 maximum hourly concentration (99th percentile).





AIR QUALITY AND GREENHOUSE GAS ASSESSMENT

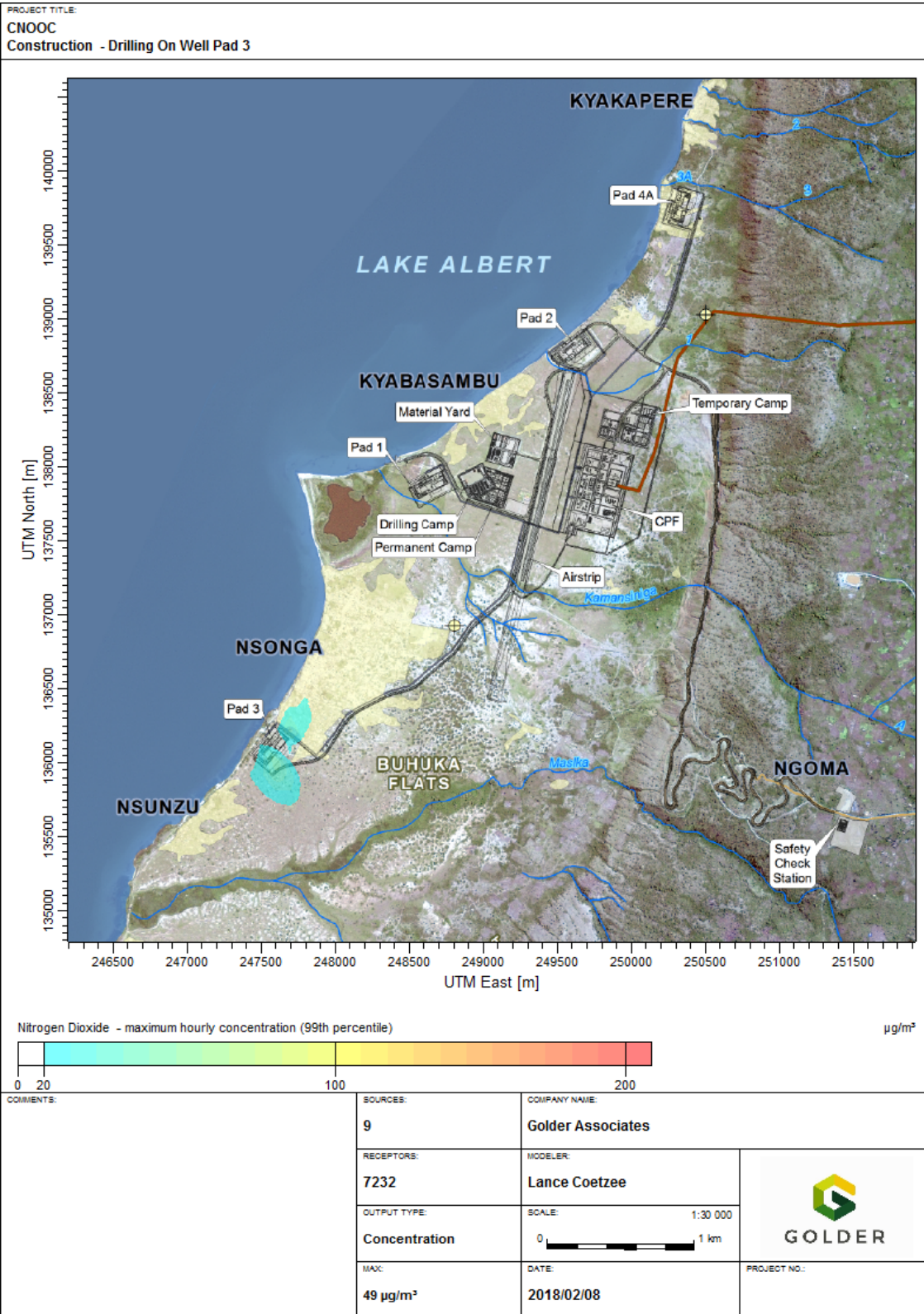

Figure 41: Construction - drilling on well pad 3, NO₂ maximum hourly concentration (99th percentile).





AIR QUALITY AND GREENHOUSE GAS ASSESSMENT

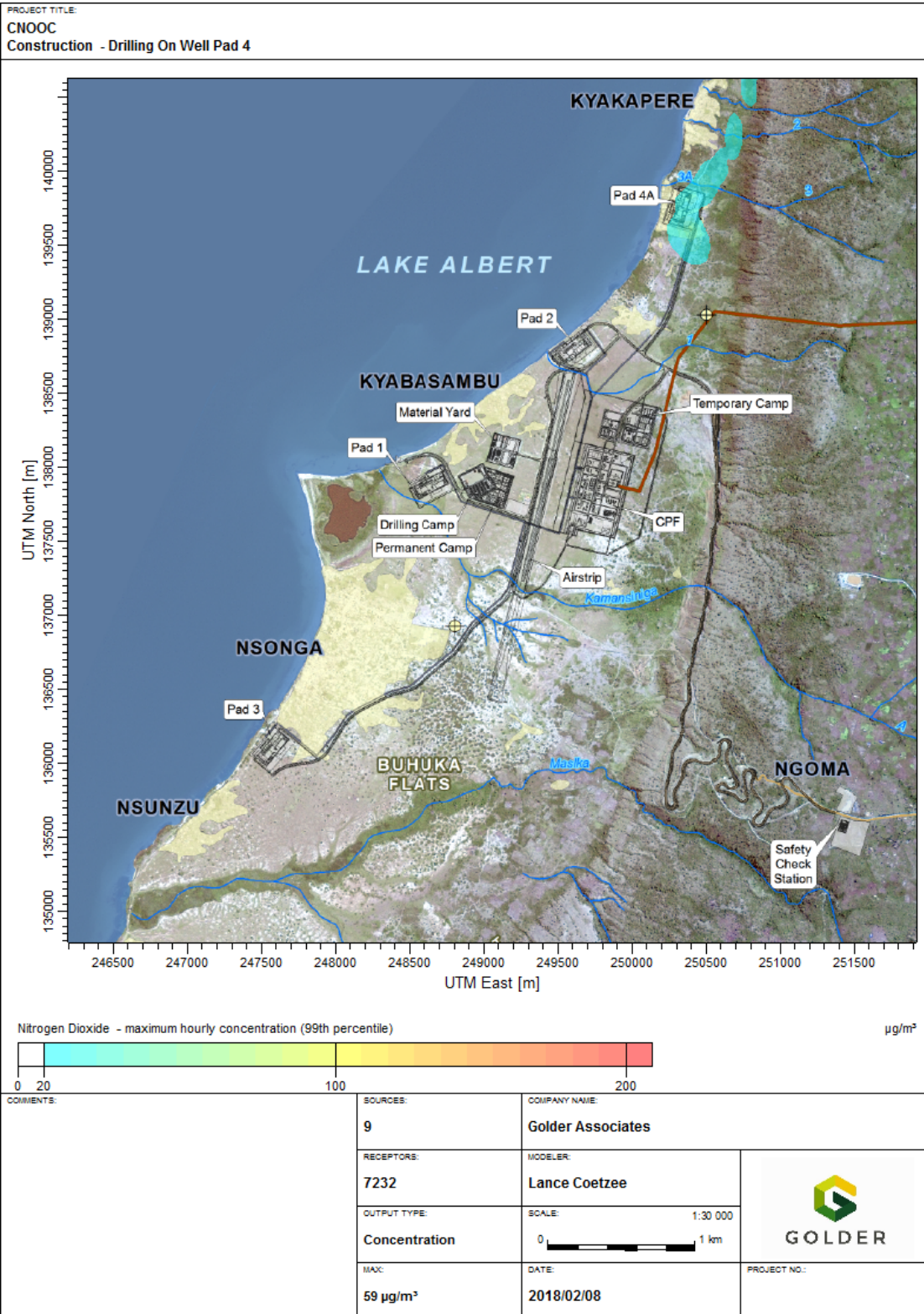

Figure 42: Construction - drilling on well pad 4, NO₂ maximum hourly concentration (99th percentile).





AIR QUALITY AND GREENHOUSE GAS ASSESSMENT

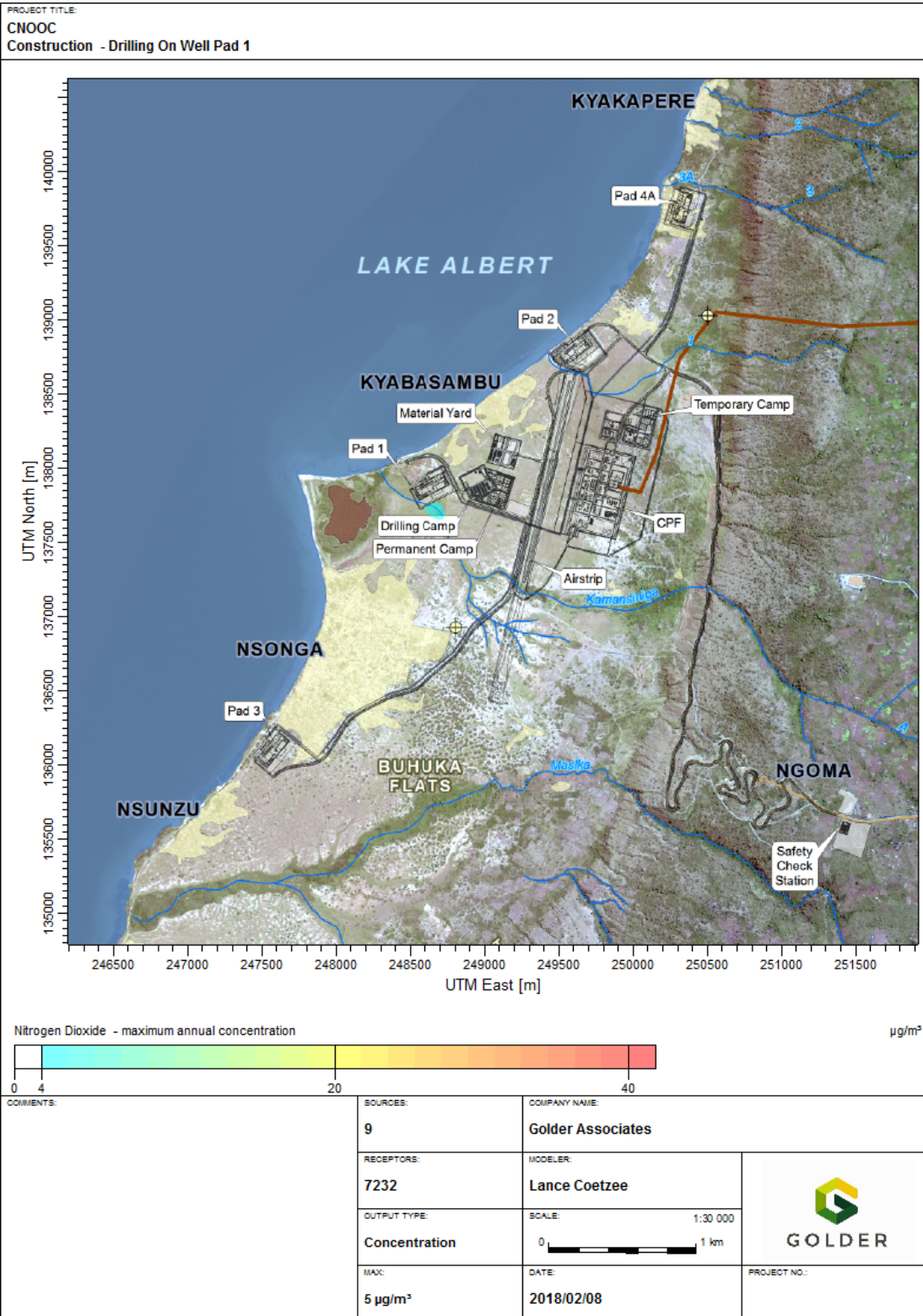

Figure 43: Construction - drilling on well pad 1, NO₂ maximum annual concentration.





AIR QUALITY AND GREENHOUSE GAS ASSESSMENT

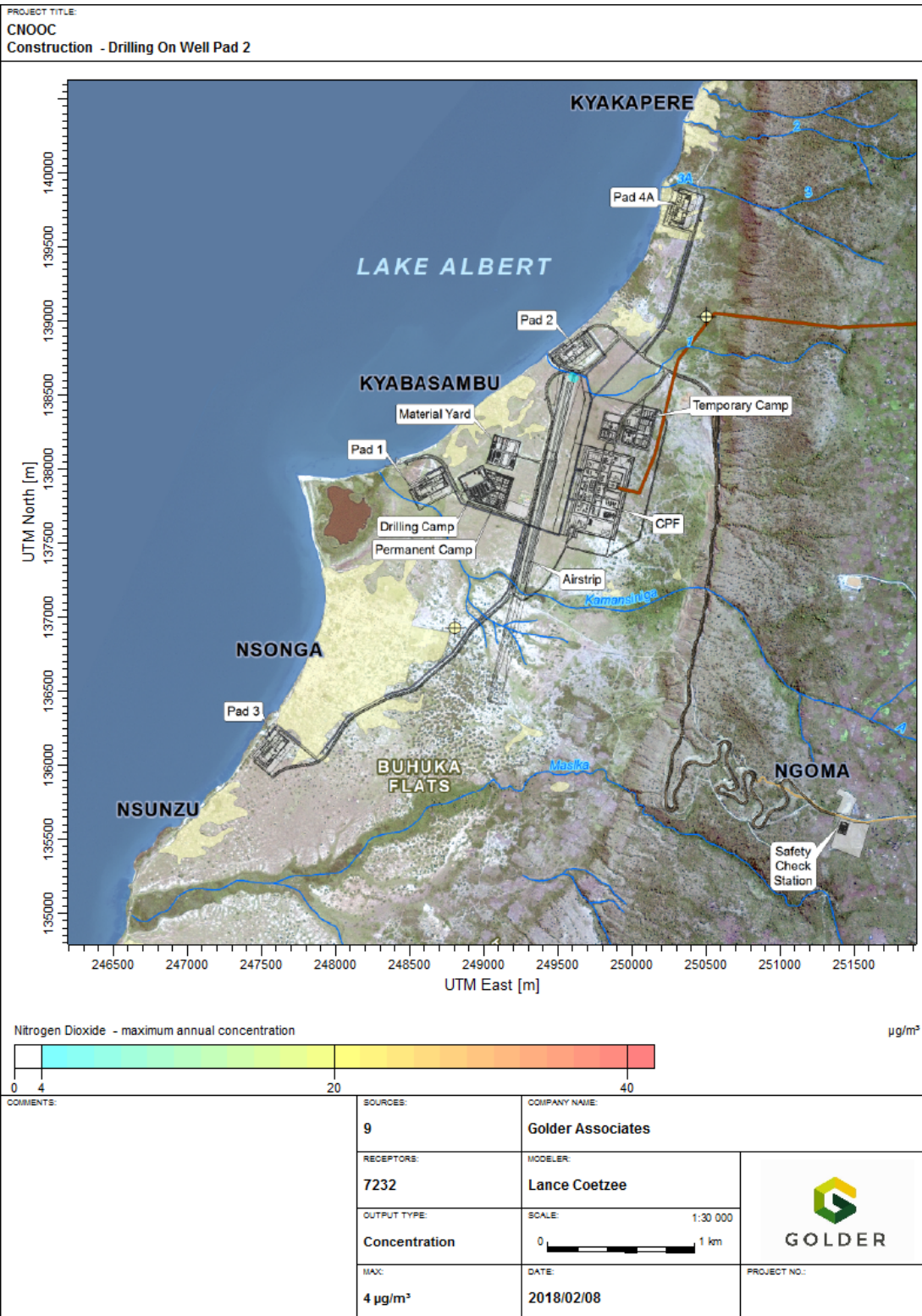

Figure 44: Construction - drilling on well pad 2, NO₂ maximum annual concentration.





AIR QUALITY AND GREENHOUSE GAS ASSESSMENT

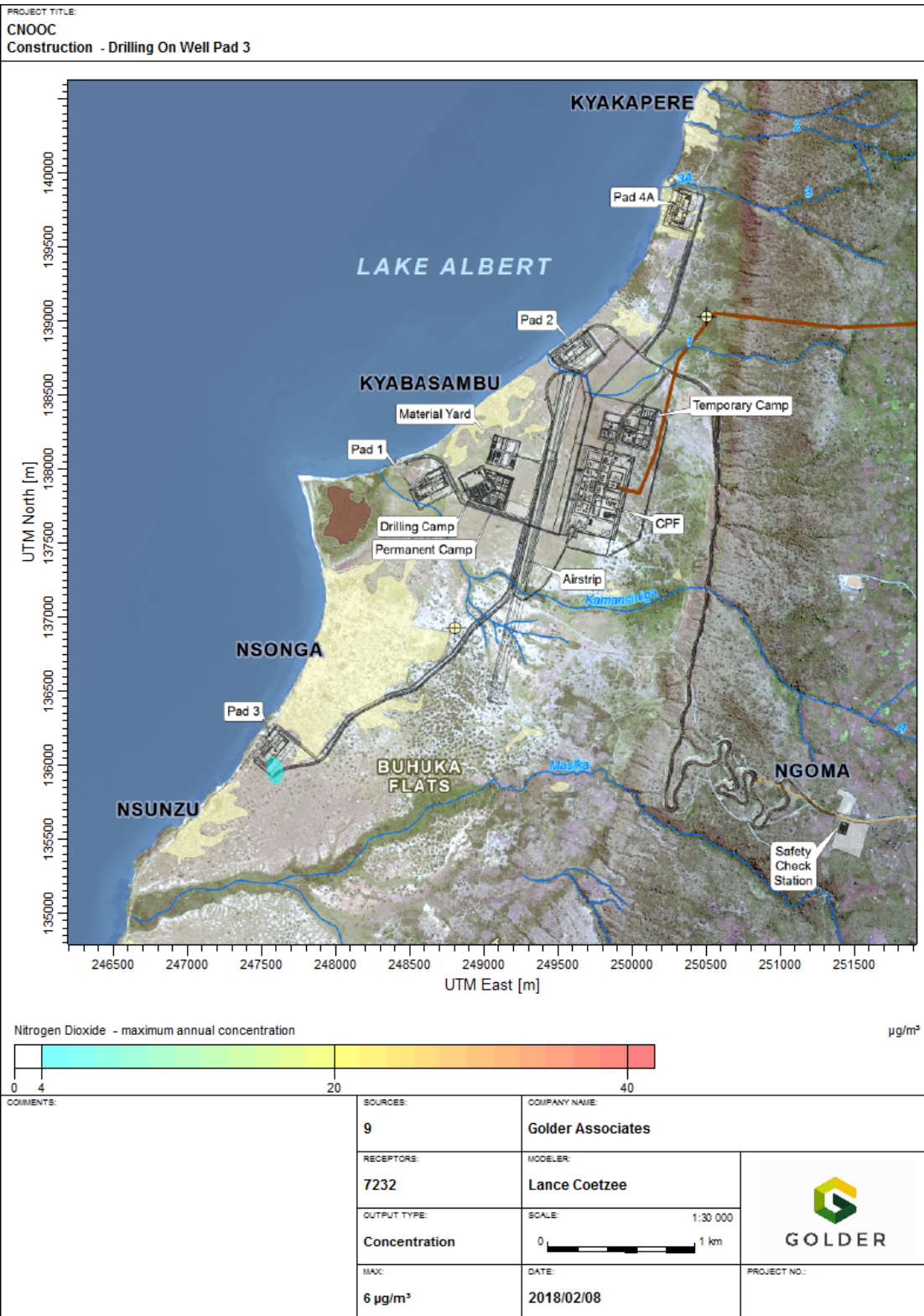

Figure 45: Construction - drilling on well pad 3, NO₂ maximum annual concentration.





AIR QUALITY AND GREENHOUSE GAS ASSESSMENT

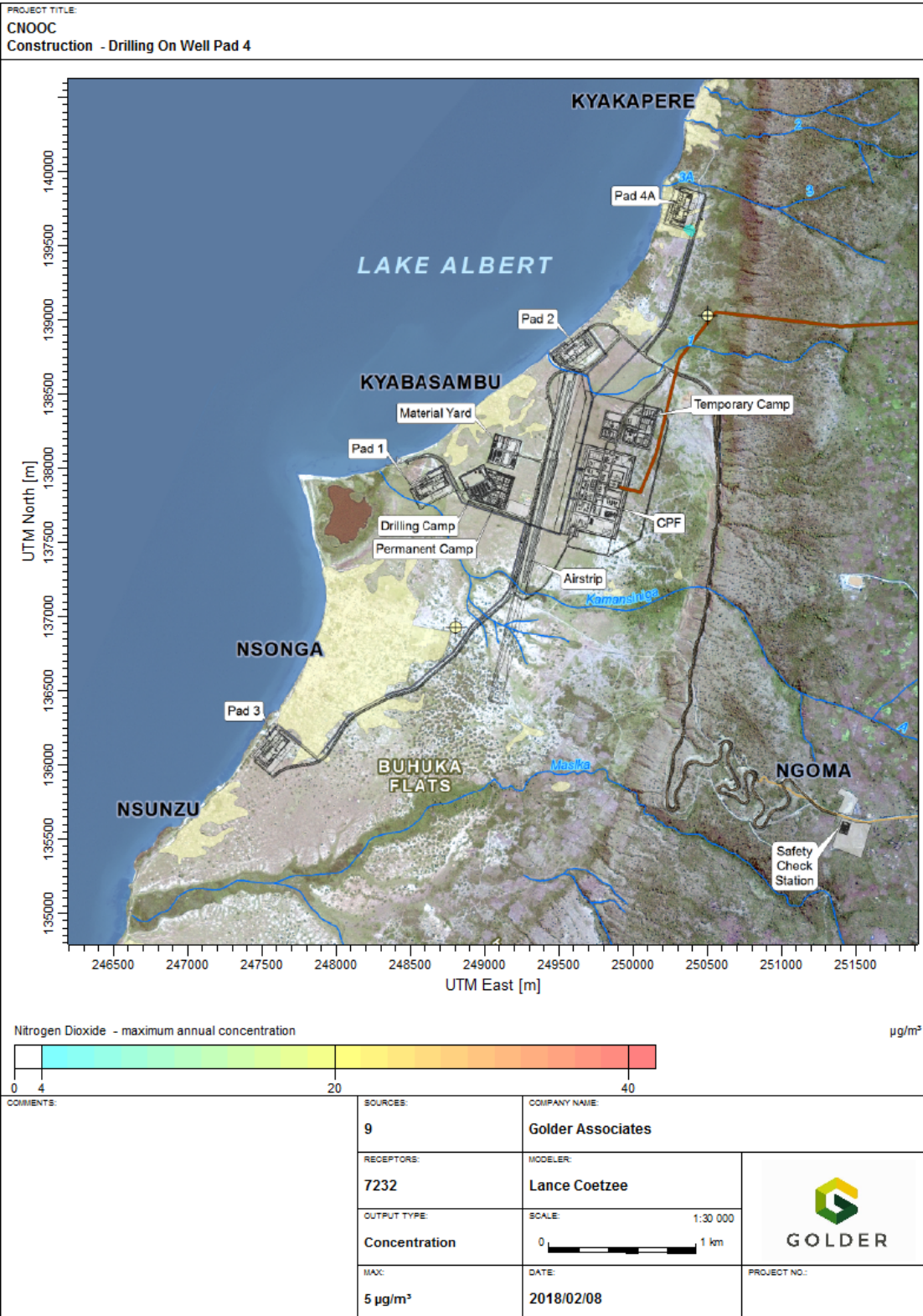

Figure 46: Construction - drilling on well pad 4, NO₂ maximum annual concentration.





AIR QUALITY AND GREENHOUSE GAS ASSESSMENT

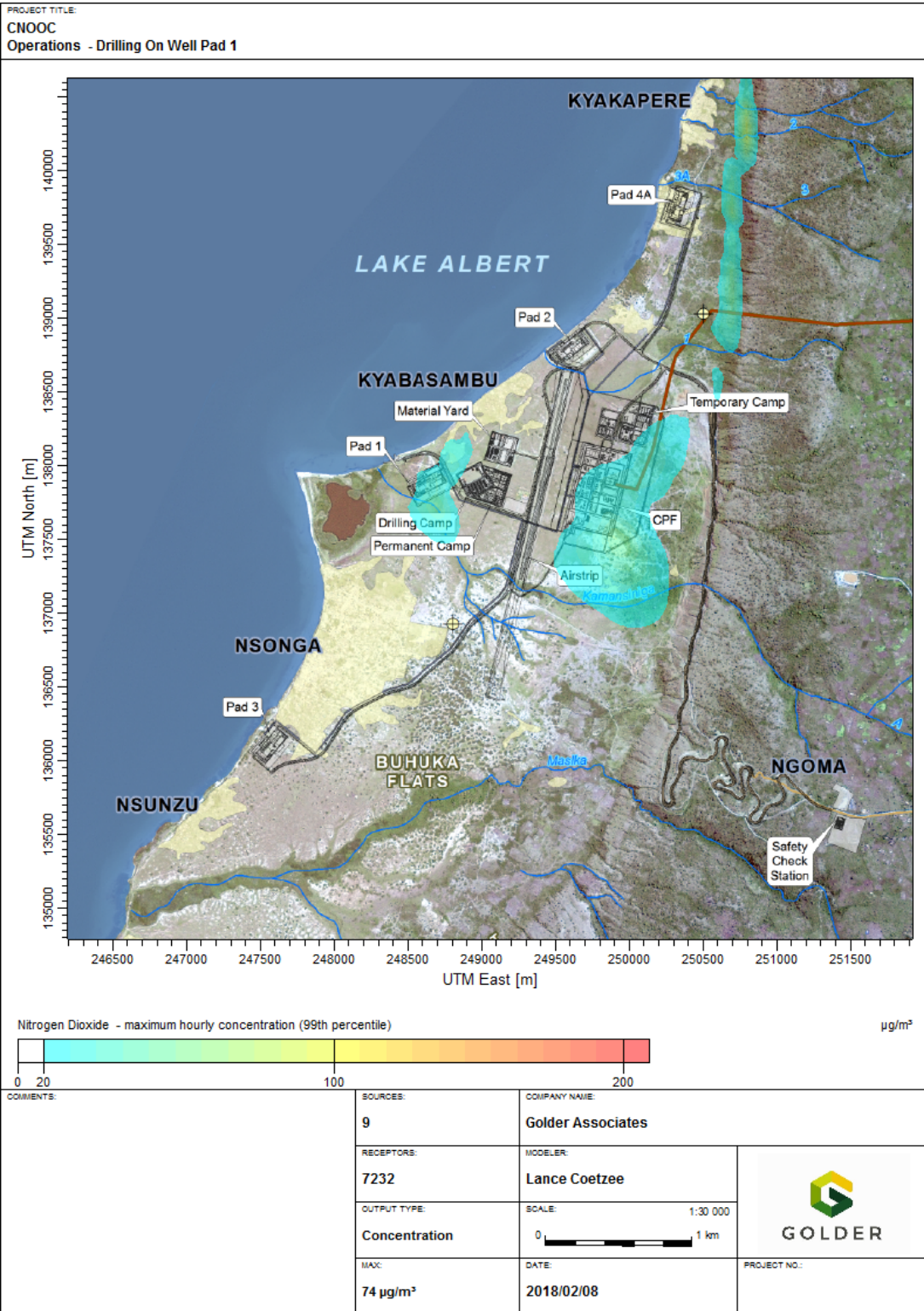

Figure 47: Operations - drilling on well pad 1, NO_2 maximum hourly concentration (99th percentile).





AIR QUALITY AND GREENHOUSE GAS ASSESSMENT

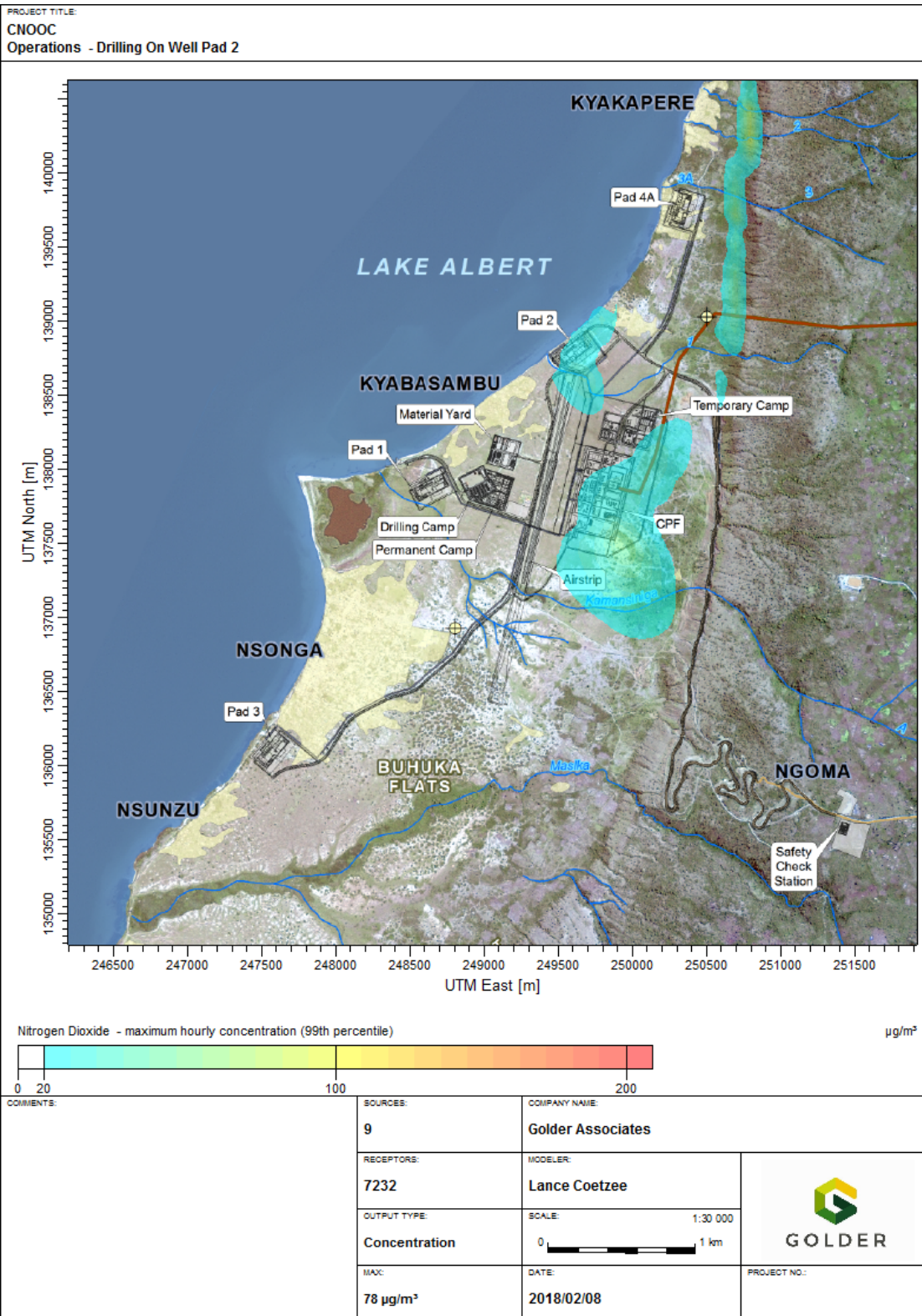

Figure 48: Operations - drilling on well pad 2, NO_2 maximum hourly concentration (99th percentile).





AIR QUALITY AND GREENHOUSE GAS ASSESSMENT

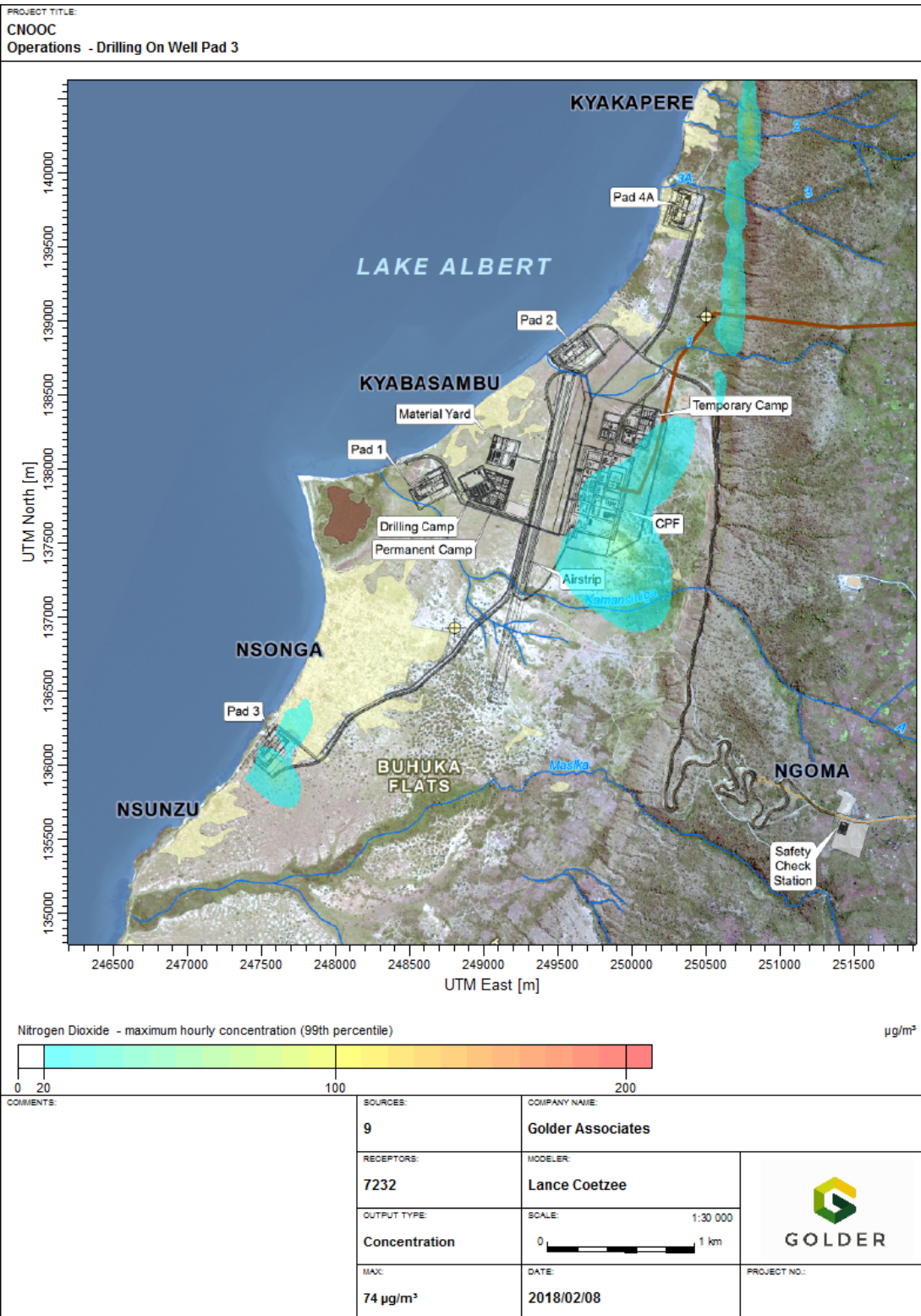

Figure 49: Operations - drilling on well pad 3, NO_2 maximum hourly concentration (99th percentile).





AIR QUALITY AND GREENHOUSE GAS ASSESSMENT

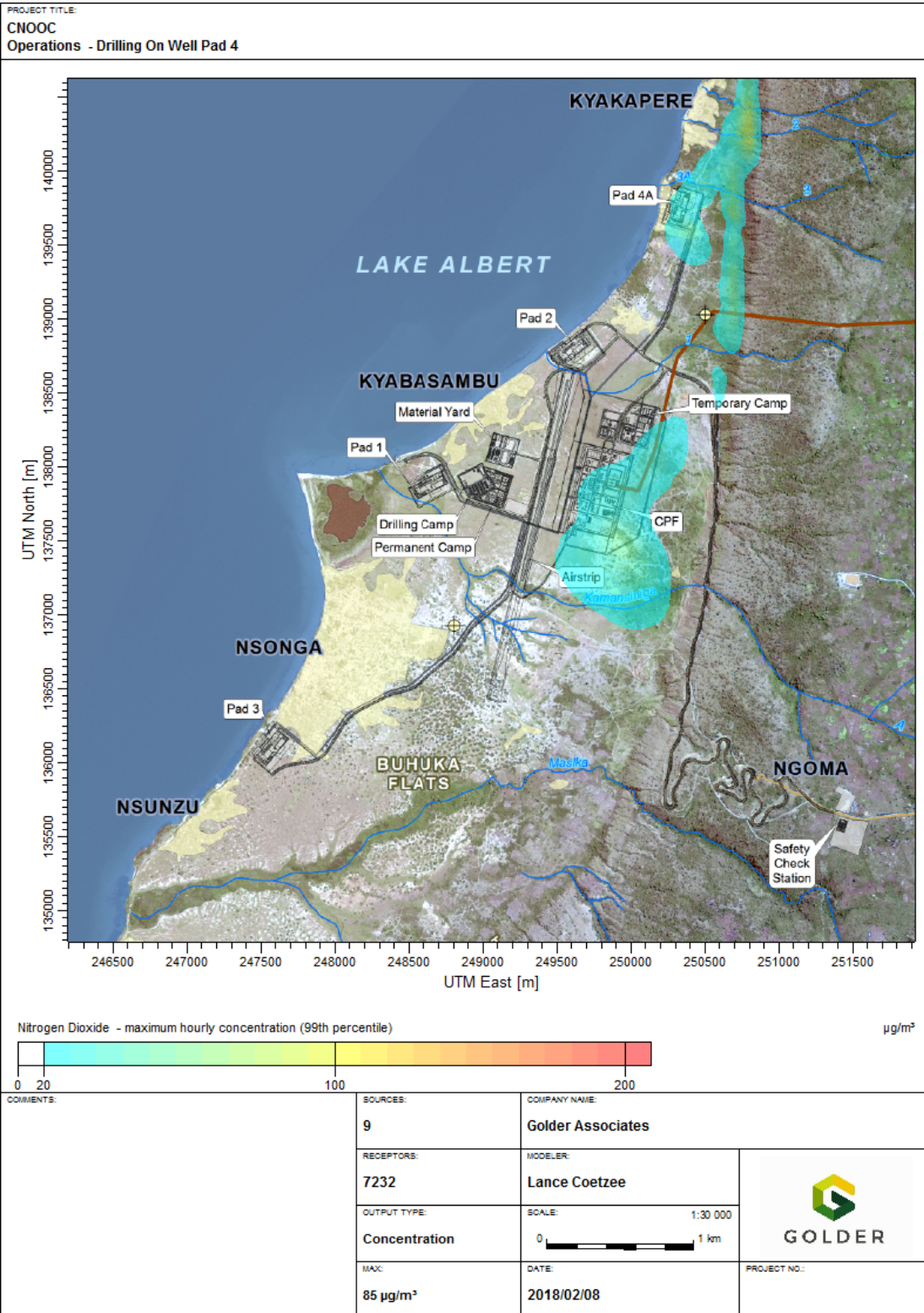

Figure 50: Operations - drilling on well pad 4, NO₂ maximum hourly concentration (99th percentile).





AIR QUALITY AND GREENHOUSE GAS ASSESSMENT

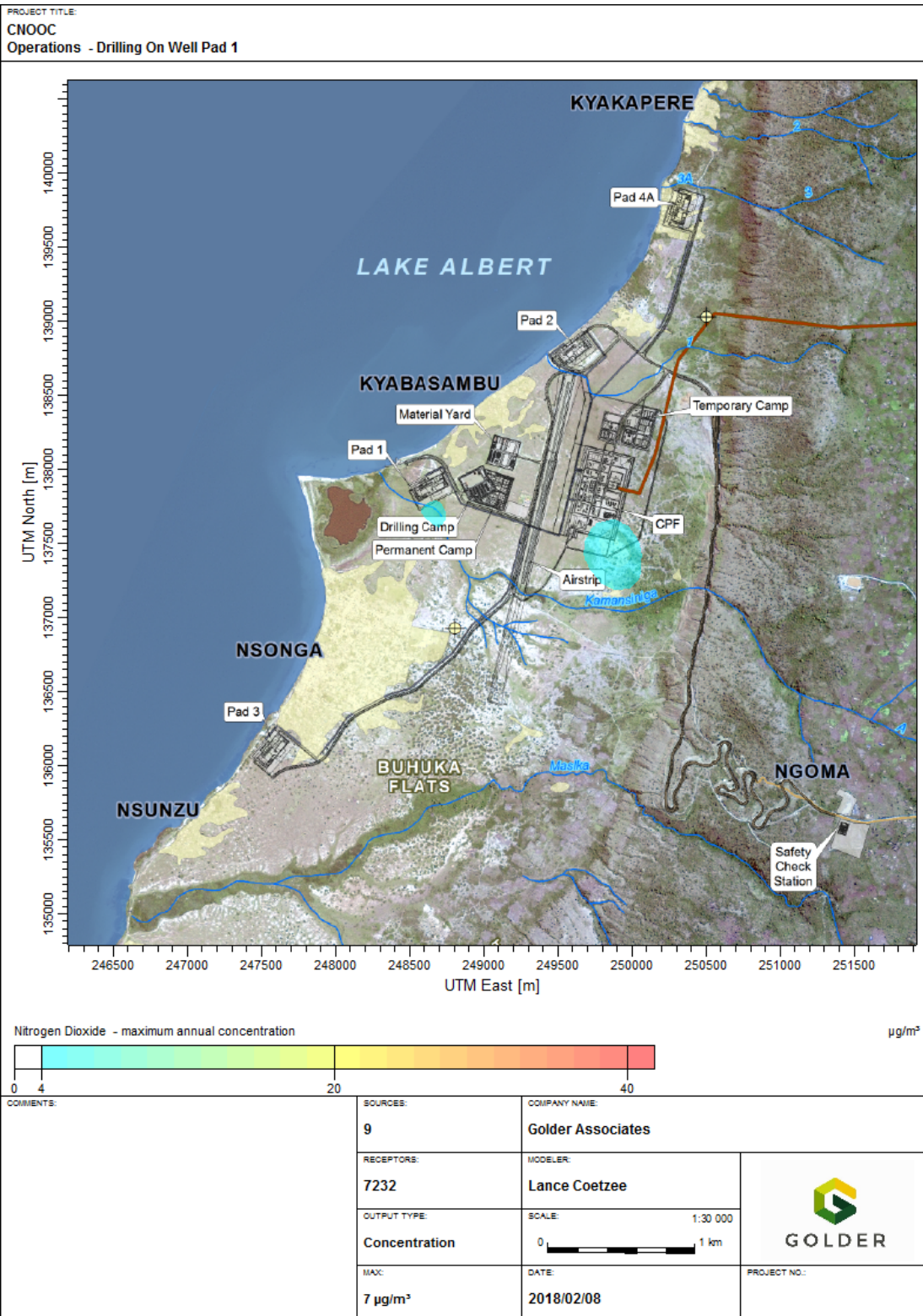

Figure 51: Operations - drilling on well pad 1, NO₂ maximum annual concentration.





AIR QUALITY AND GREENHOUSE GAS ASSESSMENT

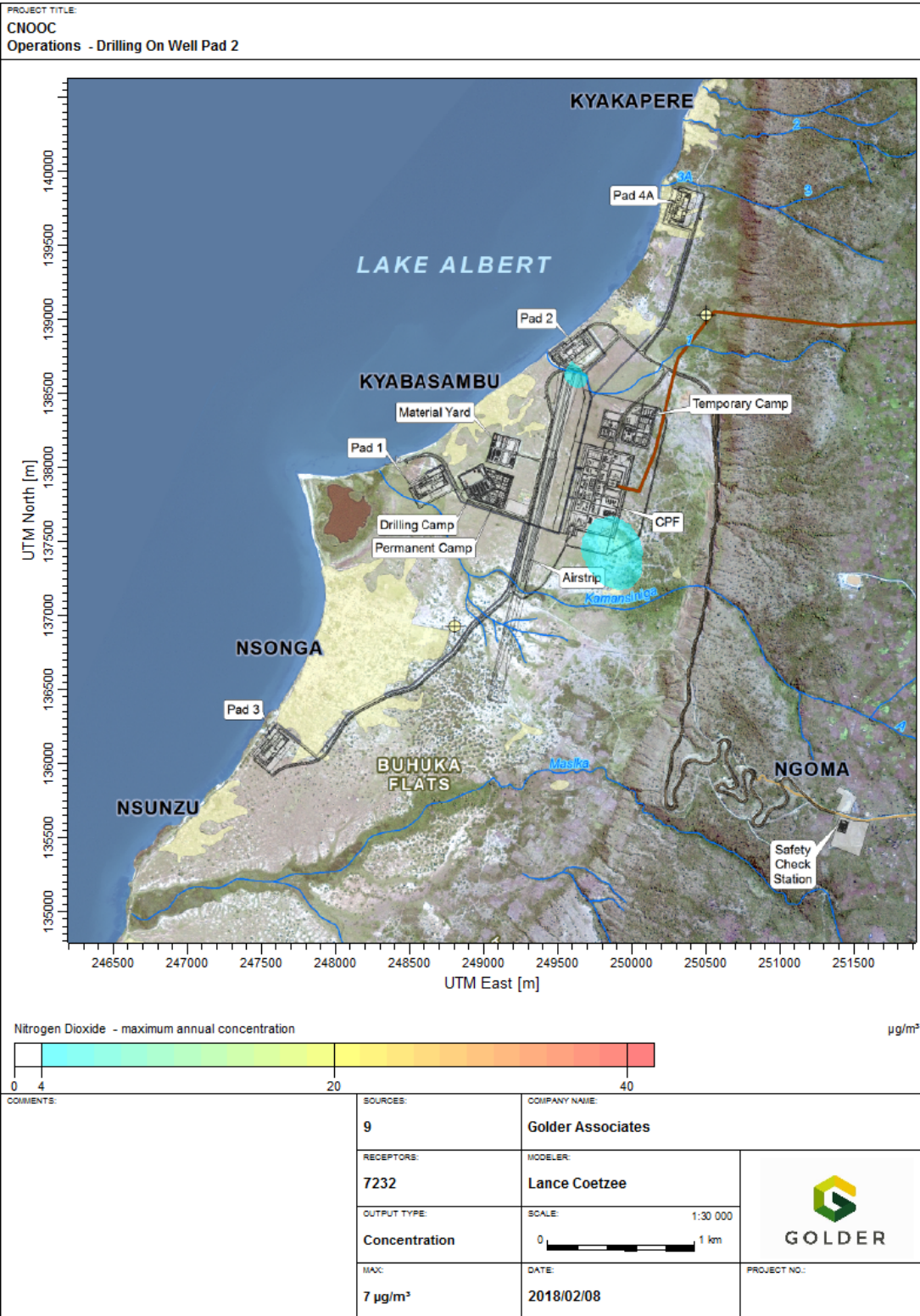

Figure 52: Operations - drilling on well pad 2, NO₂ maximum annual concentration.





AIR QUALITY AND GREENHOUSE GAS ASSESSMENT

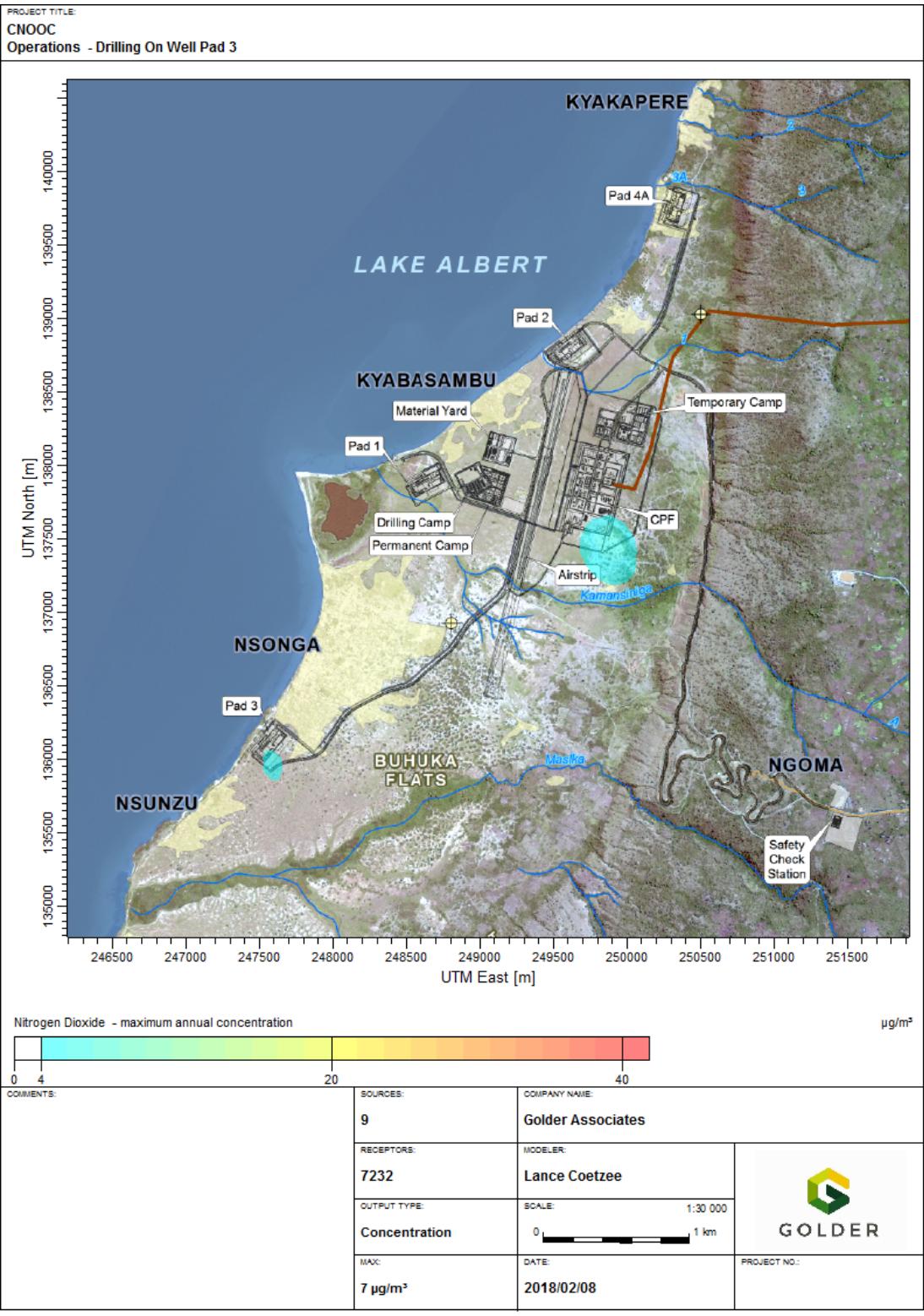

Figure 53: Operations - drilling on well pad 3, NO₂ maximum annual concentration.





AIR QUALITY AND GREENHOUSE GAS ASSESSMENT

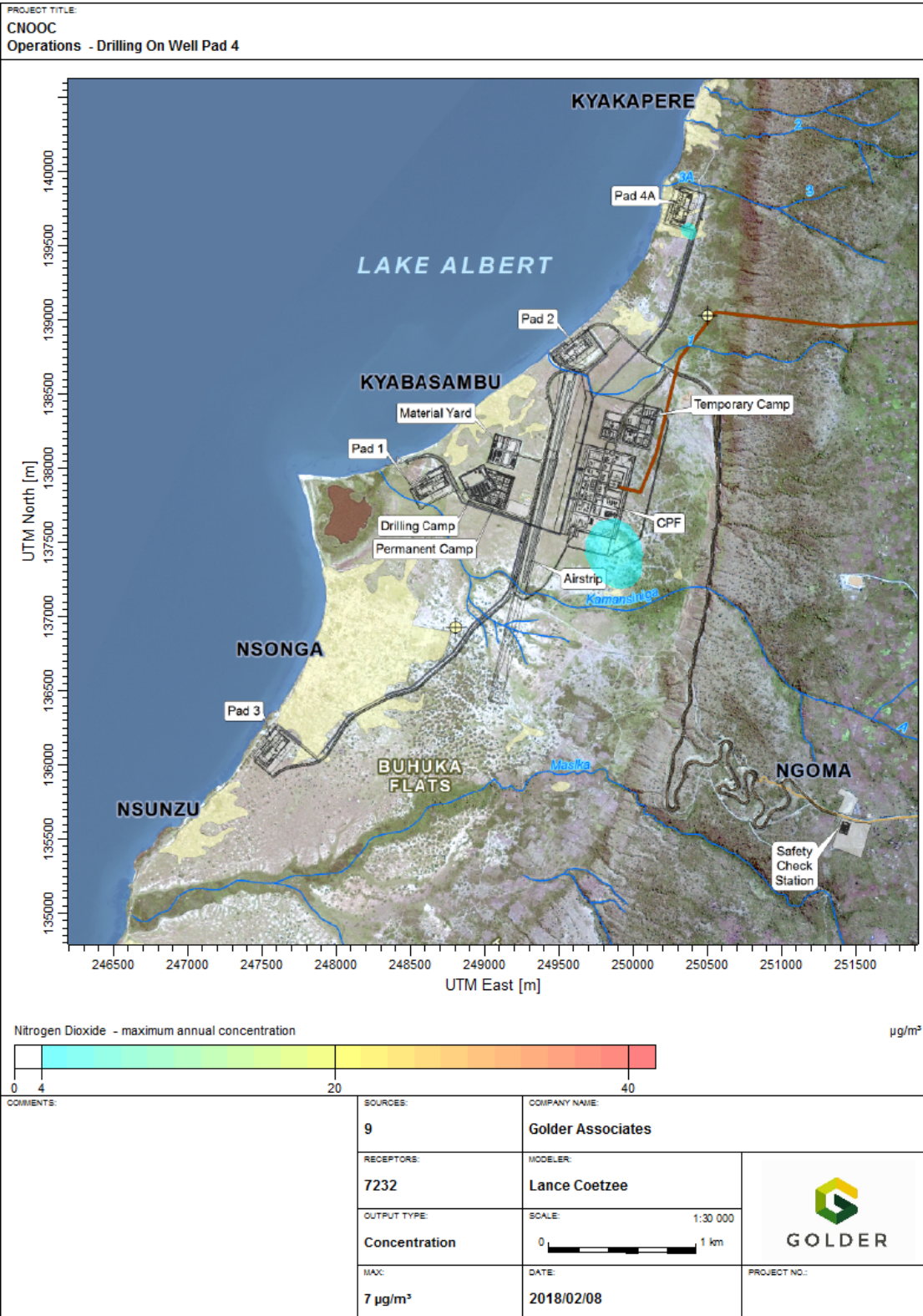

Figure 54: Operations - drilling on well pad 4, NO₂ maximum annual concentration.





4.5 Air Quality Impact Assessment

4.5.1 Project impact rating

Impacts ratings for this air quality impact assessment were based on the temporal intensities of various atmospheric pollutants experienced by various valued environmental and social components (VEC's). Sensitivity classifications for identified VEC's are provided in Table 21.

Table 21: Impact assessment criteria and rating scale – Air Quality

Criterion	Rating	Definition
Magnitude (the expected magnitude or size of the impact)	Negligible	Pollutant concentration ≤ 25% of guidelines. ⁵
	Very Low	Pollutant concentration >25% and ≤ 50% of guidelines.
	Moderate	Pollutant concentration >50% and ≤ 100% of guidelines.
	Major	Pollutant concentration >100% of guidelines.
Sensitivity of Receptor (VEC)	Negligible	Infrastructure (no human exposure).
	Very Low	Infrastructure (worker occupational exposure).
	Moderate	Camps (worker medium-term exposure)
	Major	Villages (public long-term / repeated exposure)

Impact ratings for construction, operation and decommissioning are provided in Table 22, Table 23 and Table 24. In alignment with IFC requirements impacts as a result of the proposed project as well as existing impacts were assessed to provide cumulative impacts⁶.

⁵ As a general rule, the IFC General EHS Guideline suggests 25% percent of the applicable air quality standards to allow additional, future sustainable development in the same airshed.

⁶ A cumulative impact, in relation to an activity, is the impact of an activity that may not be significant in isolation, but may become significant when added to the existing and potential impacts arising from similar or other activities in the area.





AIR QUALITY AND GREENHOUSE GAS ASSESSMENT

Table 22: Air quality impact assessment rating for construction

Impact	Location	Project Impact			Cumulative Impact			Impact After Mitigation		
		Magnitude	Sensitivity	Significance	Magnitude	Sensitivity	Significance	Magnitude	Sensitivity	Significance
Degradation of airshed due to increased particulate and / or trace gas concentrations as a result of the project.	Access Roads	3	4	12	4	4	16	2	4	8
	Airstrip	3	2	6	4	2	8	2	2	4
	CPF	3	2	6	4	2	8	2	2	4
	CPF Camps	3	3	9	4	3	12	2	3	6
	Escarpment Camp	3	3	9	4	3	12	2	3	6
	Escarpment Road	3	4	12	4	4	16	2	4	8
	Flow Lines	3	1	3	4	1	4	2	1	2
	Pipeline	3	1	3	4	1	4	2	1	2
	Well Pads	3	2	6	4	2	8	2	2	4
	Busigi	1	4	4	1	4	4	1	4	4
	Ilkamiro	1	4	4	1	4	4	1	4	4
	Kacunde	1	4	4	1	4	4	1	4	4
	Kiina	1	4	4	1	4	4	1	4	4
	Kyabasambu	2	4	8	2	4	8	2	4	8
	Kyakapere	2	4	8	2	4	8	2	4	8
	Kyenyanya	1	4	4	1	4	4	1	4	4
	Ngoma	1	4	4	1	4	4	1	4	4
	Nsonga	2	4	8	2	4	8	2	4	8
	Nsunzu	2	4	8	2	4	8	2	4	8
	Sangarao	1	4	4	1	4	4	1	4	4
Senjonjo	1	4	4	1	4	4	1	4	4	
Ususa	1	4	4	1	4	4	1	4	4	





AIR QUALITY AND GREENHOUSE GAS ASSESSMENT

Table 23: Air quality impact assessment rating for operations

Impact	Location	Project Impact			Cumulative Impact			Impact After Mitigation		
		Magnitude	Sensitivity	Significance	Magnitude	Sensitivity	Significance	Magnitude	Sensitivity	Significance
Degradation of airshed due to increased particulate and / or trace gas concentrations as a result of the project.	Access Roads	2	4	8	3	4	12	2	4	8
	Airstrip	2	2	4	3	2	6	2	2	4
	CPF	2	2	4	3	2	6	2	2	4
	CPF Camps	2	3	6	3	3	9	2	3	6
	Escarpment Camp	2	3	6	3	3	9	2	3	6
	Escarpment Road	2	4	8	3	4	12	2	4	8
	Flow Lines	1	1	1	2	1	2	1	1	1
	Pipeline	1	1	1	2	1	2	1	1	1
	Well Pads	2	2	4	3	2	6	2	2	4
	Busigi	1	4	4	1	4	4	1	4	4
	Ilkamiro	1	4	4	1	4	4	1	4	4
	Kacunde	1	4	4	1	4	4	1	4	4
	Kiina	1	4	4	1	4	4	1	4	4
	Kyabasambu	2	4	8	3	4	12	2	4	8
	Kyakapere	2	4	8	3	4	12	2	4	8
	Kyenyanya	1	4	4	1	4	4	1	4	4
	Ngoma	1	4	4	1	4	4	1	4	4
	Nsonga	2	4	8	3	4	12	2	4	8
	Nsunzu	2	4	8	3	4	12	2	4	8
	Sangarao	1	4	4	1	4	4	1	4	4
Senjonjo	1	4	4	1	4	4	1	4	4	
Ususa	1	4	4	1	4	4	1	4	4	





AIR QUALITY AND GREENHOUSE GAS ASSESSMENT

Table 24: Air quality impact assessment rating for decommissioning

Impact	Location	Project Impact			Cumulative Impact			Impact After Mitigation		
		Magnitude	Sensitivity	Significance	Magnitude	Sensitivity	Significance	Magnitude	Sensitivity	Significance
Degradation of airshed due to increased particulate and / or trace gas concentrations as a result of the project.	Access Roads	1	4	4	1	4	4	1	4	4
	Airstrip	1	2	2	1	2	2	1	2	2
	CPF	1	2	2	1	2	2	1	2	2
	CPF Camps	1	3	3	1	3	3	1	3	3
	Escarpment Camp	1	3	3	1	3	3	1	3	3
	Escarpment Road	1	4	4	1	4	4	1	4	4
	Flow Lines	1	1	1	1	1	1	1	1	1
	Pipeline	1	1	1	1	1	1	1	1	1
	Well Pads	1	2	2	1	2	2	1	2	2
	Busigi	1	4	4	1	4	4	1	4	4
	Ilkamiro	1	4	4	1	4	4	1	4	4
	Kacunde	1	4	4	1	4	4	1	4	4
	Kiina	1	4	4	1	4	4	1	4	4
	Kyabasambu	1	4	4	1	4	4	1	4	4
	Kyakapere	1	4	4	1	4	4	1	4	4
	Kyenyanja	1	4	4	1	4	4	1	4	4
	Ngoma	1	4	4	1	4	4	1	4	4
	Nsonga	1	4	4	1	4	4	1	4	4
	Nsunzu	1	4	4	1	4	4	1	4	4
Sangarao	1	4	4	1	4	4	1	4	4	
Senjonjo	1	4	4	1	4	4	1	4	4	
Ususa	1	4	4	1	4	4	1	4	4	





4.5.2 Construction

Exceedances of the short term (daily) IFC PM₁₀ and PM_{2.5} guidelines are anticipated during construction (land clearing, preparation and construction). These impacts will be transient and can be effectively mitigated.

4.5.3 Operation

Simulations performed to assess NO₂, SO₂, PM₁₀, PM_{2.5} and VOC dispersion as a result of emissions from the project predicted that IFC guidelines would not be exceeded.

VEC's most adversely affected include the villages of:

- Kyakapere;
- Kyabasambu;
- Nsonga; and,
- Nsunzu.

4.5.4 Decommissioning

Atmospheric emissions from the project will stop at closure; therefore no adverse residual⁷ air quality impacts are anticipated.

4.6 Conclusions and Recommendations

Adverse air quality ratings predicted for construction activities are mainly as a result of both short-term and impacts of particulates, and adverse air quality ratings predicted for operations mainly as a result of short and long term NO₂ impacts. Impacts from SO₂, H₂S and VOC's were predicted to be very low. Measure aimed at mitigation emissions from the project are provided in Table 25

⁷ Residual impacts are significant project-related impacts that might remain after on-site mitigation measures (avoidance, management controls, abatement, restoration, etc.) have been implemented.



AIR QUALITY AND GREENHOUSE GAS ASSESSMENT

Table 25: Air quality management plan.

Phase	Impacts	Objective	Detailed Mitigation measures	Monitoring Mechanism	Target Performance indicator /	Responsibility
Construction / Operations	Impact of increase in ambient particulate concentrations due to vehicles, construction works, drilling, and dust from exposed areas.	Avoid and/or reduce dust	<ul style="list-style-type: none"> ■ Wet suppression, wet misting during materials handling activities; ■ Wind speed reduction through sheltering or wind breaks for open exposed areas prone to wind erosion (where possible); ■ Covering or keeping stockpile heights as low as practicable to reduce their exposure to wind erosion and thus dust generation; ■ Progressive rehabilitation and re-vegetation; ■ Reduction in unnecessary traffic volumes; ■ Wet suppression on all unpaved roads with water or a suitable dust palliative to achieve 50% control efficiency or better (note: water alone will only achieve a 75% control efficiency); ■ Park vehicles off travelled roadways; and ■ Rigorous speed control and the institution of traffic calming measures to reduce vehicle dust entrainment. 	Ambient dust/particulate matter monitoring	Compliance with local and international regulations	Environmental Department
Construction / Operations	Impact of increase in ambient trace gas concentrations due to vehicles, construction works, power generation, and drilling.	Minimise trace gas emissions	<ul style="list-style-type: none"> ■ Maintain and service all vehicles and diesel generators regularly to ensure that exhaust particulate and trace gas emissions are kept to a minimum with post combustion control measures; ■ Where possible, use low sulphur fuels to reduce SO₂ emissions ■ Maintain a site wide emissions inventory for the mining operation; 	Ambient trace gas monitoring	Compliance with local and international regulations	Environmental Department





AIR QUALITY AND GREENHOUSE GAS ASSESSMENT

Phase	Impacts	Objective	Detailed Mitigation measures	Monitoring Mechanism	Target Performance / indicator	Responsibility
			<ul style="list-style-type: none"> ■ Re run the air dispersion model to quantify the mining operations ambient air quality impacts on the surrounding environment every 5 years or when a significant change to operations takes place; ■ Operate and maintain a site specific particulate monitoring and trace gas monitoring network; ■ The air quality monitoring network should undergo and annual audit and optimization study to ensure that the network is maintained in alignment with best practice and is relevant to the key emission sources on the ground; and ■ The emissions inventory and model should feed into future updates of the air quality management plan. 			
Operations	Impact of increase in ambient trace gas concentration due to power generation, heating and flaring.	Minimise trace gas emissions	<ul style="list-style-type: none"> ■ Implement post combustion control measures on engines; control technologies applicable to these sources include selective catalytic reduction (SCR), non-selective catalytic reduction (NSCR), and catalytic oxidation (CO oxidation catalyst). ■ Implement annual emission testing. 	Ambient air quality monitoring / emission testing	Compliance with local and international regulations	Environmental Department





5.0 REFERENCES

- EA-NPI. (1999). *Emission Estimation Technique Manual for Gas Supply*. Environment Australia - National Pollutant Inventory.
- EA-NPI. (2008). *Emission Estimation Technique Manual for Combustion Engines Version 3.0 June 2008*. Environment Australia - National Pollutant Inventory.
- EA-NPI. (2012). *Emission Estimation Technique Manual for Fuel and Organic Liquid Storage*. Environment Australia - National Pollutant Inventory.
- EA-NPI. (2012). *Emission Estimation Technique Manual for Fugitive Emissions Version 2.0 January 2012*. Environment Australia - National Pollutant Inventory.
- EA-NPI. (2013). *Emission Estimation Technique Manual for Oil and Gas Extraction and Production Version 2.0 July 2013*. Environment Australia - National Pollutant Inventory.
- IFC. (2007). *Environmental, Health and Safety Guidelines for Large Volume Inorganic Compounds Manufacturing and Coal Tar Distillation*. World Bank Group, International Finance Corporation.
- IFC. (2007). *Environmental, Health, and Safety Guidelines for Onshore Oil and Gas Development*. World Bank Group, International Finance Corporation.
- IFC. (2007). *Environmental, Health, and Safety Guidelines, General EHS Guidelines: Environmental Air Emissions and Ambient Air Quality*. World Bank Group, International Finance Corporation.
- US-EPA. (2000). *Emission Factor Documentation for Ap-42 Section 3.2, Natural Gas-Fired Reciprocating Engines*.
- WHO. (2000). *Air Quality Guidelines for Europe, Second Edition*. World Health Organisation.
- WHO. (2005). *WHO Air Quality Guidelines for Particulate Matter, Ozone, Nitrogen Dioxide and Sulfur Dioxide, Global update 2005, Summary of Risk Assessment*. World Health Organisation.
- WRI-WBCFSD. (2004). *The Greenhouse Gas Protocol - A Corporate Accounting and Reporting Standard*. World Resources Institute / World Business Council for Sustainable Development.
- WRI-WBCFSD. (2005). *GHG Protocol - Calculation Tool for Direct Emissions from Stationary Combustion*. World Resources Institute / World Business Council for Sustainable Development.



GOLDER ASSOCIATES AFRICA (PTY) LTD.

Author: Candice Allan
Climate change and air quality specialist
MSc Geographic Sci., BSc.Hons. Environ &
Geographic Sci, BSc Geo Scio.

Senior review: Lance Coetzee
Air Quality Consultant
NHD.Chem, ND.Chem





October 2017

REPORT – VOLUME 4, STUDY 2



CNOOC UGANDA LIMITED

**KINGFISHER OIL PROJECT,
HOIMA DISTRICT, UGANDA -
SURFACE WATER
SPECIALIST REPORT**

Submitted to:

The Executive Director National Environment Management Authority, NEMA House,
Plot 17/19/21 Jinja Road, P. O. Box 22255 Kampala, Uganda

Report Number: 1776816-321512-13

Distribution:

- 1 x electronic copy CNOOC Uganda Limited
- 1 x electronic copy NEMA
- 1 x electronic copy Eco & Partner
- 1 x electronic copy Golder





EXECUTIVE SUMMARY

This report presents hydrology baseline information and an impact assessment of surface water hydrology affected by the Project. An understanding of surface water hydrological conditions prior to mine oil and gas development is essential to assess changes in water availability that could affect local users. Changes in hydrology can also affect water quality and other resources such as fish habitat, vegetation and wildlife. Hydrological data is further required to design mine oil and gas facilities (e.g. culverts, channels and storage ponds).

The regional climate in the area is described as tropical with a distinct wet and dry season. Rainfall over the study area catchment varies between 700 mm and 1 400 mm/ annum. Results of Global Climate Change models indicate that Uganda is likely to experience more extreme periods of intense rainfall and drought, while the rainfall seasons become more erratic and/or infrequent.

The project site is located within the Kingfisher catchment and drains westwards into the south eastern embankments of Lake Albert. Kingfisher catchment is associated with a very high western rift escarpment that drains into Lake Albert via several scattered streams and wetlands flowing westwards. Streams within the project zone of influence include the Kamansing and Masikia Rivers. With the exception of these rivers, the area below the escarpment (approximately 13 km²) is characterised by relatively spread out wetlands at an elevation associated with most project infrastructure (628 mamsl). The water system of the Flats is a localised system and a conceptual model of the Flats hydrological system is shown below.

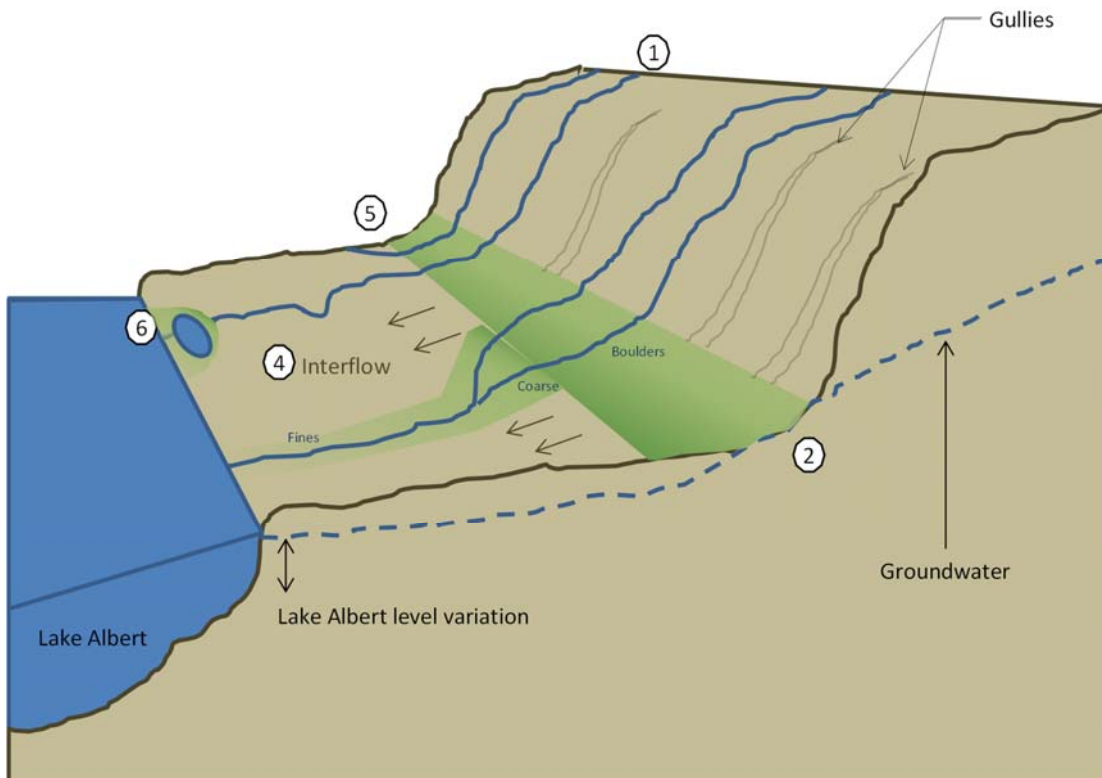

The model shows that in the rainy season, runoff is discharged onto the Flats from the catchment (65 km²). Water is conveyed through ravines on the steep slopes of the escarpment (1). Water energy is high when it reaches the Flats but it dissipates quickly as the slope flattens and encounters bushy vegetation at the bottom of the escarpment. This is a zone of recharge where water infiltrates into the soil.





During the dry season, the Flats still receive some water from the upstream catchment through soil moisture stored during the rainy season and groundwater seepage (2). Evidence of groundwater seepage is given by a 100 m high band of green vegetation visible on the lower part of the escarpment during the dry season. Some smaller streams disappear from the surface a few hundred metres away from the bottom of the escarpment, indicating that the bottom of the escarpment is an important zone of recharge of water into the soil. Water contributes to recharging the aquifer, and also moves through the soil towards Lake Albert (4), while the rest is evaporated. Streams that are large enough slowly make their way through densely vegetated wetlands.

An important feature within the Flats system is a pond near the jetty ('Luzira') (6). Little is known about the hydrological behaviour of this system. During the dry season, the water level in the pond was measured to be lower than the level of Lake Albert. No water inflow was visible on the surface. It is very likely that the pond receives influx of water during the dry season while it overflows into Lake Albert through a large channel during the wet season.

Overall, water quality during the dry season is generally good. A concern could be during the wet season where humic acids from surrounding land areas such as wetland systems may possibly increase pH levels and introduce metals into Lake Albert

Impact Assessment

The potential impacts of the project during the construction phase and operation phases are listed and ranked in tables below.

Potential impacts during the construction phase.

No.	Potential Impact	Pre-Mitigation	Post- Mitigation
		Impact severity	
C1	Increased erosion and runoff volumes	Moderate	Minor
C2	Increased dust and sedimentation in drainage streams	Moderate	Minor
C3	Altering the banks and beds of streams by the construction of the pipeline	Moderate	Minor
C4	Spillage of oils, fuel and chemicals polluting water resources	Major	Moderate
C5	Discharge of poor quality effluent from the sewage works at the temporary camp	Moderate	Minor



Potential impacts during the operational phase.

No.	Potential Impact	Magnitude (the expected magnitude or size of the impact)	Sensitivity of the Receptor	Severity	Magnitude (the expected magnitude or size of the impact)	Sensitivity of the Receptor	Severity
O1	Reduction in catchment area	Low	Low	Minor	Very Low	Very Low	Negligible
O2	Increased erosion, dust and sedimentation	Low	Low	Minor	Very Low	Very Low	Negligible
O3	Discharge of poor quality storm water from CPF	Medium	High	Major	Low	Medium	Moderate
O4	Spillage of crude oil from Well pads and CPF	Medium	High	Major	Low	Low	Minor
O5	Infrastructure crossing natural drainage lines	Medium	High	Major	Low	Low	Minor
O6	Oil leaks around pipeline	Medium	High	Major	Low	Medium	Moderate
O7	Rise in water level of Lake Albert	High	High	Major	Low	Medium	Moderate
O8	Decrease in Lake Albert levels	Very low/negligible	High	Minor	Very low	Very Low	Negligible
O9	Discharge of poor quality effluent from the sewage works at the CPF (permanent camp)	Medium	Low	Moderate	Low	Low	Minor

Mitigation measures proposed for the Construction phase include:

- **Prevention of obstruction of water flow:** Impediments to natural water flow shall be avoided, or, if unavoidable, be allowed for in the design by means of appropriately sized and positioned drains, culverts etc.
- **Prevention of surface water pollution by effluent management:** Appropriate use of soak-ways and seepage fields will be put in place to prevent contamination of surface water.
- **Storm water management:** Potentially contaminated storm water shall be kept separate from other drainage at camp sites. Potentially contaminated storm water shall, if necessary, be tested and treated to remove contaminants before being released into the environment.
- **Flood management:** To avoid obstruction to storm water flows, culverts, drains and other means shall be used as necessary.
- **Dust Suppression:** Biodegradable chemical suppression or the use of water sprayers is required to keep the dust levels low and avoid sedimentation in the local surface waters.





- **Sewage water management:** Any discharge from sewage works should meet the IFC Environmental, Health and Safety (EHS) Guidelines for treated sanitary sewage discharge quality.
- **Storm water Management:** Any storm water that has been contaminated by oil, grease or other chemicals from site activity needs to be treated to the discharge standards
- **Process Water Management:** Management of process water to prevent spillages into the environment

Mitigation measures proposed for the Operations phase include:

- **Prevention of obstruction of water flow:** Impediments to natural water flow shall be avoided, or, if unavoidable, be allowed for in the design by means of appropriately sized and positioned drains, culverts etc.
- **Storm water management:** Potentially contaminated storm water shall be kept separate from other drainage at Base camp and other drilling activity sites. Potentially contaminated storm water shall, if necessary, be tested and treated to remove contaminants before being released into the environment.
- **Flood management:**
 - The location of areas prone to flooding relative to the well sites, campsites and access roads shall be confirmed and any consequences of this for drilling programme shall be determined and minimised as soon as possible.
 - Every effort shall be made to ensure the maintenance of the natural flow of water following storm events.
 - No works shall increase the risk of erosion during storm events. Should this be unavoidable specific erosion control measures shall be implemented for the duration of the risk.
- **Sewage water management:** Any discharge from sewage works should meet the IFC Environmental, Health and Safety (EHS) Guidelines for treated sanitary sewage discharge quality.



Acronyms / Abbreviations

Acronym	Description
ARI	Annual recurrence interval
AWM	Albert Water Management
CNOOC	China National Offshore Oil Corporation
CPF	Central Processing Facility
DEM	Digital Elevation Model
DO	Dissolved Oxygen
DRC	Democratic Republic of Congo
DWRM	Directorate of Water Resources Management
EA	Exploration Areas
EBS	Environmental Baseline Study
EC	Electrical Conductivity
EFOs	Environmental Field Officers
EHS	Environmental, Health, and Safety
EIA	Environmental Impact Assessment
EIS	Environmental Impact Statement
EMP	Environmental Management Plan
EPH	Extractable Petroleum Hydrocarbons
ESIA	Environmental and Social Impact Assessment
ESIS	Environmental and Social Impact Statement
ESMP	Environmental and Social Management Plan
GRO	Gasoline Range Organics
IFC	International Finance Corporation
IPIECA	International Petroleum Industry Environment and Conservation Association
KF	Kingfisher
NEMA	National Environment Management Authority
PAH	Polyaromatic Hydrocarbons
POC	Potentially oil contaminated
SOW	Scope of Work
SPT	Sewage treatment plant
SW	Surface Water
TDS	Total Dissolved Solids
WHO	World Health Organization
WRMD	Water Resource Management Directorate





Table of Contents

1.0 INTRODUCTION	1
2.0 SCOPE OF WORK.....	1
3.0 METHODOLOGY	1
3.1 Documentation review	1
3.2 Field investigations	1
4.0 PROJECT SUMMARY	2
4.1 CPF, wells flowlines and associated infrastructure	2
4.2 Feeder pipeline	2
5.0 BASELINE INVESTIGATION	5
5.1 Objectives of Baseline investigation	5
5.2 Regional Setting.....	5
5.2.1 Climate	5
5.2.1.1 Historic climate	5
5.2.2 Rainfall	6
5.2.3 Evaporation	7
5.2.3.1 Climate change.....	7
5.2.4 Topography	9
5.2.5 Regional description	11
5.3 Hydrological description.....	13
5.3.1 System overview	13
5.3.2 Lake Albert	16
5.3.3 Conceptual hydrological understanding	17
5.3.4 Water quality	20
5.3.5 <i>In situ</i> Water Quality.....	23
5.3.6 Water Quality Analysis.....	24
5.3.6.1 Results and Discussion	26
5.4 Hydrological modelling.....	30
5.4.1 Peak calculation	30
5.4.2 Floodlines	32
6.0 IMPACT ASSESSMENT	35





6.1	Major areas of concern for surface water impacts	35
6.1.1	Camps (temporary and permanent)	35
6.1.2	Well pads.....	35
6.1.3	Central Processing Facility	37
6.1.4	Pipelines.....	48
6.2	Impact Assessment Methodology.....	49
6.3	Construction and decommissioning phase impacts	51
6.3.1	Increased erosion and runoff volumes	52
6.3.2	Increased dust and sedimentation in drainage streams.....	54
6.3.3	Altering the banks and beds of streams due to excavation for infield and export pipelines	54
6.3.4	Spillage of oils, fuel and chemicals polluting water resources	55
6.3.5	Discharge of poor quality effluent from the sewage works at the temporary camp	56
6.4	Operational phase.....	57
6.4.1	Catchment reduction	58
6.4.2	Erosion, dust and sediment collection	59
6.4.3	Discharge of poor quality storm water	59
6.4.4	Crude oil spills.....	60
6.4.5	Infrastructure crossing natural drainage lines	62
6.4.6	Oil leaks along the pipeline	62
6.4.7	Rise in water level of Lake Albert	63
6.4.8	Impact on Lake Albert volume due to abstraction for the project.....	63
6.4.9	Discharge of poor quality effluent from the sewage works.....	64
7.0	RECOMMENDED MITIGATION MEASURES	65
7.1	Construction.....	65
7.1.1.1	Sewage management.....	66
7.1.1.2	Storm water management.....	67
7.1.1.3	Process water management.....	68
7.2	Operational phase.....	69
7.2.1.1	Sewage water management.....	70
7.2.1.2	Storm water management plan	70
7.2.1.3	Process water management.....	72
8.0	REFERENCES	73





TABLES

Table 1: Comparison of Calculated 24 hour ARI Peak Rainfall depths	7
Table 2: Monthly Evaporation for Masindi Town (UNDP and WMO, 1974).....	7
Table 3: Surface water quality monitoring points for the Kingfisher Development Area	20
Table 4: Flow rates measured at four (4) surface water monitoring stations on 20 March 2014	23
Table 5: Surface water in situ measurements for selected sites (December 2013).....	23
Table 6: Sampled sites in nearshore waters of Lake Albert along Kingfisher flats (aquatic biodiversity survey led by Dr T Kairania).....	24
Table 7: Baseline surface water monitoring results for the dry season (March 2014)	27
Table 8: Water quality data for samples taken at sites in nearshore waters along Kingfisher Flats, Lake Albert (May 2014).....	29
Table 9: Catchment properties used in the Rational method.....	30
Table 10: 50 year and 100 year Peak flows calculated using the Rational Method.....	30
Table 11: Properties of CNOOC produced water.....	40
Table 12: Specification for injection of produced water	41
Table 13: Determination of impact severity	50
Table 14: Impact assessment criteria and rating scale.....	50
Table 15: Potential impacts in the construction and decommissioning phase	51
Table 16: Treated sewage effluent discharge limits (EFC standards).....	57
Table 17: Potential impacts related to the Operational phase	57
Table 18: Variables to be measured for surface water	61
Table 19: Conceptual water balance over Lake Albert	64
Table 20: Surface Water Impacts during Construction Phase	65
Table 21: Indicative Values for Treated Sanitary Sewage Discharges (International Finance Corporation, 2007).....	67
Table 22: Emissions, Effluent and Waste Levels from Onshore Oil and Gas Development (International Finance Corporation, 2007).....	68
Table 23: Surface Water Impacts during Operation Phase	69
Table 24: Total Runoff Volumes Expected in Potentially Contaminated Areas for the 1 in 2, 10, 20, 50 and 100 year 24 hour Storm Events.....	71

FIGURES

Figure 1: Project infrastructure to be developed on the Buhuka Flats.....	3
Figure 2: Project site location and feeder pipeline route.....	4
Figure 3: Rainfall data – Uganda (The World Bank Group, 2017).....	5
Figure 4: Rainfall distribution over the Lake Albert Basin (WSS Services (U) Ltd, 2012).....	6
Figure 5: Projected change in rainfall based on the CGCM3 model for the period 2020 to 2039.....	8
Figure 6: Days of extreme rainfall.....	8
Figure 7: Regional land uses map indicating drainage lines and wetlands within the regional study area of the Kingfisher Development	10





Figure 8: Location of the Kingfisher Development Area within the exploration area.....	12
Figure 9: Site layout map.....	13
Figure 10: Regional water management zones for the site	15
Figure 11: Lake Albert surface water elevation at Butiaba	16
Figure 12: Wave erosion occurring on the shoreline of the Flats	17
Figure 13: Hydrological Conceptual Model	17
Figure 14: River bed material	19
Figure 15: Interflow interception due to soil compaction.....	19
Figure 16: Gullies observed on the escarpment and plain.....	19
Figure 17: Wetland.....	19
Figure 18: Surface water quality sample sites	22
Figure 19: Lake Albert water quality sites (aquatic biodiversity survey led by Dr T Kairania, May 2014).....	25
Figure 20: Site specific catchments.....	31
Figure 21: 1 in 50 and 1 in 100 year flood lines for the Flats.....	33
Figure 22: 1:100 floodlines along the pipeline routing	34
Figure 23: Proposed infrastructure in relation to preferential flow paths	35
Figure 24: CPF and associated infrastructure.....	39
Figure 25: Produced water injection (including make-up water).....	42
Figure 26: Typical API oil separator (Source: API, 1990)	44
Figure 27: Handling of clean and POC water at the CPF	45
Figure 28: KDA drainage to the lake	46
Figure 29: Northern drainage	47
Figure 30: CPF hydrograph	47
Figure 31: Schematic of sewage treatment capacity for the CPF, supply base and permanent camp	48
Figure 32: Schematic of production and water injection flowlines	48
Figure 33: Cross section of a flowline crossing of a typical drainage line	49
Figure 34: Likely drainage path to the Papyrus Lagoon	53

APPENDICES

APPENDIX A

Constants used in the Rational method for the calculation of flood lines

APPENDIX B

Results obtained from initial water quality sampling run

APPENDIX C

Results obtained from second water quality sampling run





1.0 INTRODUCTION

Golder Associates Africa (Pty) Ltd. (hereafter 'Golder') was contracted by China National Offshore Oil Corporation (hereafter 'CNOOC') to conduct a baseline assessment of the surface water hydrology associated with the proposed well field development for Kingfisher, Hoima District in Uganda. The assessment was conducted as a technical study to inform the Environmental and Social Impact Assessment (ESIA) being conducted by Golder for the Kingfisher Development Area.

This report presents the hydrology baseline and impact assessment for the Project. An understanding of baseline hydrological conditions prior to oil and gas development is essential to assess changes in water availability that could affect local users. Changes in hydrology can also affect water quality and other resources such as fish habitat, vegetation and wildlife. Hydrological data is further required to design oil and gas facilities including culverts, channels and storage ponds.

2.0 SCOPE OF WORK

The baseline and impact assessment components of surface water address the following aspects:

- Description of the annual and seasonal climatic regimes using parameters such as mean annual temperature, mean monthly rainfall, annual and monthly evaporation for the study area based on regional and local climatic data;
- Development of a surface water monitoring network;
- Management of baseline monitoring data;
- Development of stage-discharge curves;
- Description of the annual and seasonal surface water regimes for the study area based on monitoring data;
- Management of water quality monitoring data; and
- Description of water quality monitoring data and analysis.

3.0 METHODOLOGY

3.1 Documentation review

Available reports and studies supplied by the client as well as those found as part of a literature survey were used to provide a description of the baseline. A comprehensive reference list can be found in section 8.0.

3.2 Field investigations

In December 2013 the following monitoring procedure was set up:

- During site visits, general observations in terms of the site condition should be made and recorded. The observations included changes in channel form at the gauge cross-section, and upstream and downstream conditions. Observations also included vegetation changes. The extent of vegetation and channel sedimentation/erosion was noted. All changes between site visits resulting from catchment development and/or local activities were recorded;
- Flow measurement must be performed consistently in the same way, according to the Golder flow measurement procedure supplied to the monitoring team;
- Sampling of surface water must be done at key locations within the study area;
- It is crucial that measured monitoring data is processed and checked on the same day, so that any errors can be identified to prevent loss of monitoring data; and
- Training on surface water monitoring data collection was provided to the monitoring team.



4.0 PROJECT SUMMARY

4.1 CPF, wells flowlines and associated infrastructure

Wells, The Kingfisher development is an upstream project comprising wells, flow lines, central processing facility (CPF) and associated infrastructure and an oil product line, the feeder pipeline, to distribute oil to the tie in point with the export pipeline at Kabaale. This infrastructure is summarised in more detail below.

The wells, flowlines, central processing facility (CPF) and supporting infrastructure are situated on the Buhuka Flats in the Kingfisher Development Area (KFDA), on the south-eastern shores of Lake Albert. The project entails the drilling of wells from four onshore well pads, namely Pad 1, Pad 2, and Pad 3 (where exploration wells have already been drilled) together with Pad 4A (where no drilling has yet taken place). A total of 31 wells are planned to be drilled and commissioned as part of the development, 20 of which will be production wells and 11 to be used as water reinjection wells.

The produced well fluids will be conveyed to the CPF through buried infield flow lines connecting each well pad to the CPF. Well fluids will be separated at the CPF to yield produced water, sand, salts and associated gas (together with small quantities of other material) and crude oil of a quality that will meet the crude oil export standard. At the CPF the associated gas will be utilised for production of power or LPG for local market. Power will serve the requirements of the Kingfisher development but in later years is likely to be in excess of project requirements and will be exported to the national grid. No gas flaring is contemplated except in cases of emergency.

Supporting infrastructure associated with the production facility will include in-field access roads and flowlines, a jetty, and a water abstraction station on Lake Albert, a permanent camp, a material yard (or 'supply base'), and a safety check station at the top of the escarpment (Figure 1).

4.2 Feeder pipeline

A feeder pipeline exits from the CPF and extends to the north running from the CPF storage tanks to a delivery point near Kabaale. The feeder pipeline exits the CPF on the east side, running almost due north to the base of the escarpment, where the alignment turns to the East climbing the escarpment. The average gradient in this section of the route is 1:3 (Vertical: Horizontal), rising from roughly 650 to 1040 mamsl. within a horizontal distance of 740 m. From the point at which the feeder pipeline crests the escarpment, the pipeline route runs to the north-east through gently undulating terrain that is extensively cultivated. This landscape includes a number of rural settlements. The route passes south-east of Hohwa and Kaseeta villages and passes immediately north of the planned Kabaale Airport, turning eastward to the terminal point at the proposed Kabaale Refinery. The total length of the pipeline is 46.2 km.

At Kabaale, the Government of Uganda is planning an industrial park which, among other facilities, will include a refinery, associated petrochemical processing plants, an international airport and related supporting infrastructure.

At the delivery point, there will be metering of the crude oil, which will be piped either to the industrial park to feed the refinery and associated petrochemical industry or exported through the East African Crude Oil Pipeline (EACOP), planned from Kabaale to the Tanga sea port in Tanzania. The EACOP will be a public - private partnership between the governments of Uganda, Tanzania and oil company(s).

The Feeder Pipeline ends at the delivery point in Kabaale. The industrial park and the EACOP are independent projects that do not feature further in the FD-ESMP (Figure 2).



Figure 1: Project infrastructure to be developed on the Buhuka Flats





SURFACE WATER SPECIALIST REPORT

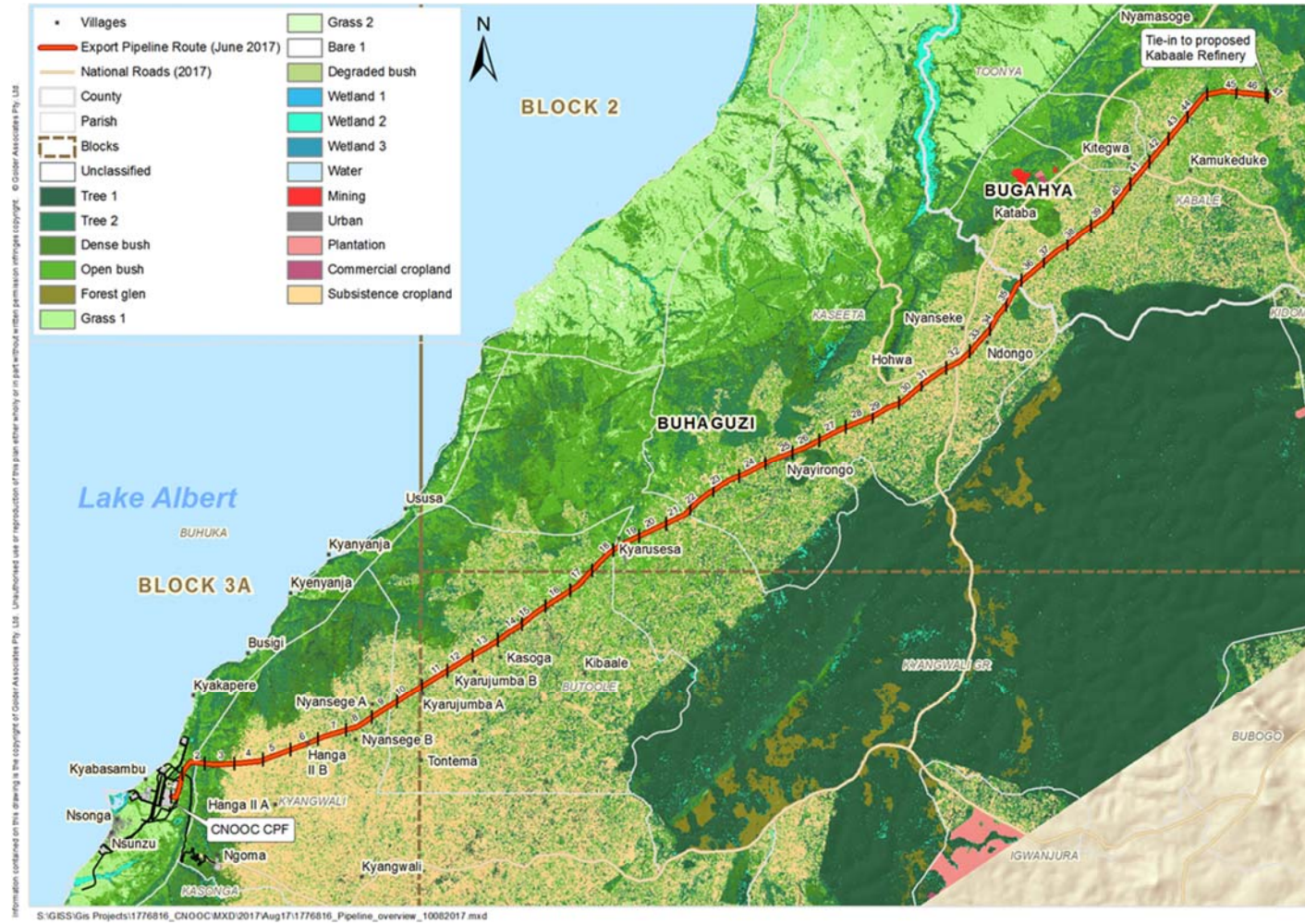

Figure 2: Project site location and feeder pipeline route

October 2017

Report No. 1776816-321512-13





5.0 BASELINE INVESTIGATION

5.1 Objectives of Baseline investigation

The key objective of the baseline surface water investigation was to provide a description of the current hydrological conditions on site. This was achieved by:

- Collating available information in terms of meteorological and hydrological data;
- Setting up a hydrological monitoring network to collect information on baseline flows and water quality; and
- Describing flow patterns in the affected catchments in order to assess the potential impact the drilling could have on the catchment.

5.2 Regional Setting

5.2.1 Climate

5.2.1.1 Historic climate

The Köppen Climate Classification system was used to determine the regional climate for Uganda. The classification divides type of climates into different groups and sub-groups. The study area falls within the Aw group in the classification system. The regional climate is thus described as tropical with a distinct wet and dry season. The dry season coincides with the summer months with higher temperatures as presented in Figure 3. Temperature differentials are minimal in the area with average temperatures ranging from 22.4°C to 25.6°C. A mean annual rainfall of approximately 1 140 mm was recorded between 1991 and 2015.

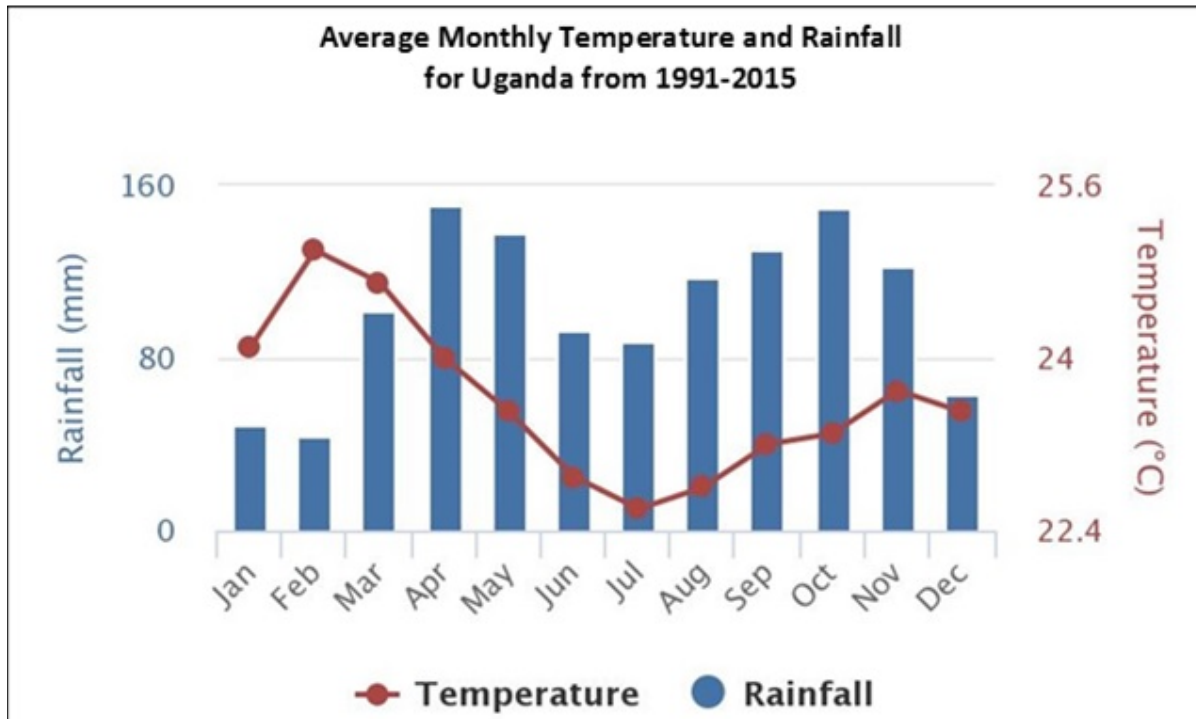

Figure 3: Rainfall data – Uganda (The World Bank Group, 2017)





The peak rainfall periods are between March-May and August-November. In general, the second peak rainfall (August to November) is higher than the early peak. The rainfall and in turn river runoff is important for agricultural development. Western areas bordering the rift valley are the driest and hottest.

5.2.2 Rainfall

Rainfall over Lake Albert catchment is lowest over the Lake (700 mm), gradually increasing outwards towards the escarpments on both sides to over 1 400 mm (Savimaxx Limited, 2006) as shown in Figure 4. The escarpment is likely creating an orographic effect, whereby rainfall increases due to the convection of air as altitude increases.

Rainfall over the Lake is approximately 700 mm/a and gradually increases towards the escarpments to 1 400 mm/a.

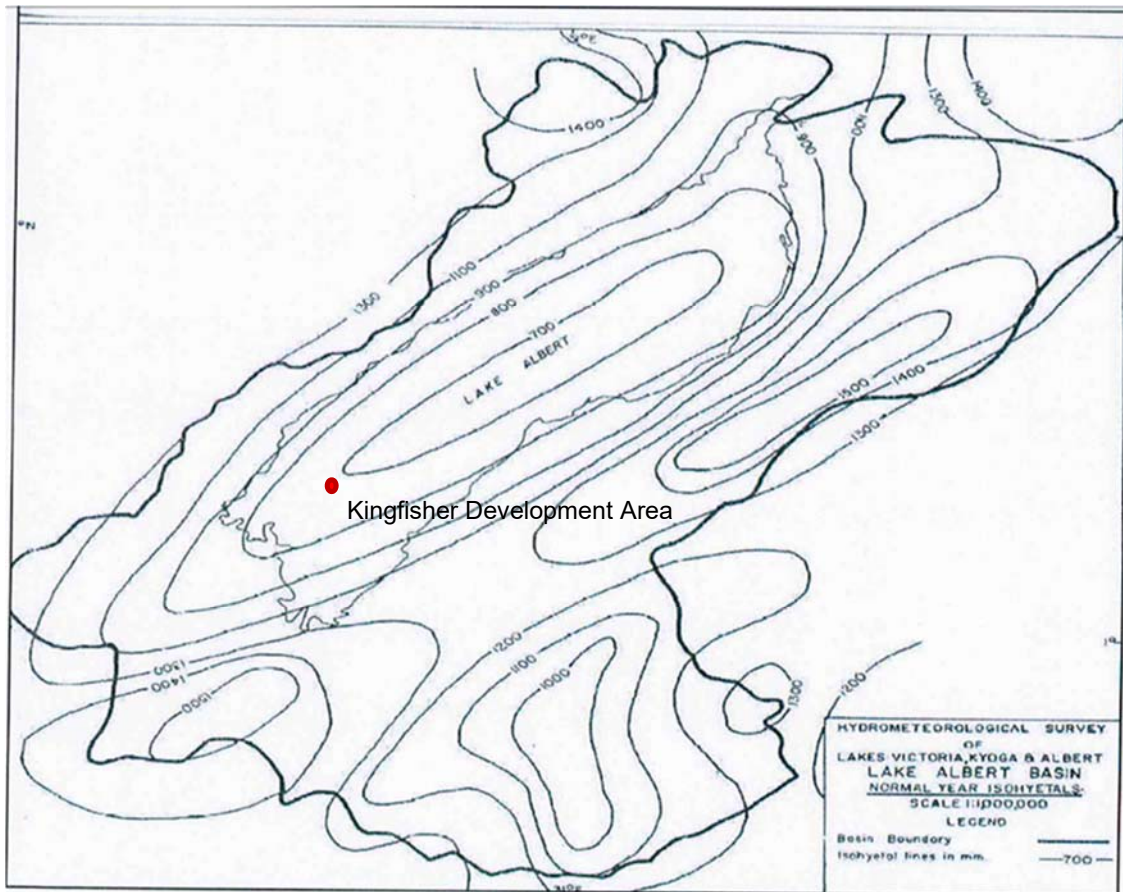

Figure 4: Rainfall distribution over the Lake Albert Basin (WSS Services (U) Ltd, 2012)

Rainfall data for the actual site was not available. Two rainfall stations were set up, one on the Flats and one on the escarpment to monitor the difference in rainfall regimes.

Rainfall data was obtained from neighbouring towns and existing reports and studies on predicting east African storms. The peak design storm that was used in the floodlines and baseline modelling is also presented in this section.

Design rainfall was calculated using a method reported in The Prediction of Storm Rainfall in East Africa, Fiddes et al (1974). According to the report, for much of East Africa a station on or close to a study area cannot be found or if available often has limited records that would give unreliable estimates of rainfall



peaks. In order to address this limitation all available published records were analysed to produce maps of storm rainfall from which individual catchments could be interpolated.

The Karira network was selected as the closest representative rainfall region for the study. The mean regression equation for the network was applied.

Mean equation $Y = 53.06 t + 13.95 X$

Y = Maximum expected daily point rainfall in T years (mm)

X = $-(0.834 + 2.303 \log \log T)$ where T is the return frequency (yrs)

For comparative purposes, rainfall data was extracted from the KNMI Climate Explorer webpage. The closest town with available rainfall data was Masindi which is 87.5 km away from the CNOOC Kingfisher Development Area. The Masindi rainfall data record is 59 years in length, with 647 days of missing data. The maximum 24 hour rainfall depths each year were calculated and a statistical projection was plotted to calculate the various return period design rainfall depths. The Log Pearson 3 and Log Extreme value type 1 distribution were well suited to the data. A comparison between the design rainfall depths extrapolated from these two distributions and the interpolated rainfall depth from the east Africa report is shown in Table 1.

Table 1: Comparison of Calculated 24 hour ARI Peak Rainfall depths

Return Periods	Log extreme value type 1 distribution from KNMI data	Interpolated from Design storms in East Africa
1 in 2	57	58
1 in 5	-	74
1 in 10	81	84
1 in 20	92	94
1 in 50	109	107
1 in 100	124	117
1 in 200	141	162

The length of the Masindi rainfall record is relatively short for calculations of extreme events such as the 1 in 200 year design storm. This can be seen by the difference in the extreme event depths produced using different methods.

5.2.3 Evaporation

The site area does not have long-term potential evaporation records. The Lake evaporation was taken from the hydro meteorological survey of the Lake’s catchments report and is presented in Table 2.

Table 2: Monthly Evaporation for Masindi Town (UNDP and WMO, 1974)

	Date Period	Jan	Feb	Mar	Apr	May	Jun	Jul	Aug	Sept	Oct	Nov	Dec
Monthly evaporation (mm)	1962-1968	149	135	146	128	137	121	116	117	127	131	119	131

5.2.3.1 Climate change

Several studies have indicated that Uganda is vulnerable to climate change. Climate change impacts can result in significant changes to water management measures. For this reason, a high level climate change





overview was included in this report. The CGCM3.1 Model presented on the Climate Change Portal (The World Bank Group, 2017) was used for the discussion.

Results indicate that Uganda is likely to experience more extreme periods of intense rainfall, an erratic onset and cessation of the rainy seasons and more frequent episodes of drought. (Global Climate Change Alliance, 2012).

Monthly Rainfall

The CGCM3.1 model predicts an increase in monthly rainfall averages with an increase of up to 30 mm in November as presented in Figure 5. A decrease of 1.5 mm was noted for August. An overall increase of approximately 180 mm per annum is predicted. This will result in a mean annual rainfall of 1 320 mm.

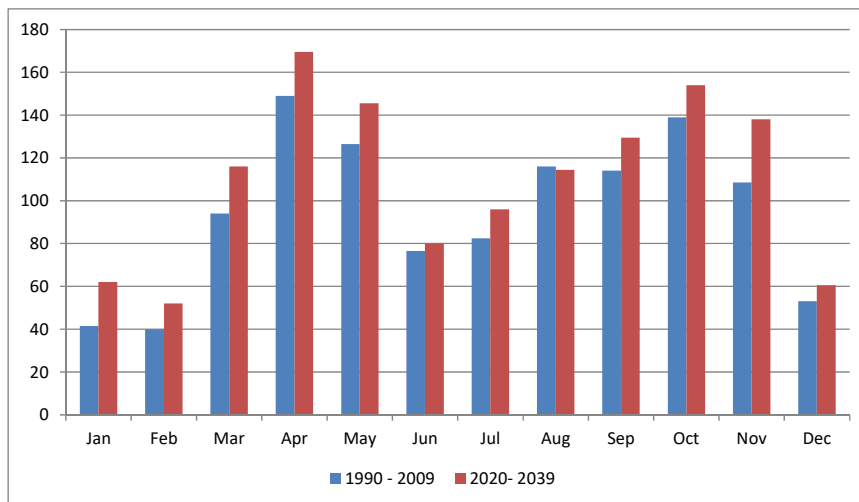

Figure 5: Projected change in rainfall based on the CGCM3 model for the period 2020 to 2039

An increase in rainfall intensity is also anticipated. Figure 6 presents the number of days with extreme rainfall predicted as compared to the historical data available.

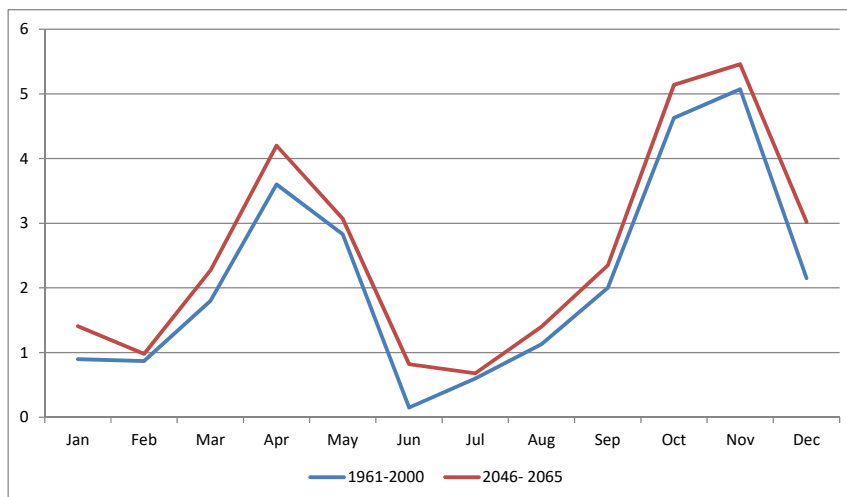

Figure 6: Days of extreme rainfall





5.2.4 Topography

The Lake Albert catchment falls within the Western Rift Valley. The landscape ranges from the low-lying Rift Valley floor to the rift escarpment and the raised hill ranges. The topography of Hoima District is part of a divided central African surface characterized by broad, flat-topped ridges of about 1 000 to 1 100 meters in height, whose formation is given as upper *Cretaceous* (65 - 135 million years ago). The surface rises to a plateau, which ranges between 600 - 800 metres above sea level. The topography around the edge of the Lake ranges from the broad plateau further inland, dipping down abruptly to the low-lying lake's edge which is flat and characterized by wetlands and intertwining rivers (International Lake Environment Committee Foundation, 1999).

The Kingfisher Development Area is located in an area that is commonly known as the Buhuka Flats in the Hoima District. Figure 7 shows the drainage lines of the Kingfisher Development Area, as well as the wetland delineation and the multiple rivers that flow over the sunken Flats on which the project is situated.

The water system drains northwards from the site. Lake Albert and its surrounding catchment form part of the source of the Nile. The main sources of water that feed Lake Albert are the Semliki River and the Victoria Nile. The Semliki River enters Lake Albert in the southern tip and drains from Lake Edward. The Victoria Nile enters into Lake Albert at the north, next to the outflowing point of Albert Nile. The Victoria Nile drains Lake Kyoga which in turn is fed from Lake Victoria, which is the largest fresh water Lake in Africa. The Victoria Nile regulates the levels in Lake Albert, but because it does not enter lower down in the Lake, it does not influence the salinity or ecology. Lake Albert is a saline Lake with a pH of approximately 9 (International Lake Environment Committee Foundation, 1999). There are other smaller rivers that enter into the Lake from Uganda and the DRC shores, some of these are highly seasonal and of little importance to the hydrology of the Lake.

Much of Hoima District is occupied by sedimentary beds of the Bunyoro geological series mainly represented by tillites and phyllites with subsidiary amounts of sandstones and conglomerates as basal members. These rocks are generally classified under Precambrian era, which are part of the dissected African surface.



SURFACE WATER SPECIALIST REPORT

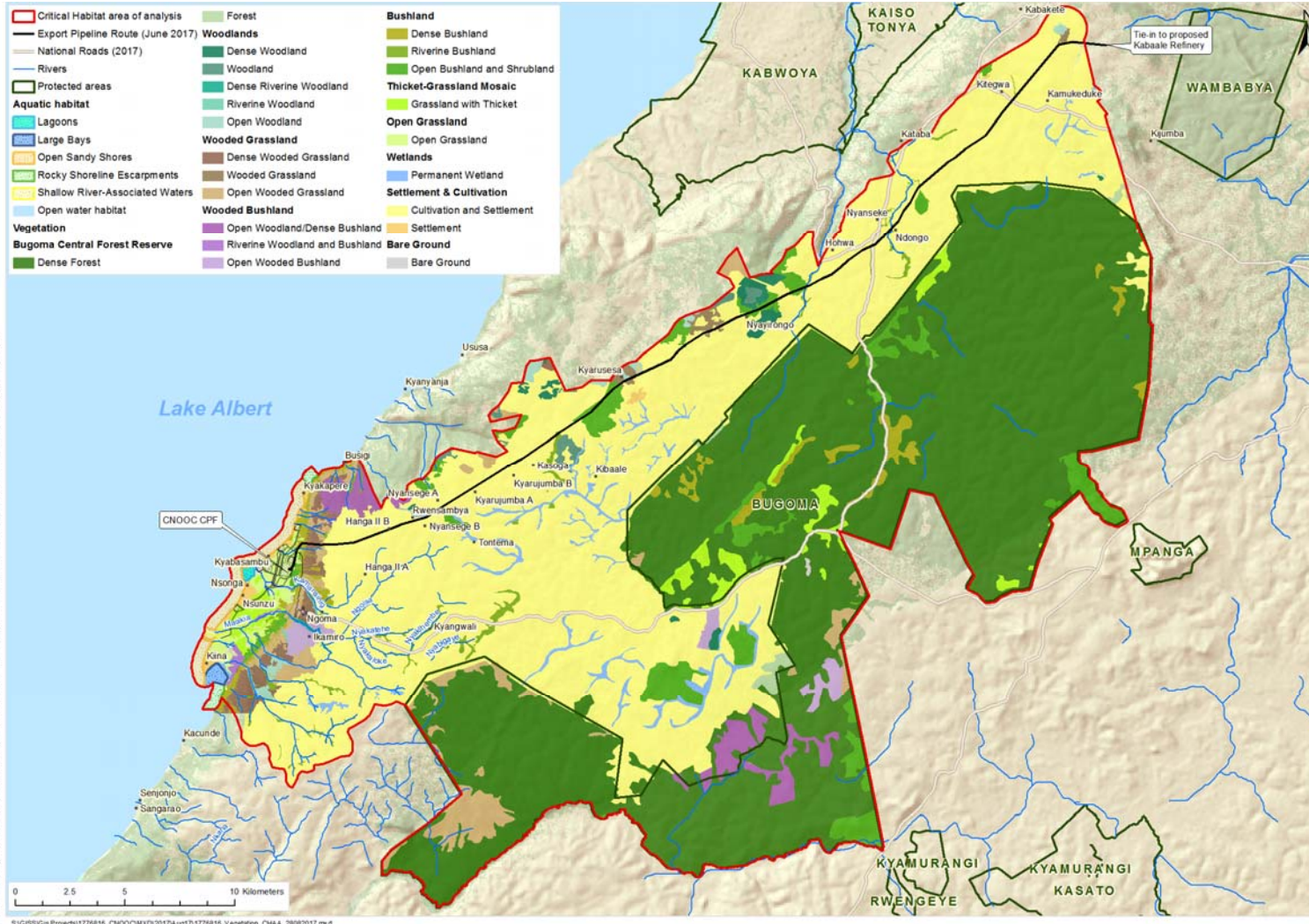

Figure 7: Regional land uses map indicating drainage lines and wetlands within the regional study area of the Kingfisher Development





5.2.5 Regional description

The proposed oil and gas well-field site is located on the eastern border of Lake Albert shores, in Uganda, in the Hoima District. Lake Albert forms a border between the Democratic Republic of Congo and Uganda. The Kingfisher Development Area is situated within exploration area block 3A. Figure 9 illustrates the site location in relation to the lake.

Figure 8 indicates the location of the Kingfisher Development Area within the exploration area block 3A and surroundings and the tie-in to the proposed Kabaale Refinery.

The Albertine Graben region stretches from Sudan in the north to Lake Edward in the south. The Lake Albert region is remote, land-locked and approximately 1 200 km from the nearest sea port. The region has rich biodiversity and significant surface water resources. The rivers and streams originate on the high elevated areas of the escarpment, flow down the escarpment into the valley and drain into Lake Albert. A series of erosion valleys and gullies cut the escarpment and discharge runoff from the escarpment to the valley.

The seasonal streams and rivers are flooded by runoff from the catchment areas after heavy rainfall events. The water drains quickly into Lake Albert and the discharge in the run-off channels ceases. The perennial rivers (Hohwa and Wambabya) flow continuously with peak flow during the rainy season.

All of Uganda drains towards the Nile. Most of the rivers originating on the highlands surrounding this area drain into the Lakes which in turn, drain into the Nile via Lake Albert. The River Semliki, which drains from Lake Edward is the most significant of these rivers (Uganda National Environmental Management Authority, 2010).

Water Use

Lake Albert is used mainly for fishing and tourist industries, with a high number of the protected areas being in the Albertine Rift and specifically in the area around Lake Albert. A number of people live in fishing villages on the shores of lakes Albert, Edward and George with fisheries activities providing an important source of livelihoods for the people in the Albertine Graben. The region contributes 18.7% of the total national fish catch, of which 15% is contributed by Lake Albert. Fish processing has become an important activity on the lake, both at artisanal and industrial level (NEMA, 2008). In terms of the fish biodiversity Lake Albert is the richest of the lakes in the region having approximately 53 fish species, about ten of which are endemic.

The local communities choose to use water from rivers and streams for agricultural purposes as the soils on the rift valley floor are predominantly sandy, making the area moisture deficient and unsuitable for agriculture. The clay soils in the Semliki flats are saline which also limits their agricultural potential. Therefore, the largest proportion of the rift valley area is of low agricultural potential, partly explaining its conservation area status.

The main settlements are sparse and rural with the majority of inhabitants being indigenous pastoral communities whose livelihoods depend on cattle. They include the Batuku in the Semliki flats and Basongora in Kasese to the south-west. The main towns in the area include Masindi, Hoima, Fort Portal, Hima and Kasese-Kilembe. Urbanization is taking place along the road system in the region and is likely to intensify due to the oil production activities in the region, which may pose new challenges of environmental management and development.

There is a small pocket of water called Luzira (RS03 in the Cultural Heritage Impact Assessment Report) that is a body of water with significant cultural features and is located near the Lake shore, about 200 m from the Jetty. For more information on this feature, please refer to the Cultural Heritage report. Lake Albert is the seventh largest in Africa, with a surface area of 5 300 km². The Lake surface has an elevation of 615 masl and its' deepest point is 58 m, with a median depth of 25 m. The water level fluctuations in the past have been recorded as an annual change of 0.5 m, but this range of fluctuation has increased due to climate change and the levels rising in Lake Albert (International Lake Environment Committee Foundation, 1999).





SURFACE WATER SPECIALIST REPORT

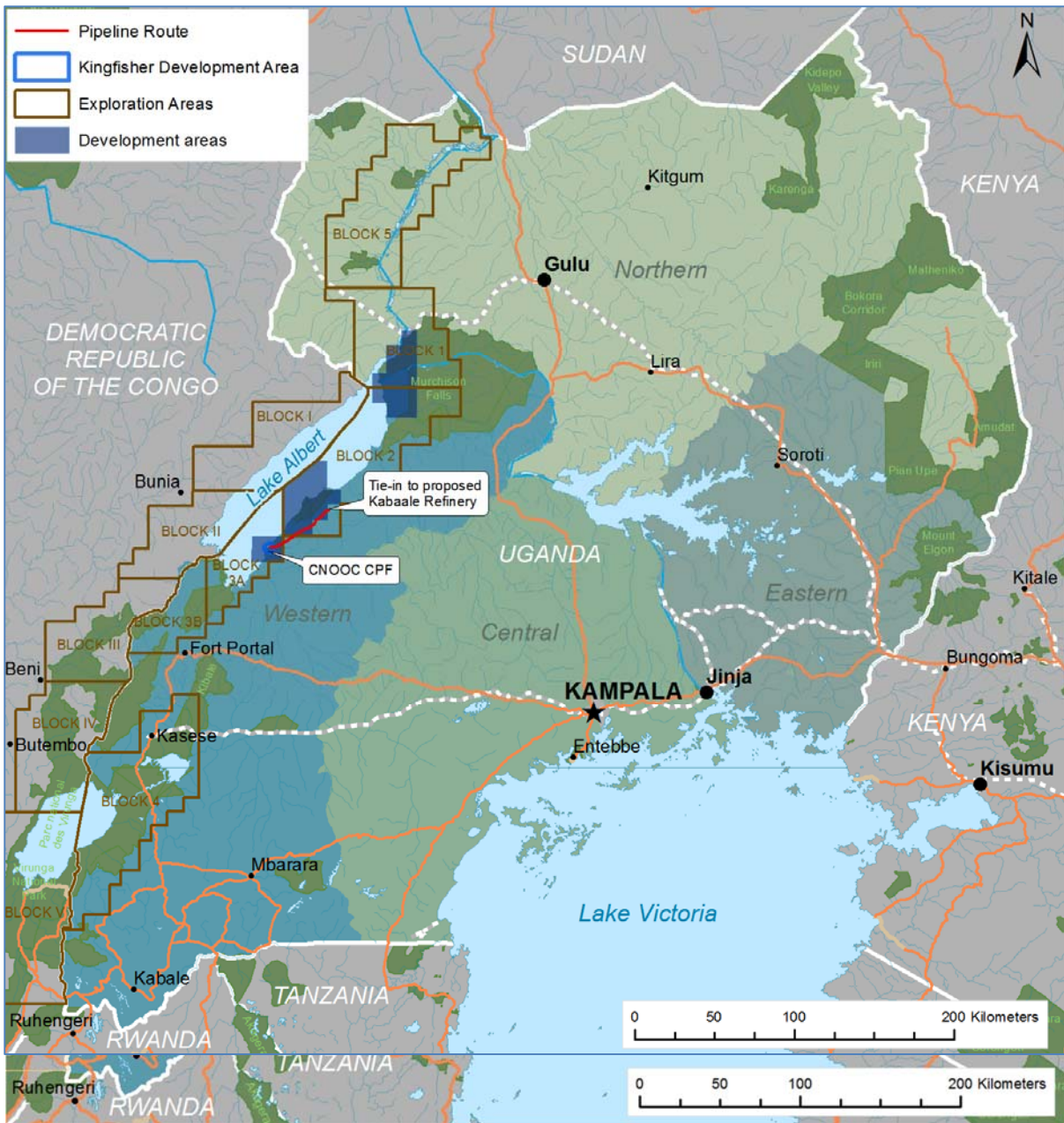

Figure 8: Location of the Kingfisher Development Area within the exploration area





Figure 9: Site layout map

5.3 Hydrological description

5.3.1 System overview

The project area regionally forms part of the Hoima District, a Ugandan District that is bordered by Lake Albert in the west, Bundibugyo and Kibaale Districts in the south, Masindi District in the northeast and Kiboga District in the east. It is also hydrologically located within the Albert Water Management (AWM) Zone (Figure 10).

The AWM Zone is made up of catchments discharging into Lake Edward and Lake George; and catchments downstream of Lake Edward discharging into Lake Albert. Lake Albert occupies the majority of the approximately 2 270 km² area of the District covered by water bodies¹. The Rivers Howa, Wambabya, Hoima and Waki all drain into Lake Albert. Hoima has substantial surface water resources which account for about 38% of the total area of the District.

In the western fringes of Lake Albert Basin lies the Western Rift Valley, an area that is largely covered by the Semliki Flats, Lake Albert and the Escarpment (NEMA, 1996). Road construction to the Lakeshores in Hoima District (project district) is reported to remain a big challenge due to the rift valley terrain.

Local Context

Hydrologically, the project site is located within the Kingfisher Development Area catchment and drains westwards into the south eastern embankments of Lake Albert. Kingfisher Development Area catchment is associated with a very high western rift escarpment that drains into Lake Albert via several scattered streams

¹ Other water bodies in the district include River Kafu which forms a boundary with Kibaale District and drains into Lake Kyoga (Kyoga WM Zone), east of Albert WM Zone.





and wetlands flowing westwards. Streams within the project zone of influence include the Kamansinig and Masika Rivers.

The Kamansinig River flows south west from above the escarpment, drains north west over the escarpment and then passes just south adjacent to where the majority of the proposed project infrastructure will be located below the escarpment into Lake Albert. The Masika River drains its tributaries, the Ngoisa, Nyakatehe and an unnamed tributary, also from above the escarpment. The Masika River drains then flows south west between Pad 3 and 5 into Lake Albert below the escarpment. Various other streams also flow over the escarpment and either join the main Rivers mentioned above (such as Masika) or gradually and independently feed Lake Albert.

The area below the escarpment is approximately 13 km² and, besides the rivers mentioned, is characterised by relatively scattered wetlands at an elevation level associated with most project infrastructure (628 mamsl). These plains, because of their close relationship with Lake Albert, may have significant water quality implications (see section 5.3.4).



SURFACE WATER SPECIALIST REPORT

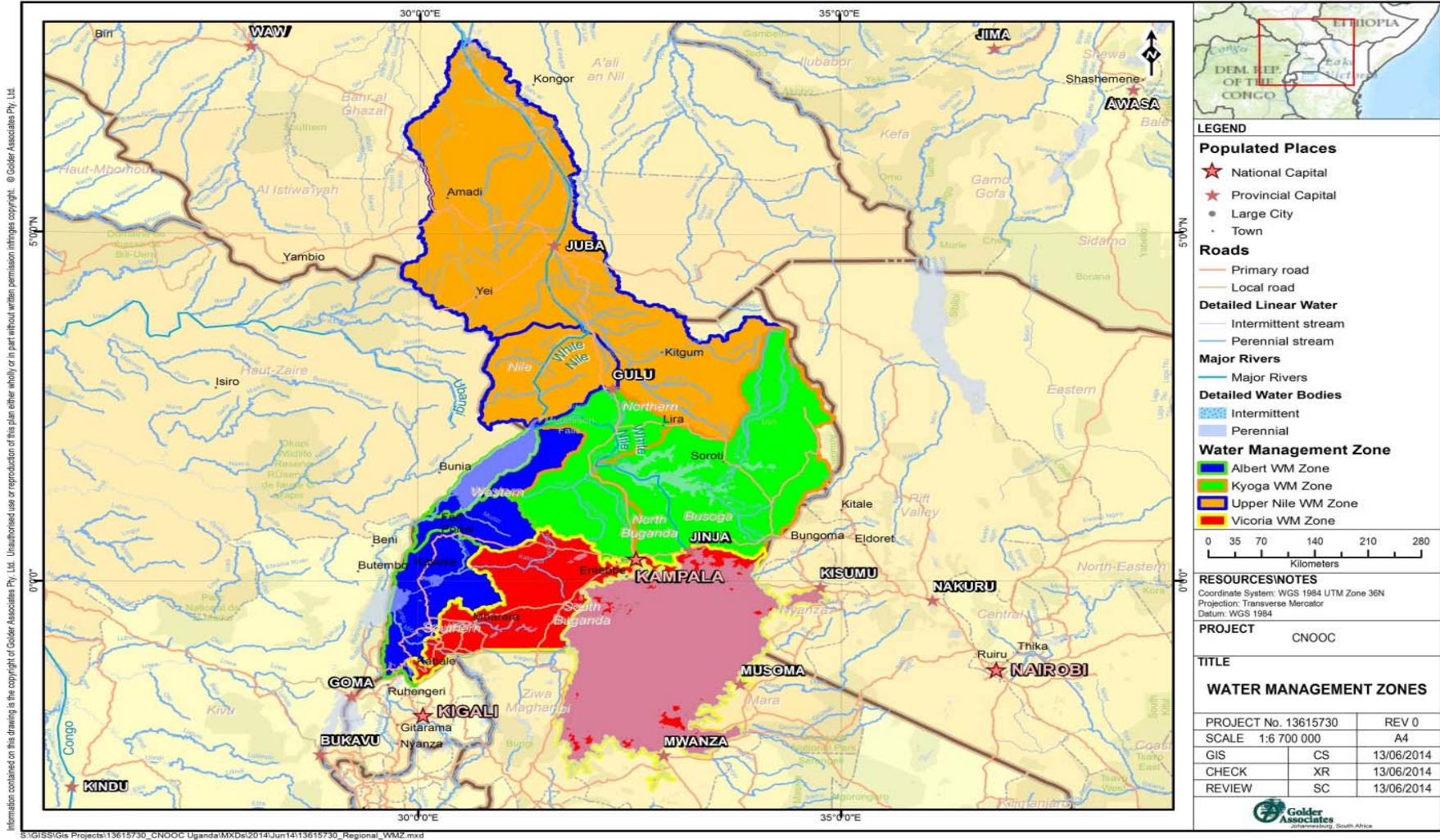

Figure 10: Regional water management zones for the site





5.3.2 Lake Albert

Lake Albert lies between two parallel escarpments in the Western Rift Valley.

Lake Albert covers a surface area of approximately 5 300 km². The Lake is approximately 150 km long, with an average width of 35 km and a maximum depth of 56 m. The principle influent streams to the Lake are the Semliki and Victoria Nile (Ramsar, 1992) (International Lake Environmental Committee, n.d.).

Lake Albert has a catchment area of 18 223 km² and includes Semliki, Muzizi and the west-ward flowing component of Kufu. The Semliki and Victoria Nile inflows account for approximately 83 % of the total inflow to the Lake, direct rainfall, approximately 10 % and inflow from local catchments account for the remaining 7 %. Evaporation accounts for approximately 26 % of the outflow from the Lake and the Albert Nile is the largest output (WSS Services (U) Ltd, 2012).

Rainfall over the Lake is approximately 700 mm/a and gradually increases towards the escarpments to 1 400 mm/a. Water levels at Butiaba on Lake Albert (approximately 90km north of the project site) have been recorded since January 1948. Analysis of the records shows annual variations of approximately 4 m. The monthly variations are shown in Figure 11.

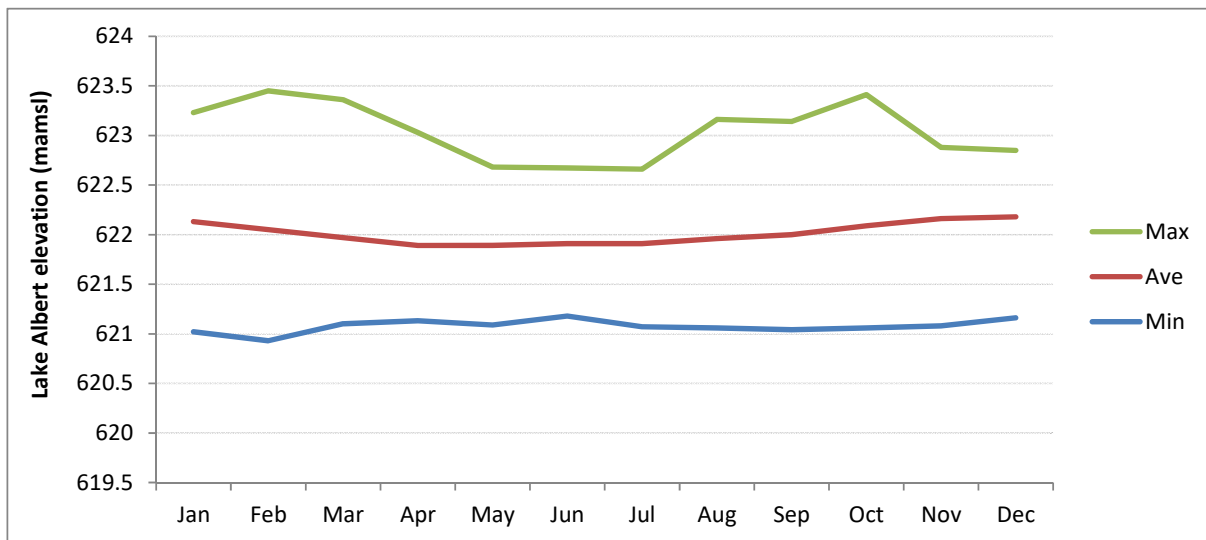

Figure 11: Lake Albert surface water elevation at Butiaba

It is to be noted that the surface water elevation trends do not depend solely on the hydrology of the Lake. It is also dependent on the dam release operations and the wind waves. Wind blowing over the calm Lake surface produces an effect that may appear as a widely varying and fluctuating ruffling of the surface. These small wind-induced waves can be observed at the Flats. These are quite transient, dissipating rapidly if the wind dies away. However due to the extent of the Lake it is also likely that more persistent gravity waves affect the water level. It is likely that a difference of several metres can be observed at different location on the Lake. A water level logger was installed on the Flats to monitor the more localised water level of Lake Albert.

The impact of these naturally occurring waves on the geomorphology of the Flats is noticeable as shown in Figure 12. At several locations along the Flats shoreline, the soil is being exposed as waves erode the shoreline. This is a naturally occurring process and it is being compensated to some extent by the rate of sediment material transported from the Flats upstream catchments and discharged into Lake Albert.





Figure 12: Wave erosion occurring on the shoreline of the Flats

5.3.3 Conceptual hydrological understanding

The water system of the Flats is very different from the rest of its upstream catchment. A conceptual model of the Flats' hydrological system is presented in Figure 13.

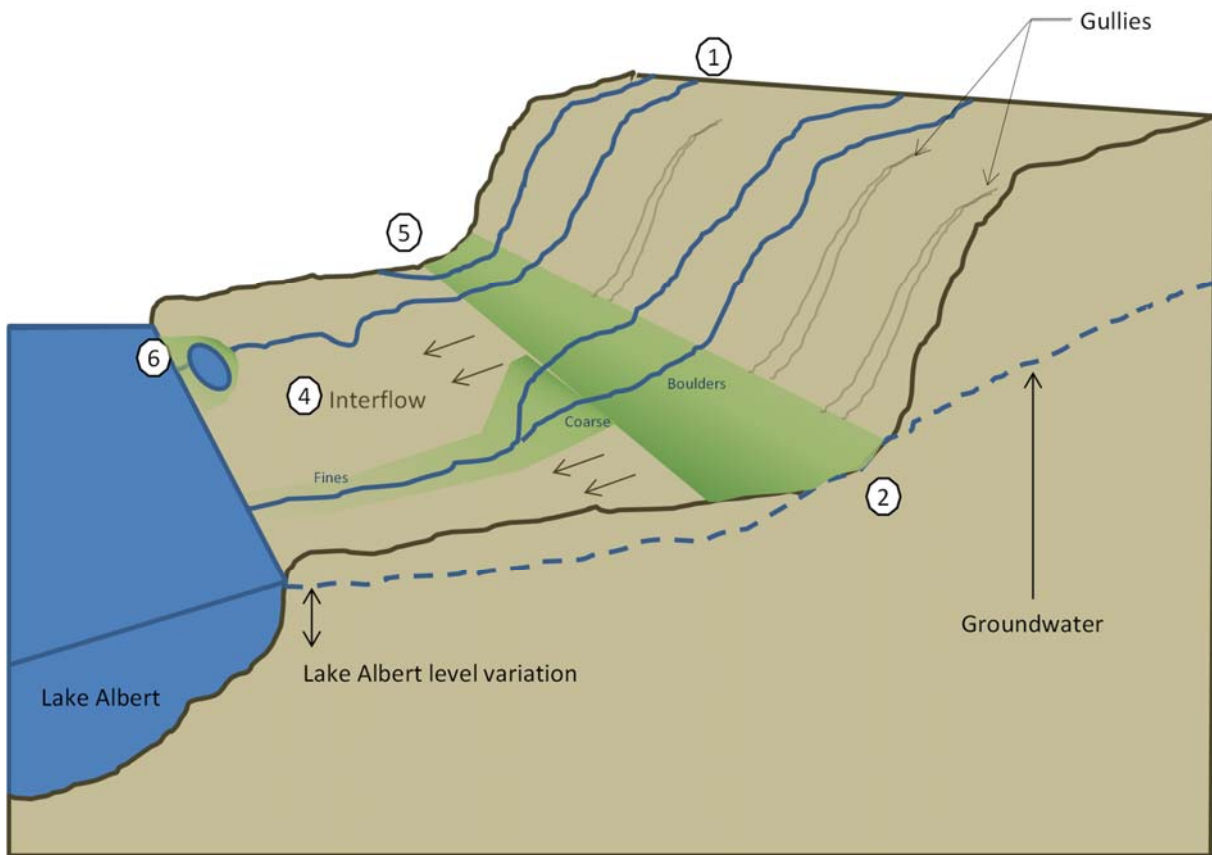

Figure 13: Hydrological Conceptual Model

A total catchment of 65 km² generates runoff during the rainy season that discharges onto the Flats. Water is conveyed through ravines on the steep slopes of the escarpment (1). Water has a strong energy when it reaches the Flats as evidenced by the large boulders within the river bed (see Figure 14a) and by the large gullies that divides the northern shorter sections of the Flats (5) (see Figure 16). Apart from the short section of the Flat in the North, the energy of the discharged water seems to get dissipated very quickly as the slope becomes very Flat and the losses generated by the bushy vegetation visible at the bottom of the escarpment slow down the flow of water. This is a zone of recharge where water infiltrates into the soil (see Figure 14c & Figure 17).





During the dry season, the Flats still receive some water from its upstream catchment. This water is coming from both the soil moisture stored during the rainy season in the catchment and the groundwater seepage as the steep slopes of the escarpment intercept the groundwater (2). Evidence of the groundwater seepage is given by a 100m high bandwidth of green vegetation visible on the lower section of the escarpment during the dry season. Some of the smaller streams disappear from the surface a few hundred metres away from the bottom of the escarpment. This shows that the zone at the bottom of the escarpment is an important zone of recharge of water into the soil.

Some of this water contributes to recharging the aquifer, some will move through the soil towards Lake Albert (4) and the rest is evaporated. Evidence of the water pathway through the soil is shown by the road shown in Figure 15 intercepting the interflow due to the compaction of the soil. The streams that are large enough slowly make their way through densely vegetated wetlands.

An important feature within the Flats system is a pond near the jetty also referred to as 'Luzira' (6). Little is known about the hydrological behaviour of this system. During the dry season, the water level in the pond was measured to be lower than the level of Lake Albert. No water inflow was visible on the surface. It is very likely that the pond receives influx of water during the dry season while it overflows into Lake Albert through a large channel during the wet season.



(a) Boulders



(b) Coarse



(c) Fine

Figure 14: River bed material



Figure 15: Interflow interception due to soil compaction



Figure 16: Gullies observed on the escarpment and plain



Figure 17: Wetland





5.3.4 Water quality

In order to obtain a reasonable water quality baseline, twenty two (22) monitoring stations were pre-selected for possible sample collection and analyses. The metadata for the surface water monitoring sites are given in Table 3. From these sites, ten (10) were assessed in detail with *in situ* measurements and grab sampling, while the remaining sites were monitored *in situ* only. Sites where grab samples were collected and analysed are highlighted in Table 3 and illustrated in Figure 18.

Table 3: Surface water quality monitoring points for the Kingfisher Development Area

Monitoring Point ID	Name or Description	Coordinates		Elevation (m)
		Latitude	Longitude	
SW1*	Tributary associated with proposed road cross section 3 (Kyakapere)	N 01°15'53.6"	E 30°45'27.5"	641
SW2*	Upstream of cross section 3 - Kyakapere (upstream)	N 01°15'50.6"	E 30°45'35.7"	677
SW3	Cross section 2	N 01°16'04.7"	E 30°45'30.7"	639
SW4*	Further upstream of SW5	N 01°15'16.4"	E 30°45'33.0"	676
SW5	Upstream of Spoil Area A(Quarry and Asphalt Plant) (Kowet)	N 01°15'17.2"	E 30°45'27.8"	649
SW6*	On Kamansinig river upstream SW7 (Kachasambo)	N 01°14'24.9"	E 30°45'26.1"	681
SW7	Kamansinig river upstream of the airstrip	N 01°14'20.7"	E 30°45'07.2"	656
SW8	Culvert on Kamansinig river western side of the proposed airstrip	N 01°14'19.5"	E 30°44'45.0"	642
SW9*	river upstream of proposed Spoils Area B - Reservoir (Nyakateke)	N 01°13'40.9"	E 30°45'10.0"	660
SW10	river downstream of proposed Spoils Area B (Nyakateke)	N 01°13'43.8"	E 30°45'03.5"	651
SW11	river below the escarpment and upstream of wetland sensitive areas	N 01°13'42.5"	E 30°44'42.7"	630
SW12*	Kamansinig river inflow to Boguma Lagoon and adjacent to Jetty (associated with Pad 1)	N 01°14'51.3"	E 30°44'21.0"	620
SW13	Small non-perennial stream 70 m upstream of proposed Pad 5	N 01°13'01.0"	E 30°43'27.3"	619
SW14*	Downstream of prior to entering Lake Albert	N 01°13'13.9"	E 30°43'23.1"	624
SW15	Stream from escarpment flowing towards South End Fishing Village (Mugera)	N 01°12'27.0"	E 30°44'04.6"	665
SW16	Downstream of SW15 (Mugera)	N 01°12'27.7"	E 30°44'01.6"	649





SURFACE WATER SPECIALIST REPORT

Monitoring Point ID	Name or Description	Coordinates		Elevation (m)
		Latitude	Longitude	
SW17	Tributary of river on escarpment	N 01°12'43.7"	E 30°44'18.5"	662
SW18	Kamansinig river between SW7 and SW8 (equidistance)	N 01°14'21.30"	E 30°44'55.90"	641
SW21	Site along the pipeline 35 km from the CPF site (east of pipeline)	N 01°24'12.11"	E 31°00'35.24"	1031
SW22	Site along the pipeline 35 km from the CPF site (west of pipeline)	N 01°24'06.02"	E 31°00'39.38"	1023

* - Site initially sampled for metals during December 2013





5.3.5 *In situ* Water Quality

Two (2) sampling site visits were conducted during the dry season. The first site visit commenced on December 23, 2013 and the second on March 20, 2014. Flow measurements were taken at the sites on the major streams where flow and site conditions allowed measurements to be taken. The measured flows are listed in Table 4.

Table 4: Flow rates measured at four (4) surface water monitoring stations on 20 March 2014

Monitoring Sites	Average Flow (m ³ /s)
SW10	0.75
SW11	0.66
SW16	0.43
SW12	1.15

Compact field instruments were used to measure the following parameters:

- pH;
- Electrical Conductivity (EC);
- Dissolved Oxygen (DO);
- Total Dissolved Solids (TDS);

The pH and EC spatial analysis of *in situ* measurements are illustrated in Figure 16, and have been grouped by the general location within the site (north, central and south) in Table 5 below.

Table 5: Surface water in situ measurements for selected sites (December 2013)

Monitoring Point ID	TDS (mg/l)	EC (µs/cm)	pH (pH Units)	DO (mg/l)
SW1	730	1030	7.73	3.73
SW2	554	824	8.92	7.3
SW4	390	558	9.06	8.45
SW5	390	-	8.90	-
SW6	351	515	9.01	6.5
SW7	513	742	7.93	4.48
SW12	914	1312	7.30	1.49
SW9	172	250	8.68	6.19
SW13	621	875	7.79	3.12
SW14	214	323	6.70	0.3
SW15	244	325	8.19	-
SW17	291	420	8.53	-

Green (South) represents the southern areas that are predominantly wetlands, south of the river. *Blue* (*North*) represents streams north of the majority of the project facilities. *Orange* represents streams located centrally and associated with the majority of site facilities.

Water quality has a direct influence on aquatic life, soil quality if irrigated (small scale farming) and human health when used for various domestic purposes including consumption. Although these measurements only provide a “snapshot”, they can provide valuable insight into the characteristics and interpretation of a specific sample site at the time of the sample collection.





5.3.6 Water Quality Analysis

Initial samples were collected by Eco & Partners and sent to the National Water Quality Reference Laboratory in Uganda (Certificate of Analysis in APPENDIX B).

The second round of sampling (27 March 2014) focused on a more detailed analysis. In addition to the *in situ* water quality parameters, a range of constituents were selected for further assessment. Water samples were collected in various sample collection vials, stored at 4°C and delivered to Jones Environmental Laboratory in the United Kingdom where the following variables were evaluated (Certificate of Analysis in APPENDIX C):

- Physico-chemical:
 - pH, TDS, total alkalinity as CaCO₃ (Talk), EC @ 25°C and total dissolved hardness as CaCO₃ (THard) and silica (SiO₂);
- Major Ions:
 - Calcium (Ca), magnesium (Mg), sodium (Na), fluoride (F), sulphate (SO₄) and chloride (Cl);
- Nutrients
 - Ortho-phosphate (PO₄), Nitrate as N (NO₃-N) and Ammoniacal Nitrogen as N (NH₃-N);
- Inorganics and Trace Metals:
 - Dissolved Metals: Aluminium (Al), Barium (Ba), Beryllium (Be), Cadmium (Cd), Chromium (Cr), Copper (Cu), Iron (Fe), Lead (Pb), Manganese (Mn), Mercury (Hg), Nickel (Ni), Potassium (K), Vanadium (V), Zinc (Zn);
 - Metalloids: Arsenic (As); and
 - Halogens: Fluoride (F)
- Organics and Oils:
 - Extractable Petroleum Hydrocarbons (EPH) and Gasoline Range Organics (GRO)
- Polyaromatic Hydrocarbons (PAH)

The water quality results are discussed below.

Lake Albert

Sampling took place on the 26 May 2014 along the shores of Lake Albert at the shore points described in Table 6 and illustrated in Figure 19, as part of the aquatic biodiversity survey led by Dr T Kairania.

Table 6: Sampled sites in nearshore waters of Lake Albert along Kingfisher flats (aquatic biodiversity survey led by Dr T Kairania)

Parameter	Name of Transect			
	Pad 1	Pad 2	Pad 3	Pad 4A
Shoreline features	High eroded banks; just to north of Lagoon; soils - sandy; Hinterland: seasonal wetland with eroded <i>Miscathedium</i> and patches of <i>Typha</i> plus <i>Phragmites</i>	Close to seasonal stream; high eroded banks of sandy clay; hinterland – heavily grazed grassland; big community at a distance	Fairly high eroded banks, soils -sandy clay; immediate shore lined with low thickets. Shoreline waters lined with clumps of <i>Cyperus laevigatus</i>	Pad 4-2 just north of village settlement in short scattered woodland; Shoreline few meters from escarpment,





SURFACE WATER SPECIALIST REPORT

Parameter	Name of Transect			
	Pad 1	Pad 2	Pad 3	Pad 4A
<i>Inshore (10 m)</i>				
Coordinates	1°14'55.02"N 30°44'21.69"E	1°15'18.80"N 30°44'52.07"E	1°13'53.74"N 30°43'47.34"	1°16'46.38"N 30°45'32.99"E
Water depth & bottom type (Dry season)	1.1 m; sandy bottom with plant debris	2.6 m; clay mixed with shells	1.8 m; Sandy with live plant material	4.9 m; Soft mud
Water depth & bottom type (Wet season)	1.5 m; sandy bottom with plant debris	4.4 m; clay mixed with shells	2.5 m; Sandy with live plant material	3.3 m; Soft mud
<i>Offshore (2 km)</i>				
Coordinates	1°15'47.25"N 30°43'41.68"E	1°16'14.81"N 30°44'14.74"E	1°14'27.86"N 30°42'51.99"E	1°17'34.44"N 30°44'47.33"E
Water depth & bottom type (Dry season)	24.6 m; fine clay mixed with shells	14.0 m; Rocky with crushed shells	27.3 m; Very fine dark, smooth sand	28.6 m; Not determined
Water depth & bottom type (Wet season)	26.9 m; fine clay mixed with shells	13.5 m; Rocky with crushed shells	27.3 m; Very fine dark, smooth sand	28.1 m; Not determined

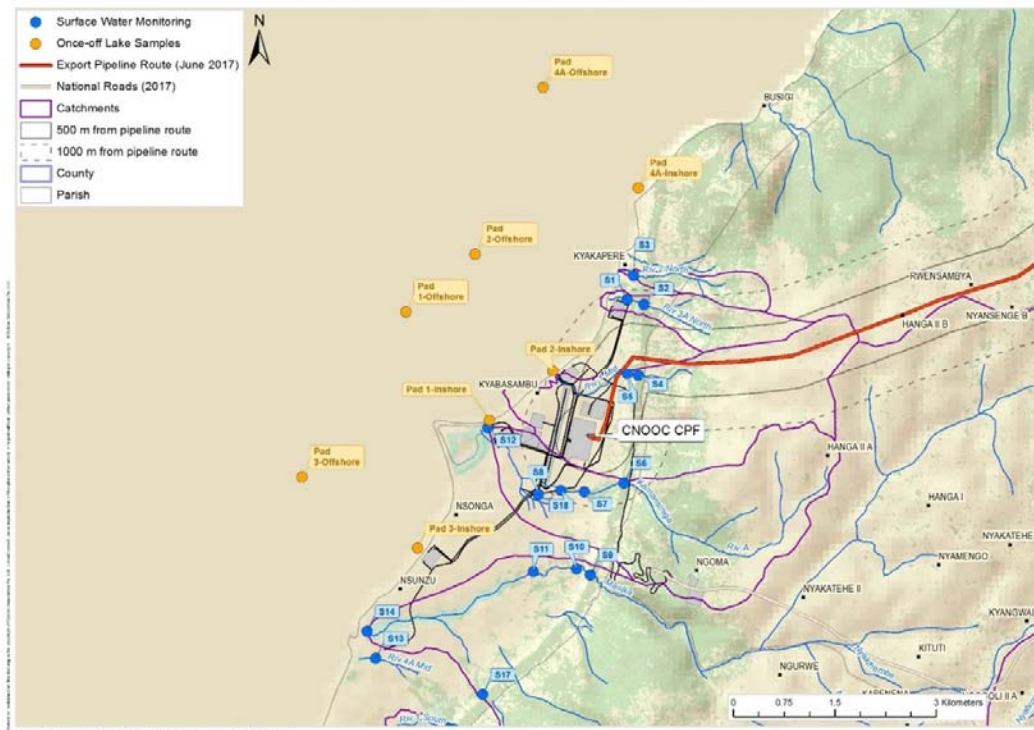

Figure 19: Lake Albert water quality sites (aquatic biodiversity survey led by Dr T Kairania, May 2014)





5.3.6.1 Results and Discussion

The results for the samples collected in December 2013 for SW 1, 2, 4, 6, 9, 12 and 14 were analysed for the following metals only: cadmium, chromium, lead, mercury, iron, aluminium, arsenic, copper, manganese, zinc, cobalt, nickel and selenium. In cases the limits detected were well below the Uganda National Standard (NEMA, 1995). The data is included as APPENDIX B.

The water quality results for samples collected during March 2014 are tabulated in Table and are grouped (colour coded) according to general areas of impacts. The water quality results were compared to the local Ugandan Acceptable Standards for drinking (NEMA, 1996), and the World Health Organisation (WHO) for Drinking Water (WHO, 2011). For each parameter, the more stringent of the two standards was used as a basis for comparison. The red cells indicate points where results exceed the defined limit and those underlined indicate that levels detected were less than the detection limit.

For the pre-development phase, the assessment of the baseline water quality results during the dry season (March 2014) revealed the following:

- The pH of the waters measured at the sites seem to fall within the upper limit of the standards range and exceeding this limit at five of the sampled sites with the maximum pH recorded at SW03 (lab pH 8.88) and SW04 (in situ pH 9.06);
- The pH at SW14 is lower than the majority of the sites. The lower pH conditions could result in an increase in trace metals as is shown by the elevated Fe and Mn concentrations at SW14, 4.28 and 0.8 mg/l, respectively. This area has also been reported to have elevated Ti levels, which might explain the occurrence of Fe in addition to possible re-suspension of sediments during rainy days (see Soils study). The shoreline closer to SW14 is typically characterised by total iron concentration of approximately 1 mg/l, and as a result the Fe concentrations cannot be attributed to Lake water intrusions onto the wetland. The dissolved oxygen concentration (0.3 mg/l *in situ*) at SW14 further supports these reducing conditions. Continuous monitoring is necessary;
- TDS and EC levels on site for SW01 were relatively high (TDS 730 mg/l and EC 1030 µS/cm). This may have been due to high concentrations of organic matter associated with the wetland system upstream of this site or contributions from the upstream villages; and
- Various traces of PAHs were also detected, however not at levels that cause concern. These are also constituents of concern that should be monitored for throughout the construction, operation and closure phases of any oil and gas project.

Overall, water quality during the dry season is generally good. A concern could be during the wet season where there is potential for humic acids (from surrounding land areas such as wetland systems) to increase pH levels and introduce metals into Lake Albert.

The water quality of Lake Albert (**Error! Reference source not found.**) as indicated by grab samples taken in May 2014, shows that the lake pH is strongly alkaline, and falls outside of the Uganda National Standards, however except for faecal coliform count which indicated low levels of faecal contamination at both the inshore and offshore sites, the other parameters measured are within the Uganda National Standards.

The list of proposed variable to be measured must also be included for those samples taken in the lake during the construction and operational phases of the project.





SURFACE WATER SPECIALIST REPORT

Table 7: Baseline surface water monitoring results for the dry season (March 2014)

Water Quality Variable	Units	WHO drinking water Standards	Ugandan Standards (NEMA, 1996)	Surface water monitoring points									
				SW02	SW03	SW09	SW17	SW14	SW15	SW19	SW20	SW21	SW22
				20/03/2014	20/03/2014	21/03/2014	23/03/2014	23/03/2014	23/03/2014	22/03/2014	23/03/2014	24/03/2014	24/03/2014
Physico-chemical													
pH	pH units	6.5 to 8.5	6.5 to 8.5	8.79	8.88	8.48	8.55	6.76	8.36	8.72	8.87	7.32	7.03
Total Alkalinity as CaCO ₃	mg/l	-	500	416	308	146	232	178	160	274	302	134	136
Electrical Conductivity @25C	µS/cm	-	2500	853	621	274	469	377	330	517	648	319	320
Total Dissolved Solids	mg/l	600	1200	506	363	158	231	217	183	302	326	187	176
Silica	mg/l	-	-	27.6	26.8	32.9	13.8	27.1	28	30	2.4	33.3	21
Total Hardness as CaCO ₃	mg/l	500	500	242	178	100	153	133	113	174	138	112	122
Major Dissolved Ions													
Sulphate as SO ₄	mg/l	250	200	47.92	16.75	4.65	0.2	0.27	0.34	5.92	11.38	7.43	7.75
Chloride as Cl ⁻	mg/l	-	-	11.7	7.4	1.4	4.5	14.7	2.6	4.6	19.9	5.8	7.7
Ortho Phosphate as PO ₄	mg/l	-	-	2.11	1.18	0.17	0.7	0.09	0.36	0.88	0.03	0.75	0.31
Nitrate as NO ₃ -N	mg/l	-	5	0.19	0.29	0.15	0.27	0.025	0.09	0.23	0.025	0.21	0.15
Ammoniacal Nitrogen as NH ₃ -N	mg/l	-	1	0.22	0.47	0.25	0.5	0.59	0.09	0.19	0.08	0.44	0.56
Fluoride as F ⁻	mg/l	1.5	-	1.3	1.2	0.5	0.8	0.5	0.7	1	0.5	0.15	0.15
Magnesium as Mg ²⁺	mg/l	-	-	31.1	20.3	11.6	18.7	15.2	14.6	21.5	26.1	13	12.5
Sodium as Na ⁺	mg/l	200	-	108.1	77.1	17.1	36.7	25.4	26.5	50.5	64.5	16.3	11.3
Potassium as K ⁺	mg/l	-	-	5.2	2.9	2	3.2	3.9	1.7	2.5	40.4	7.6	8
Calcium as Ca ²⁺	mg/l	-	-	44.5	37	20.5	29.7	27.7	20.8	33.6	11.4	22.9	27.9
Trace Metals (Dissolved)													
Aluminium as Al	mg/l	0.1	0.2	0.01	0.01	0.01	0.01	0.01	0.01	0.01	0.01	0.01	0.01
Arsenic as As	mg/l	0.01	0.01	0.00	0.00	0.00	0.00	0.00	0.00	0.00	0.00	0.00	0.00
Barium as Ba	mg/l	0.7	-	0.046	0.049	0.065	0.042	0.101	0.05	0.042	0.093	0.079	0.051
Beryllium as Be	mg/l	-	-	0.00	0.00	0.00	0.00	0.00	0.00	0.00	0.00	0.00	0.00
Boron as B	mg/l	-	-	0.01	0.01	0.01	0.01	0.01	0.01	0.01	0.04	0.01	0.02
Cadmium as Cd	mg/l	0.003	0.01	0.00	0.00	0.00	0.00	0.00	0.00	0.00	0.00	0.00	0.00
Chromium as Cr	mg/l	-	0.05	0.00	0.00	0.00	0.00	0.00	0.00	0.01	0.00	0.00	0.00
Copper as Cu	mg/l	-	1	0.0035	0.0035	0.0035	0.0035	0.0035	0.0035	0.0035	0.0035	0.0035	0.0035
Iron as Fe	mg/l	0.3	0.03 to 3.5	0.01	0.01	0.094	0.01	4.28	0.052	0.01	0.01	0.111	0.121
Lead as Pb	mg/l	0.01	0.01	0.01	0.01	0.01	0.00	0.01	0.01	0.01	0.00	0.01	0.01
Manganese as Mn	mg/l	0.1	0.1 to 0.5	0.005	0.004	0.01	0.003	0.849	0.007	0.001	0.001	0.026	0.183
Mercury as Hg	mg/l	0.006	0.001	0.0005	0.0005	0.0005	0.0005	0.0005	0.0005	0.0005	0.0005	0.0005	0.0005
Nickel as Ni	mg/l	0.07	0.02	0.00	0.00	0.00	0.00	0.00	0.00	0.00	0.00	0.00	0.00
Selenium as Se	mg/l	0.04	0.01	0.00	0.00	0.00	0.00	0.00	0.00	0.00	0.00	0.00	0.00
Vanadium as V	mg/l	-	-	0.00	0.01	0.00	0.00	0.00	0.00	0.00	0.00	0.00	0.00



SURFACE WATER SPECIALIST REPORT

Water Quality Variable	Units	WHO drinking water Standards	Ugandan Standards (NEMA, 1996)	Surface water monitoring points									
				SW02	SW03	SW09	SW17	SW14	SW15	SW19	SW20	SW21	SW22
				20/03/2014	20/03/2014	21/03/2014	23/03/2014	23/03/2014	23/03/2014	22/03/2014	23/03/2014	24/03/2014	24/03/2014
Zinc as Zn	mg/l	-	3	0.02	0.04	0.07	0.02	0.04	0.05	0.02	0.04	0.05	0.04
Polyaromatic Hydrocarbons (Organics)(PAH)													
Naphthalene	µg/l	-	-	0.007	0.007	0.007	0.184	0.007	0.007	0.007	0.007	0.007	0.007
Acenaphthylene	µg/l	-	-	0.0065	0.03	0.05	0.0065	0.0065	0.0065	0.0065	0.0065	0.0065	0.0065
Acenaphthene	µg/l	-	-	0.0065	0.04	0.07	0.0065	0.0065	0.0065	0.0065	0.0065	0.0065	0.0065
Fluorene	µg/l	-	-	0.007	0.05	0.06	0.007	0.007	0.007	0.007	0.007	0.007	0.007
Phenanthrene	µg/l	-	-	0.02	0.05	0.06	0.07	0.02	0.03	0.03	0.02	0.02	0.03
Anthracene	µg/l	-	-	0.0065	0.02	0.02	0.0065	0.0065	0.0065	0.0065	0.0065	0.0065	0.0065
Fluoranthene	µg/l	-	-	0.006	0.02	0.02	0.02	0.006	0.006	0.006	0.006	0.02	0.006
Pyrene	µg/l	-	-	0.0065	0.02	0.02	0.03	0.0065	0.0065	0.0065	0.0065	0.02	0.0065
Benzo(a)anthracene	µg/l	-	-	0.0075	0.02	0.02	0.03	0.0075	0.02	0.0075	0.0075	0.02	0.02
Chrysene	µg/l	-	-	0.0055	0.02	0.02	0.02	0.0055	0.0055	0.0055	0.0055	0.02	0.0055
Benzo(bk)fluoranthene	µg/l	-	-	0.009	0.02	0.009	0.03	0.009	0.009	0.009	0.009	0.009	0.009
Benzo(a)pyrene	µg/l	-	-	0.008	0.008	0.008	0.008	0.008	0.008	0.008	0.008	0.008	0.008
Indeno(123cd)pyrene	µg/l	-	-	0.0055	0.0055	0.0055	0.0055	0.0055	0.0055	0.0055	0.0055	0.0055	0.0055
Dibenzo(ah)anthracene	µg/l	-	-	0.005	0.005	0.005	0.005	0.005	0.005	0.005	0.005	0.005	0.005
Benzo(ghi)perylene	µg/l	-	-	0.0055	0.0055	0.0055	0.0055	0.0055	0.0055	0.0055	0.0055	0.0055	0.0055
PAH 16 Total	µg/l	-	-	0.0975	0.29	0.34	0.384	0.0975	0.0975	0.0975	0.0975	0.0975	0.0975
Benzo(b)fluoranthene	µg/l	-	-	0.005	0.01	0.005	0.02	0.005	0.005	0.005	0.005	0.005	0.005
Benzo(k)fluoranthene	µg/l	-	-	0.005	0.005	0.005	0.005	0.005	0.005	0.005	0.005	0.005	0.005
Oil and Grease													
EPH (C8-C40)	µg/l	-	-	0.5	0.5	0.5	0.5	0.5	0.5	0.5	0.5	0.5	0.5
GRO (>C4-C8)	µg/l	-	-	0.5	0.5	0.5	0.5	0.5	0.5	0.5	0.5	0.5	0.5
GRO (>C8-C12)	µg/l	-	-	0.5	0.5	0.5	0.5	0.5	0.5	0.5	0.5	0.5	0.5
GRO (>C4-C12)	µg/l	-	-	0.5	0.5	0.5	0.5	0.5	0.5	0.5	0.5	0.5	0.5

Green indicates southern areas that are predominantly wetlands, south of the river. Blue are streams north of most of the project facilities. Purple are streams located outside the immediate site.



SURFACE WATER SPECIALIST REPORT

Table 8: Water quality data for samples taken at sites in nearshore waters along Kingfisher Flats, Lake Albert (May 2014)

Parameters	Units	Pad 1		Pad 2		Pad 3		Pad 4A		*Nat Std
		I/S	O/S	I/S	O/S	I/S	O/S	I/S	O/S	
Total Depth	m	1.5	24.3	2.6	13.5	1.8	27.3	3.3	28.1	
Secchi Depth	m	0.7	0.93	0.81	0.92	0.71	0.95	1.01	0.96	
Dissolved Oxygen	mg/L	7.53	7.80	7.03	7.94	7.56	7.72	7.50	7.95	NS
Temp	°C	28.4	28.1	27.8	28.1	28.5	28.1	27.8	27.8	20-35*
Conductivity	µS/cm	634	633	633	633	632	634	633	633	2500
pH	--	9.60	9.62	9.61	9.61	9.45	9.63	9.66	9.66	6.5-8.5
Alkalinity	mg/L	316	332	316	360	324	320	240	320	500
Hardness	mg/L	180	200	160	240	180	200	180	160	500
TDS	mg/L	304	313	317	312	310	312	304	313	1200
TSS	mg/L	3	2	1	1	2	1	1	1	0
Turbidity	NTU	2	2	2	3	4	2	2	2	10
Calcium: Ca ²⁺	mg/L	20.8	10	24	40	24	24	24	24	75.0
Magnesium: Mg ²⁺	mg/L	30.7	38.4	24	33.6	28.8	33.6	28.8	24	50.0
Fluoride: F ⁻	mg/L	1.2	1.3	1.2	1.2	1.1	1.3	1.1	1.3	1.5
Iron	mg/L	0.01	0.01	0.02	1.01	0.04	0.01	0.00	0.06	5
Sulphate	mg/L	11	11	10	10	11	11	10	10	200
Chloride: Cl ⁻	mg/L	0.05	0.05	0.05	0.05	0.05	0.05	0.05	0.05	500
BOD ₅ at 20°C	mg/L	0.0	0.6	0.9	0.4	0.5	0.2	0.3	0.6	30*
COD	mg/L	11	10	11	15	7	15	14	12	100*
SRP	mg/L	0.003	0.000	0.001	0.002	0.002	0.002	0.003	0.000	5000*
TP	mg/L	0.026	0.034	0.029	0.031	0.044	0.036	0.034	0.034	10
Nitrate	mg/L	0.023	0.024	0.095	0.031	0.055	0.032	0.035	0.024	4.5
Nitrite	mg/L	0.008	0.007	0.010	0.010	0.002	0.001	0.001	0.007	3
Ammonia	mg/L	0.008	0.020	0.022	0.029	0.015	0.010	0.012	0.020	1
Total Nitrogen	mg/L	0.32	0.122	0.185	0.372	0.122	0.140	0.122	0.122	10
Chlorophyll a	µg/L	2.1	2.1	2.1	1.0	1.0	2.1	3.1	3.1	NS
Faecal coliform	CFU/100mL	50	25	2	2	10	5	7	3	0

I/S: inshore; O/S: offshore; Nat Std: Uganda National Standard





5.4 Hydrological modelling

5.4.1 Peak calculation

The rational method was used to calculate peak rainfall for the 1 in 50 and 1 in 100 year annual storm recurrence interval for each catchment area. A Mean Annual Precipitation of 1 200 mm was used in the peak calculation as reported by UNDP&WMO, (1974). The 24 hour storm rainfall was calculated using the method described in section 5.2.2. Catchments for five rivers namely; Mid 1, North 2, Mid 2, North1, Mid 3 Masika were delineated for floodline analysis while catchments for rivers crossing the pipeline namely Pipeline River 1, Pipeline River 2 were also delineated. In order to account for flood contribution from the south most river (South 1) the peak flow of both Mid 3 Masikia and South 1 was also calculated. The catchments are shown in Table 9.

Table 9: Catchment properties used in the Rational method

Catchment Name	Area (km ²)	Stream length (m)	Elevation at 10% of Slope	Elevation at 85% of Slope	Slope (m/m)	Time of Concentration (hrs)
Mid 1	6.99	1422	621.6	646.5	0.023	0.4
North 2	1.38	565	621.9	648.3	0.062	0.1
Mid 2	7.63	2645	624.5	644.8	0.010	0.8
North1	0.74	527	626.2	674.4	0.122	0.1
Mid 3 Masikia	46.36	1937	614.7	636.7	0.015	0.6
Pipeline Rivier 1	42.26	11434	697.2	1035	0.039	1.5
Pipeline River 2	76.95	5688	778.8	979.9	0.047	0.8
Mid 3 Masikia and South 1	61.12	1937	614.7	636.7	0.015	0.6

The properties of each of the catchment as applied in the rational method are shown in Table 9. Considering the topography for the study area, the elevation at 10% of 85% of the slopes was calculated for both the lower and upper section of the rivers separately. The lower section of the river stretched up to the edge of the escarpment while the Upper section extended from the edge of the escarpment to the head waters of each catchment as shown in the catchment map (Figure 20).

Table 10: 50 year and 100 year Peak flows calculated using the Rational Method

River Name	1 in 50 Flood Peak (m ³ /s)	1 in 100 Flood Peak(m ³ /s)
North1	14.7	18.0
North 2	25.9	34.1
Mid 1	82.9	109.2
Mid 2	55.9	73.6
Mid 3 Masikia	395.6	518.7
Pipeline River 1	175.8	230.6
Pipeline River 2	457.0	598.0
Mid 3 Masikia and South 1	474.0	620.8



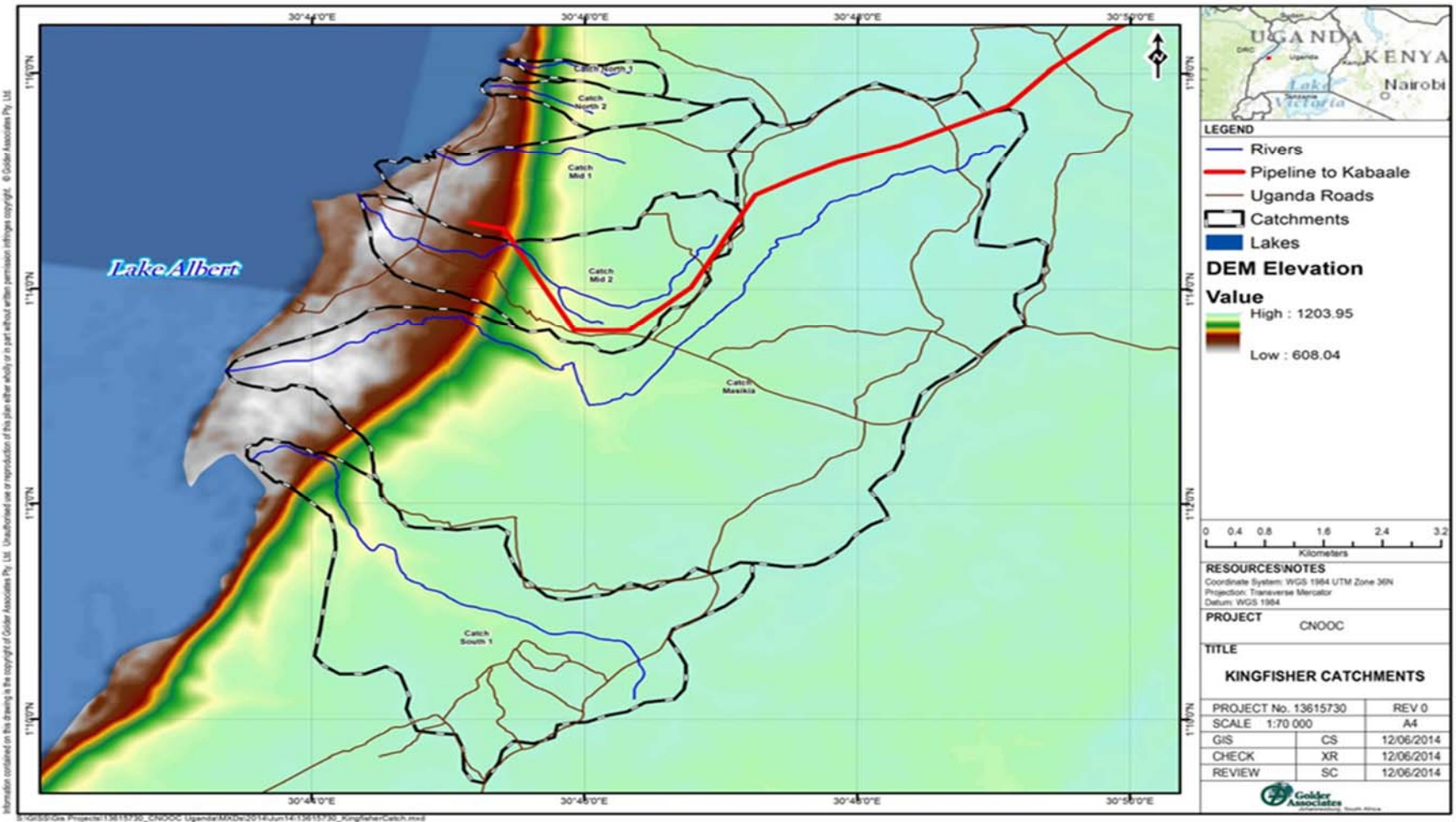

Figure 20: Site specific catchments



5.4.2 Floodlines

The HEC-RAS program was used to route the peak discharge for each of the rivers under study. Cross sections were generated using 1m x 1m Digital Elevation Model (DEM). The peak flows calculated using the rational method was applied in the model. Slope was used as boundary conditions with the exception of the downstream cross section (chainage 672.8m) of Mid River 2 where a critical depth was applied. The reason for choice is explained in the assumptions and recommendations section. A roughness coefficient (Manning n) of 0.035 was applied for both channel and overland flow as the area fitted the floodplain with pasture and farmland description according to data published by (Munson, Young, Okiishi, & Huebsch, 2009) Munson, R. *et al* (1990). The 1 in 50 years and 1 in 100 floodline was generated and plotted as seen in Figure 21 and Figure 22.

Assumptions and Limitations

The area where the proposed site lies is generally flat and as a result the river line is not always well defined. Even though the resolution of the DEM was high, the accuracy was low. The low accuracy of the DEM combined with varying depression storages meant the river could not always be defined accurately. As a result assumptions had to be made concerning the river banks. In some cases for example River Mid 2, according to the DEM data the elevation was higher downstream which according to observations from our site visit is not the case hence critical flow was applied as the downstream boundary condition. A decision was then made to extend the probable floodline based on the available result and there was no more accurate topographical data as the rivers emptied into the Lake. This information is shown with a dotted line in the floodline map as shown in Figure 21 and Figure 22.

It is recommended to adhere to the 1 in 100 year floodline limit for construction or keep a 100 m buffer along the rivers as per the IFC standards (International Finance Corporation, 2007). According to the IFC report it is advised to “avoid construction of facilities in a floodplain, whenever practical, and within a distance of 100 m of the normal high-water mark of a water body or water well used for drinking or domestic purposes.”

As shown in Figure 21 the following structures fall within the 1 in 100 floodline. It is recommended that these structures are relocated where possible:

- Mid 1 - Pad 2, Material yard and Spoil area C
- Mid 2 – Pad 1 and Spoil Area A/Burrow pit
- Masikia – Spoil Area B
- South 1 – Pad 5 (proposed)

The airstrip also runs through both the 1 in 50 and 1 in 100 year floodline. A bridge or culvert is required to mitigate against the risk of flooding.

A higher level of certainty of the flooding risk could be further achieved if more reliable local rainfall were to be obtained amongst other essential more accurate data inputs. It is for this reason coupled with the low lying nature of the of the Kingfisher Development Area that over and above relocating structures according to the determined floodline it is recommended that all structures be raised in order to mitigate against the risk of flooding. Based on the floodline results, it is recommended that proposed structures that fall within the 1 in 100 year floodline be raised by 1 metre.



Figure 21: 1 in 50 and 1 in 100 year flood lines for the Flats





SURFACE WATER SPECIALIST REPORT

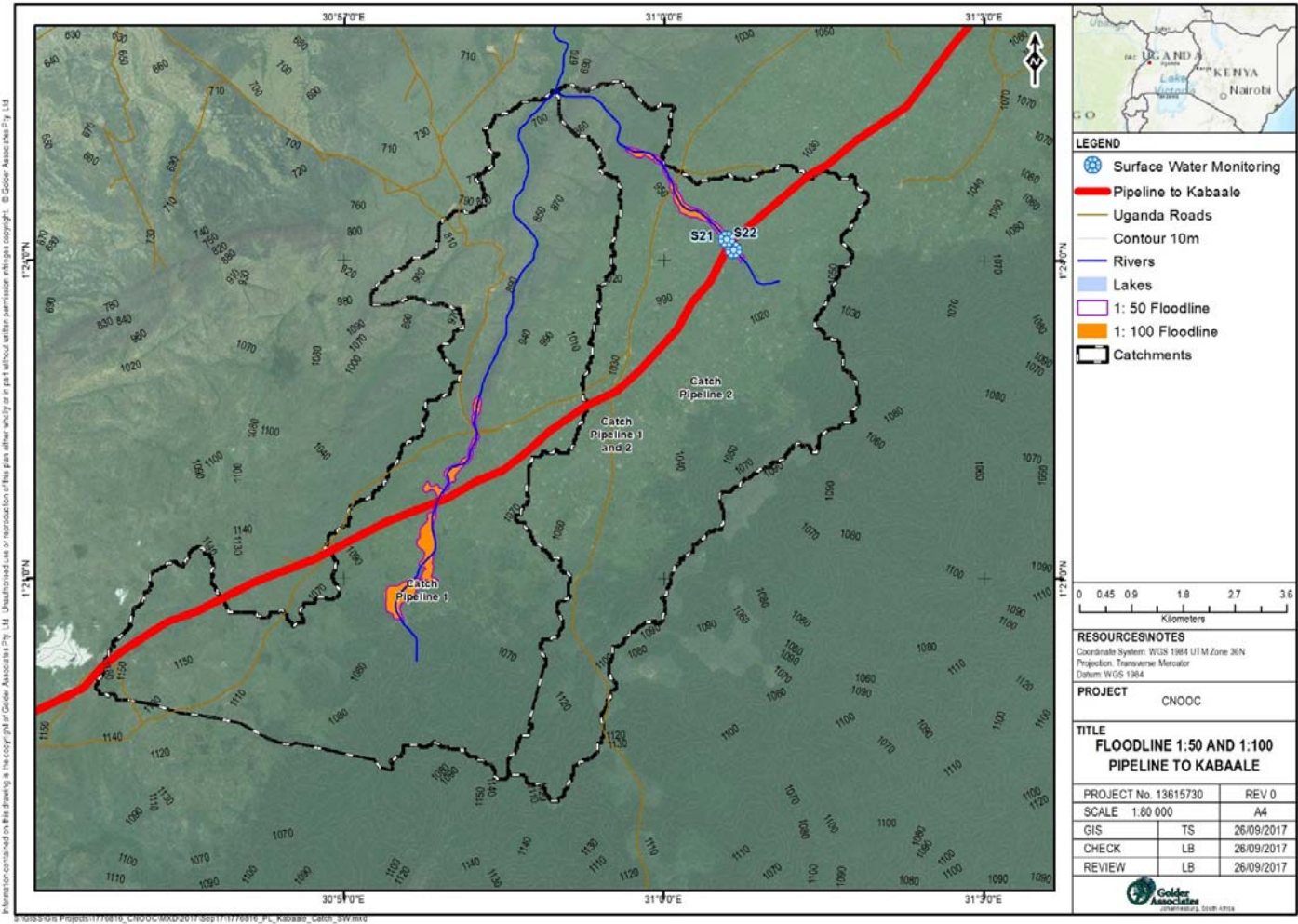

Figure 22: 1:100 floodlines along the pipeline routing





6.0 IMPACT ASSESSMENT

6.1 Major areas of concern for surface water impacts

The major areas of concern for the surface water impacts are water quality and quantity (flow) impacts on the rivers and streams draining to the lake in relation to (Figure 23):

- The construction camps and associated activities;
- Well pads and associated activities;
- Central processing facility and associated activities; and
- Pipelines and associated activities.

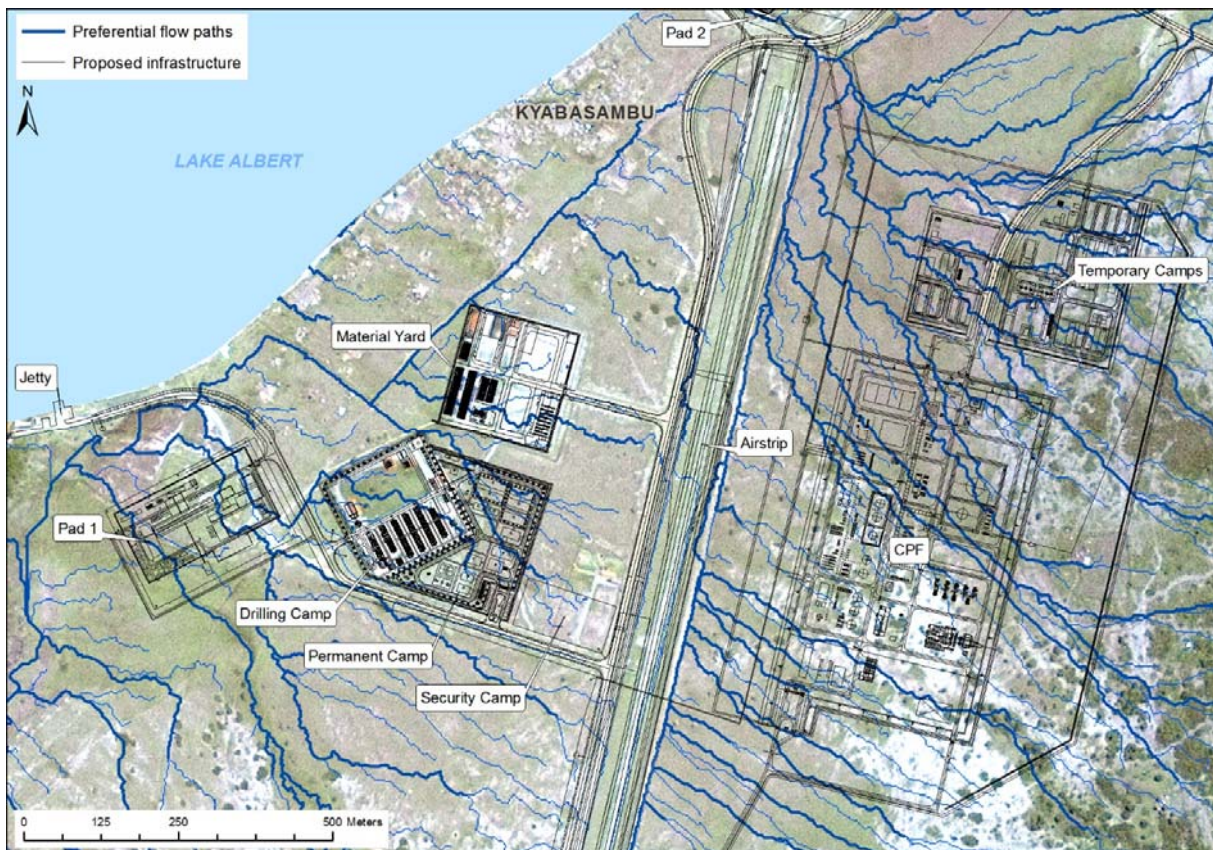

Figure 23: Proposed infrastructure in relation to preferential flow paths

The impacts are further elaborated in the sections to follow.

6.1.1 Camps (temporary and permanent)

The major activities around the camps that could have a negative impact on the surface water resources include erosion and sedimentation from areas that have been cleared of vegetation, domestic sewage treatment and small oil and chemical spills from equipment.

6.1.2 Well pads

All development and production wells in the Kingfisher Development Area will be drilled from four well pads on the eastern shores of Lake Albert. Three of these well pads currently exist and will be upgraded to meet





requirements for oil production. The well-fluids will be transported to a Central Processing Facility (CPF) via separate flowlines from each of the four well pads. The final development is expected to consist of 20 production wells (producers) and 11 water injection wells (injectors). The well depth will be approximately 1700 m below the floor of Lake Albert. Horizontal departure of the well from the well pad location will typically be around 3 800 m.

After well completion, the rig and the auxiliary facilities will be removed and the well will be connected to a manifold combining well fluids from all of the wells on the well pad into a single flowline to the CPF. Each production well pad is expected to comprise:

- Production well heads and manifolds;
- Water injection wells and manifolds;
- Utility Systems;
- Production and test flow meters;
- Pig Launcher/ Receiver;
- Chemical injection system;
- Closed drain system; and
- Equipment room to accommodate instrumentation, telecom, and electrical equipment.

Simultaneous production and drilling on the well pads will occur for the first 7 years, until the project reaches full production. The design will allow for the drilling rig to move between different slots without shutting down production on the well pad.

Drilling waste

Once drilling commences, drilling fluid (otherwise known as 'mud') is continuously circulated down the drill pipe and back to the surface equipment. The main functions of drilling mud are to remove rock cuttings to the surface, generated by the drill bit, maintain wellbore stability, cool and lubricate the drill bit, seal permeable formations and transmit hydraulic energy to the drilling tools and bit. The risk of uncontrolled flow from the reservoir to the surface is further reduced by using blowout preventers, a series of hydraulically actuated steel rams that can close around the drill string or casing to quickly seal off a well. Steel casing is run into completed sections of the borehole and cemented into place. The casing and cement provide structural support to maintain the integrity of the borehole, isolate underground formations and protect useable underground sources of groundwater.

The waste produced during drilling will include:

- Hazardous Solids (used chemical containers, fuel storage containers, oil-contaminated rags, used batteries, used filters, fluorescent tubes, power unit/transport maintenance wastes, paint waste);
- Hazardous solids (potentially contaminated cement slurry);
- Hazardous Liquids (used oil, waste chemicals, rinsate, thinners, viscofiers, solvents, acids, treating chemicals, other used chemicals in drums);
- Non Hazardous Liquids (sewage effluent, grey water);
- Non Hazardous Solids (construction materials, packaging wastes, paper, scrap metal, plastics, glass);
- Drilling Cuttings (solids), coarse and fine particles - aqueous (water based);
- Drilling Cuttings (solids), coarse and fine particles – synthetic;
- Drilling Liquids (including clear liquids from dewatering of aqueous drill cuttings); and





- Completion Fluids (solids, residual drilling fluids, hydrocarbons, acids, glycol, methanol, other).

Produced Water Injection

A total of 11 water injection wells are planned on the well pads. Water injection is intended to meet two objectives - disposal of large quantities of produced water, removed from the well fluids at the CPF, in a safe and environmentally responsible manner; and assisting to maintain reservoir pressures throughout the life of the project. Injection water will consist of a combination of produced water, water from potentially oil contaminated (POC) areas at the CPF and make up water from Lake Albert. Injection of chemical additives at the well pad will not be required. A wide variety of additives will be required but these will be injected in different areas of the produced water circuit at the CPF, prior to delivery to the wells

Production Waste Generated on the Well pad

In order to handle oily drainage from pipelines and equipment, each well pad will be provided with an underground closed drain system leading to a sump with a submersible pump. The levels will be monitored and the sump periodically emptied into a mobile tanker for handling at the CPF.

Only small quantities of solid waste will be generated, once drilling is completed. The wells are unmanned and will be remotely operated from the CPF over extended periods, without intervention on the well pad. During maintenance, small quantities of potentially oil contaminated and non-hazardous waste will be generated. These will be separated into non-hazardous and hazardous components, delivered to the CPF for temporary storage and then recycled, where possible, or earmarked for disposal by a certified hazardous waste contractor. CNOOC indicates that NORM is not expected in the pigging wastes. Estimated quantities of potentially hazardous waste are less than 0.5 t/well/year.

The surface water impacts from the well pads are therefore related to contaminated run-off from the well pads due to the drilling waste produced, and may be both related to water quality and aesthetics of poorly disposed solid waste. Once drilling has ceased there are likely to be small amounts of potentially oil contaminated and non-hazardous waste generated.

6.1.3 Central Processing Facility

The well-fluids from the CNOOC Kingfisher wells will be sent to a Central Processing Facility (CPF) on the Buhuka flats. Figure illustrates the CPF and associated infrastructure. Nearly three quarters of the total volume of fluids from the wells over the 25-year period will be formation water. The well-fluids will be processed in the CPF to separate formation water and associated gas from the oil phase. The oil will be stabilized, desalted and dehydrated to meet the export specification. Associated gas will be separated and utilized as fuel gas for power generation, the heating system and other utilities. Combined power generation with LPG recovery is proposed to utilize excess associated gas.

Produced water from the separators will be treated to achieve the injection water specification. Produced water, along with treated lake water from the CPF, will be injected into the reservoir. Lake water will be pumped to the CPF via a dedicated flow line running from the Lake Albert intake facilities ().

The CPF will comprise the following activities and areas:

- Oil Separation Flash Gas facilities;
- Gas Treatment & Compression facilities;
- Produced Water Treatment & Injection facilities;
- Oil Storage & Export facilities;
- Ground flare;
- Power Generation plant;
- Electrical substation;





- Water and wastewater (sewage) treatment plant;
- Fire water and pumps;
- Plant Utilities area;
- Control room and administrative buildings;
- Maintenance workshop;
- Gatehouse; and
- Perimeter fencing, lighting and internal access road system.

The CPF therefore has several clean and dirty areas, with the main areas of concern for potential surface water pollution linked to the following areas: oil separation flash gas facilities; produced water treatment and injection facilities; oil storage and export facilities; water and wastewater (sewage) treatment plant; and the maintenance workshop.



SURFACE WATER SPECIALIST REPORT

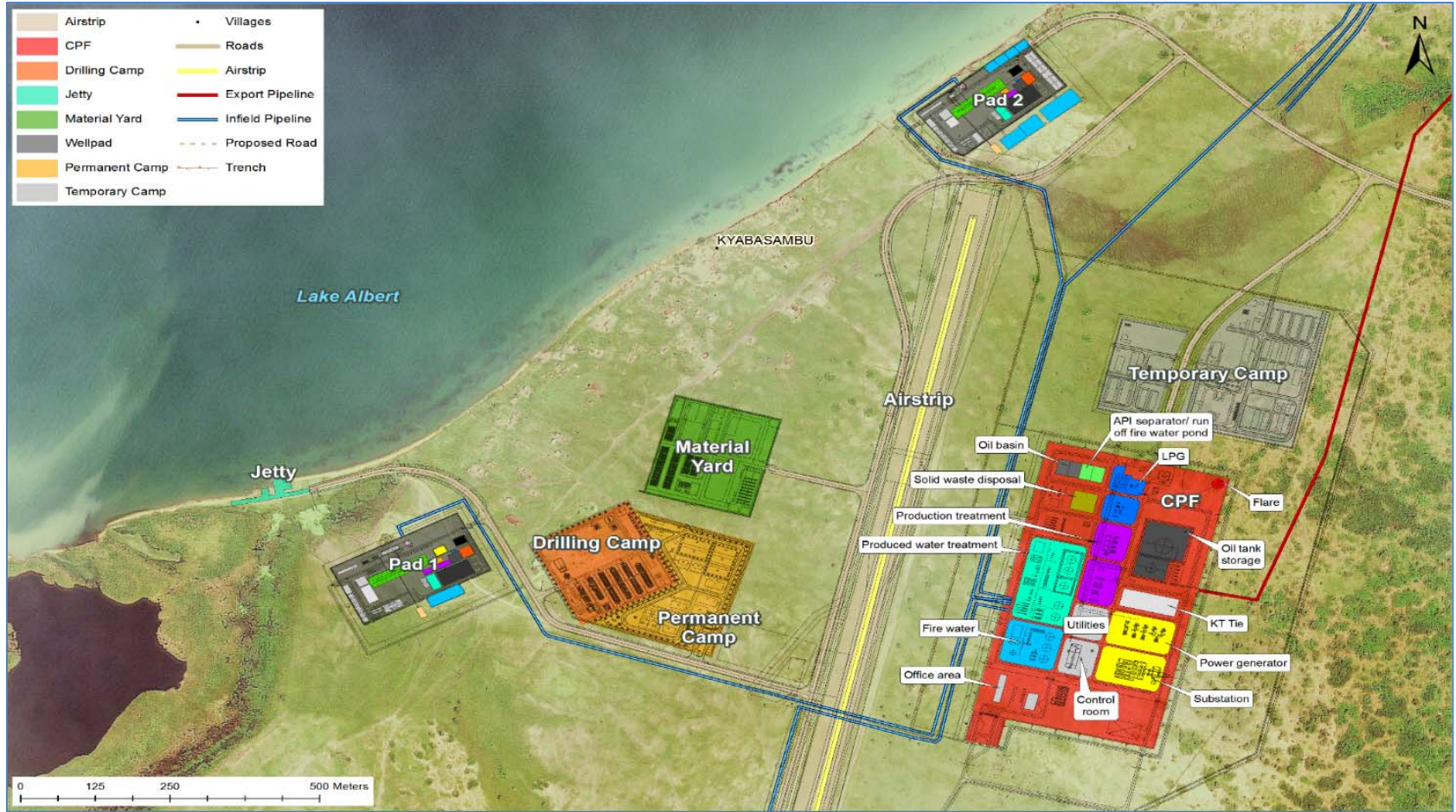

Figure 24: CPF and associated infrastructure





Water Supply

All project water requirements will be supplied from a water intake station on Lake Albert, roughly 1 km northwest of the CPF (Figure 2-4). The final location will be determined during the FEED and will be influenced by the findings of technical studies and the ESIA. A reinforced concrete chamber will be sunk close to the shore edge comprising a pump basin, a silt collection basin and a trash screen section. The depth of the structure will be set to cover the range of design lake water levels and the pump basin depth set to ensure pump performance at the minimum lake level.

Most of the planned intake capacity will be for make-up of produced water injection requirements (further detail on produced water make up is included below). Even in year 25, when produced water generation is high and make up water requirements are at their lowest (56 m³/hr), this demand will still comprise about 89% of the total project water use.

The planned capacity of the intake station is 390 m³/hr, which includes provision for the maximum make-up injection water demand (~301 m³/hr in year 5), potable water demand of 52 m³/d and incidental (unaccounted) water demand, estimated to be in the order of 37 m³/hr, which takes into account water requirements for makeover of wells during operations which is an intermittent activity. The average daily water demand at the CPF, excluding domestic requirements is expected to be approximately 100 m³/day.

Wastewater

The following wastewater streams will be generated at the CPF:

- Produced water - removed from the well fluids and delivered to the water treatment plant before injection down one of 11 injection wells on the well pads;
- Process effluent routed to the Closed Drain system;
- Drainage (mainly storm water) routed to the Open Drain system; and
- Domestic effluent - treated in a sewage treatment plant at the permanent camp.

Figure 27 illustrates the handling of clean and POC water at the CPF.

Produced water

Discharge of produced water outside the boundary of the production facilities will not be considered owing to the sensitivity of the receiving environment. Produced water will be treated to meet the injection water specification, combined with lake water to make up the required quantity, and injected back into the oil reservoir to maintain reservoir pressures. Produced water will increase sharply in the first few years of the project while ramping up to full production in year 6 (415 m³/h). The steep annual increase continues until around year 11 (679 m³/h) after which the curve flattens, and from year 17 onward annual increases in produced water generation are slight. At year 25 end-of-life of the field, produced water reaches a peak of 756 m³/h.

The expected produced water chemistry is set out in Table 11. Table 12 sets out specific requirements that need to be achieved prior to reinjection. These parameters are not measured in the produced water because of the high level at which they would be present or rate of corrosion that they would produce.

Table 11: Properties of CNOOC produced water

Physical Parameters		Anionic Parameters	Concentration (mg/l)	Cationic Parameters	Concentration (mg/l)
pH@25°C (pH units)	7.32	Chloride	3 969	Lithium	0.2
Resistivity @25°C ohm.m	0.805	Sulphate	105	Barium	2.3





Density@20°C (kg/l)	1.004	Bromide	49.8	Strontium	4.7
Elements	Concentration (mg/l)	Nitrate	0.15	Calcium	268
		Phosphate	<1	Magnesium	5.8
		Bicarbonate	257	Sodium	1 724
		Carbonate	0	Potassium	1760
		Hydroxide	0	Iron	<0.5
Total Iron	4.2	Formate	5.2	Copper	<0.5
Phosphorous	<2	Acetate	697	Zinc	2.2
Silicon	27	Propanoate	51	Manganese	0.6
Sulphur	38	Butyrate	20	Aluminium	<1
Total Cl equivalent (mg/l)	4 676	Iso-Valerate	5.7		
Total Na equivalent (mg/l)	3 083	Boron	<3		
Total NaCl equivalent (mg/l)	7 758	Cl: Br	80		
Cation/Anion Balance %	101.67				
Cation/Anion Bias (%)	1.67				

Disposal Standard

The stringent requirement to remove oil from the produced water (Table 12) is mainly to prevent clogging of the injection system. The produced water stripped from the oil in the primary and secondary separators will be delivered to the water treatment plant for further cleaning.

Table 12: Specification for injection of produced water

Specification Unit Value	Unit	Value
Suspended Solids	mg/l	< 5.0
Particle Size	mm	< 3.0
Oil cut	mg/l	< 15.0
Average corrosion rate	mm/a	<0.076
Dissolved Oxygen	mg/l	0.1
Sulphate Reducing Bacteria	unit/ml	25
Ferrobacteria	unit/ml	< n X 10 ³ (1<n<10)
Metatrophic bacteria	unit/ml	< n X 10 ³ (1<n<10)

Produced Water Treatment Plant

The produced water treatment plant will consist of three treatment stages: primary, secondary and tertiary. The specification for produced water quality is stringent, and the basis of design requires a multi staged produced water treatment plant, comprising primary, secondary and tertiary treatment. A number of options have been considered for each stage with the following being selected by the FEED team:

- Skim tanks (Primary treatment). This provides a surge capacity of 4 hours for any upsets in the downstream systems. Skim tanks also ensure coarse separation of oil from water to less than 100 mg/l and TSS to less than 30 mg/l, which is sufficient for secondary and polishing stages of separation.





- Spray-induced gas flotation (Secondary treatment). This treatment system has the advantage of light weight, reduced power consumption, low cost and reliability. Oil in water will be reduced to less than 30mg/l and TSS to less than 20 mg/l.
- Walnut shell filtration (Tertiary treatment). This technology is capable of polishing the water to reliably meeting the 15mg/l oil specification (typically achieve less than 10 mg/l for oil in water and TSS. Five 250 m³/hr filters will be provided, supported by two backwash pumps.
- Provision for an on line oil concentration monitor at the water injection point buffer tank outlet. Provision for other sampling points in the circuit will also be made to monitor oil in water through the treatment system.

Filter aids, reverse demulsifiers and biocides may be added at various points in this treatment process.

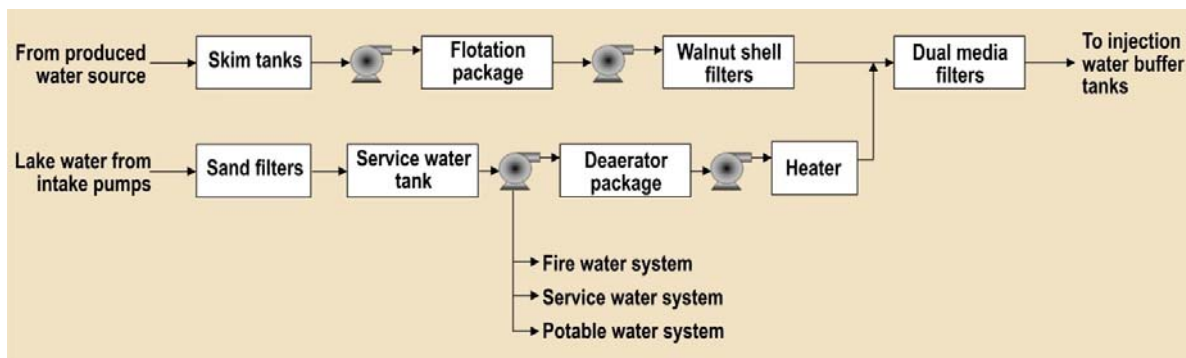

Figure 25: Produced water injection (including make-up water)

Addition of Make-Up Water

The produced water from the CPF will be combined with lake make-up water to meet water injection requirements in the Kingfisher Field (Figure). Lake water will be pumped to the CPF via a dedicated flowline running from the Lake Albert intake facilities. The demand for make-up water will increase sharply up to year 3, to meet the initial shortfall for water injection, after which demand will level off, staying more or less constant until year 9, and then gradual declining. After year 6, the amount of make-up water will be outstripped by produced water generation and by year 25, the usage will only be 34% of the earlier peak requirement, and 7% of the total water injected (Figure 2-6).

At the CPF, the make-up water will be deoxidized by a vacuum deaerator and heated to 87°C. It will then be mixed with the produced water from the walnut shell filters and routed to the dual media filters for fine filtration to reduce TSS to less than 5mg/l, with a particle size average diameter of less than 5 microns.

Backwash Water/ Oil Recovery/ Sludge Disposal

Large quantities of filter backwash water will be generated at the produced water and lake make up water treatment plant.

- The backwash water for the lake water sand filters will be supplied from the service water tank. Dirty backwash water will be discharged into a water recycle tank which is cylindrical, carbon steel tank, designed with a conical bottom to trap sediment. Solids trapped in the bottom will flow into a sludge settling drum for further separation of solids and water. Clarified water will be returned to the inlet of the sand filters. Solids will be drummed and removed by a third party contractor for disposal
- The backwash water for walnut shell filters and dual media filters will be supplied from the water injection buffer tank by backwash pumps. Dirty backwash water will be discharged into a foul water tank. Foul water will be pumped back into the inlet header of the skim tanks.





- Oil skimmed from the skim tanks, flotation vessels, surge tank, walnut shell filters and water injection buffer tanks will be contained in a foul oil recovery drum which will be pumped back to the oil treatment system.
- One sludge settling drum will be provided for the produced water and lake water settled solids. The sludge settle drum will be a vertical cylindrical tank fabricated in lined carbon steel and designed with a conical bottom into which slurry will be discharged from the following sources:
 - water recycle tank conical bottom
 - drain from skim tanks
 - drain from flotation vessels
 - drain from surge tank
 - drain from foul water tank
 - Drain from buffer tanks

The foul oil will be discharged from the sludge settling drum to the sludge dewatering package via a bucket type weir on the side of the drum. Solids will settle in the conical bottom and be discharged by sludge transfer pumps to the sludge dewatering package for further dehydration. Clarified water will be pumped back into the inlet header of the skim tanks by water transfer pumps.

The sludge dewatering package will use a spiral sludge dehydrator which will be fully automatic for easier operation and maintenance, with lower energy consumption and low noise. The effluent through the spiral sludge dehydrator will be pumped back into the inlet header of the skim tanks, while the dewatered sludge will be transferred to the waste disposal areas for disposal by a third party waste contractor.

Storage and Delivery to the Injection Wells

The produced water and make up water will be stored in two 2,000 m³ buffer tanks at the CPF, at a temperature of 80°C. The tanks will have a retention time of 4 hours of storage. Produced water from the tanks will be pressurized by booster pumps (to 199.8 bar) and delivered by flowline to the injectors on the well pads. Provision will be made for dosing with corrosion inhibitor, scale inhibitor, oxygen scavenger and biocide on delivery into the pressurized flowlines to the well pads.

Process Effluent (routed to the Closed Drain System)

Process effluent is generated by equipment operated under pressure, equipment containing toxic fluids and equipment containing highly volatile hydrocarbon liquids which may need to be drained for maintenance or inspection. All of the effluent is route through fully contained closed drains and is either pumped back to the oil processing plant or to the produced water plant.

Potentially oil contaminated (POC) water

Potentially oil contaminated (POC) water will be removed in the open drain system. POC water is managed in three ways (illustrated in Figure 27):

- Open drain system 1 (OD1): from permanently oil contaminated areas during normal operations, or other routine events that could release significant quantities of hydrocarbon liquids. These areas include storm water and wash water collected underneath oil processing equipment likely to produce drips and spillages in routine operations (pumps, compressors, separators, vessels, manifolds, all equipment with non-welded fittings); water collected from beneath oil loading areas; drainage from oil sampling points, water draw off from oil storage tanks, produced water skim tanks, injection water tank bottoms. OD1 effluent is routed through buried pipes to a first flush sump (15 minutes), connected to an oil-water interceptor (example illustrated in Figure 26) for primary treatment and then pumped to the produced water treatment plant for produced water disposal. A maximum 15-minute storm water runoff value of 120 m³ (equivalent to runoff of 478 m³/hr) is provided for. Storm water from this area after the first fifteen minutes will be collected and tested before release into the environment.





- Open drain system 2 (OD2): from accidentally oil-contaminated areas during normal operations, or other routine events that could release very small quantities of hydrocarbon liquids; or areas that are normally clean but could release hydrocarbons as a result of a leak, such as a piping weld puncture or a rare event such as storm flooding and cross contamination of normally clean areas. These areas include storm water collected from paved areas near process units, from bunded areas designed to collect accidental spillages. First flush (15 minutes) OD2 storm water is not discharged directly to the environment – as a minimum, floating oil will be collected from an observation basin and tested before discharge; and
- Open drain system 3 (OD3): from oil-free areas of the plant where the risk of contamination with hydrocarbons or other oily products is negligible and can be disregarded. These areas include undeveloped areas, building roofs and green spaces. OD3 storm water may be discharged directly to the environment through a pipe or ditch without testing.

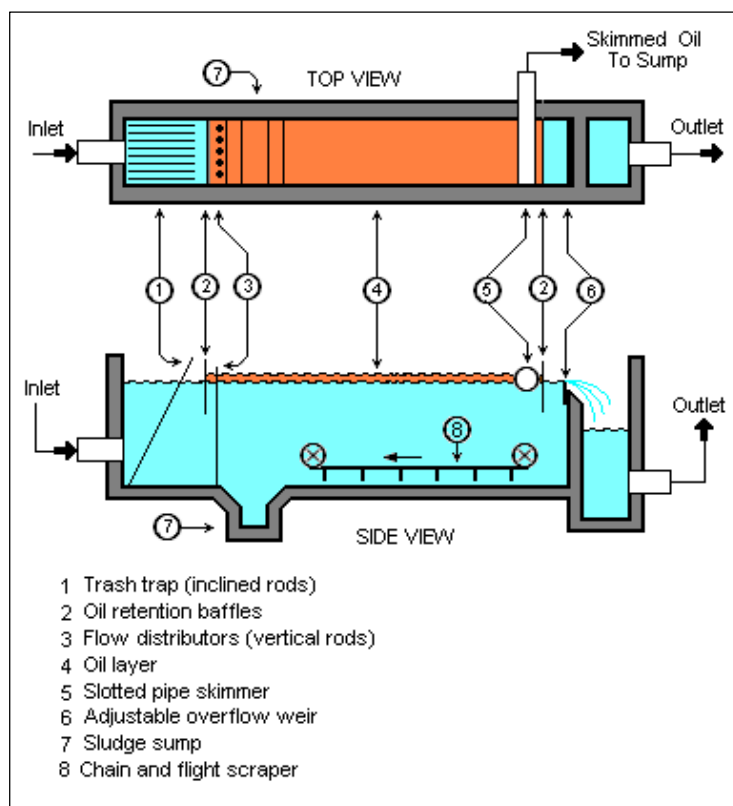

Figure 26: Typical API oil separator (Source: API, 1990)

Laboratory water

Potentially chemically polluted effluent released into the laboratory sinks will be piped into a separate, vented, tank. This will be treated using secondary treatment such as neutralisation; or diluted with water in a controlled manner to prevent hazard to the environment, before release into the open drains (normally the OD 2 drains); or contained in sealed drums, labelled with appropriate hazard warnings and stored for onward transport to a hazardous waste disposal facility.

Storm water impacts from the CPF

Figure 28 illustrates the storm water flow direction and various discharge points and drainage to the lake.



SURFACE WATER SPECIALIST REPORT

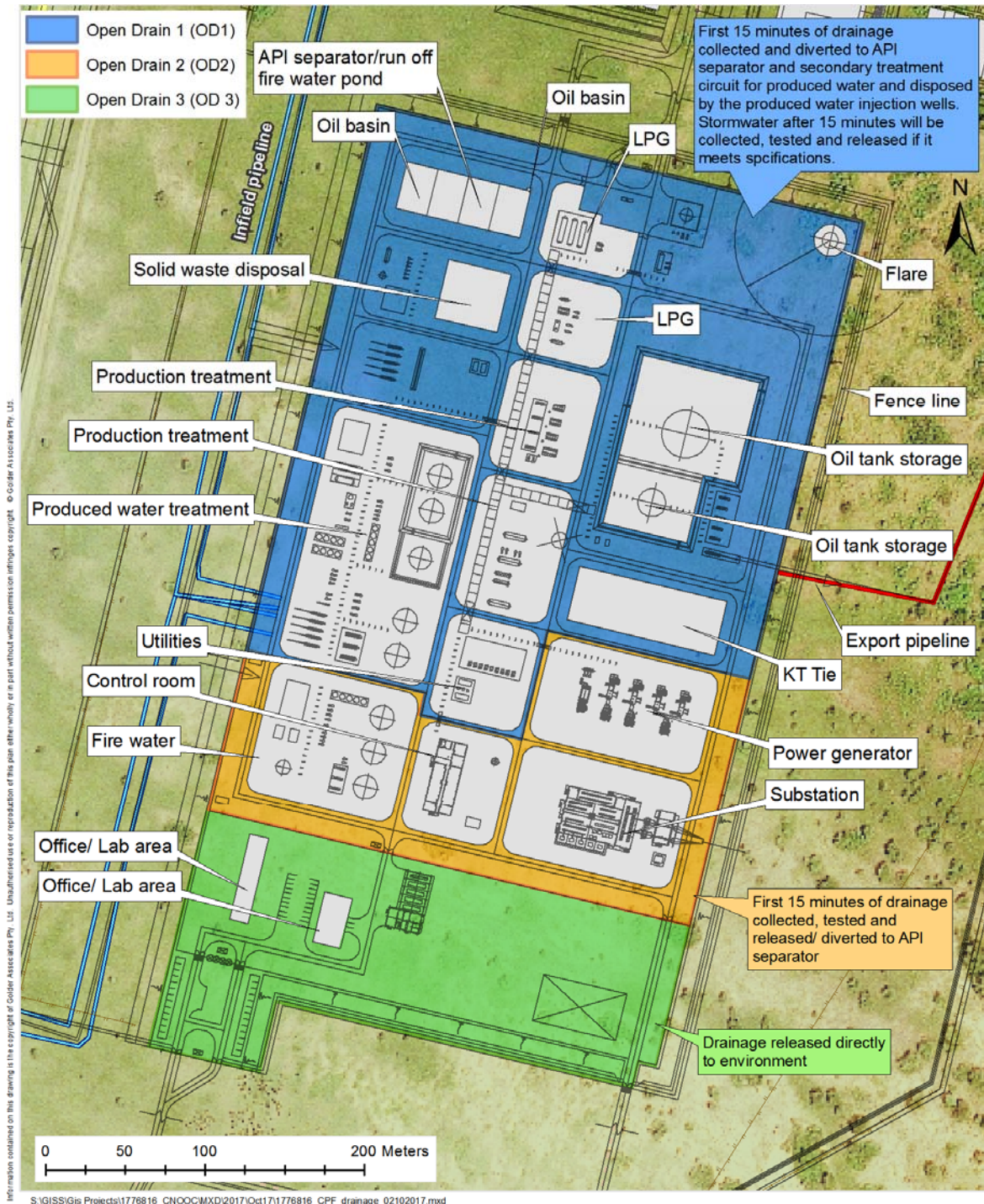

Figure 27: Handling of clean and POC water at the CPF



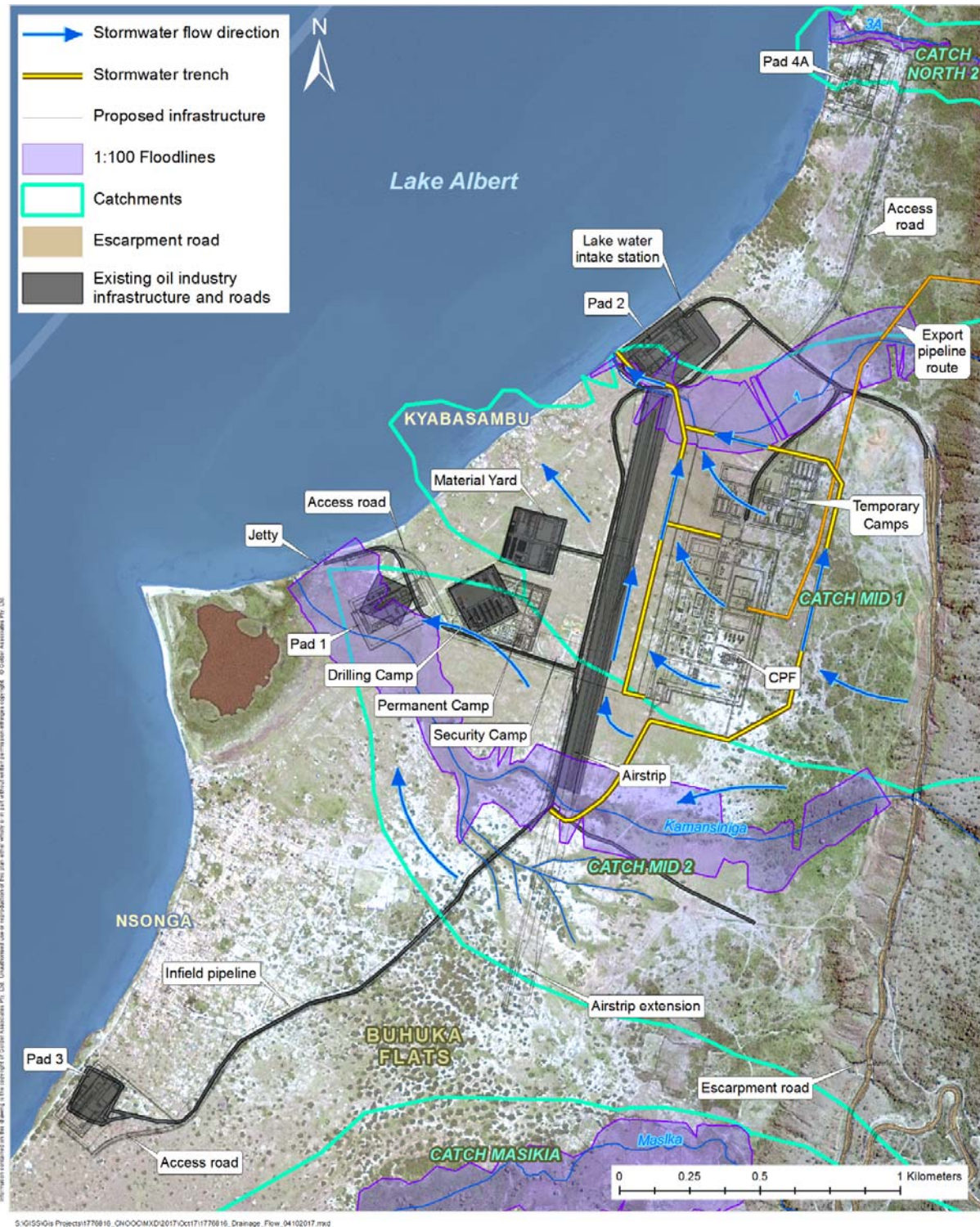

Figure 28: KDA drainage to the lake

Using the floodline model the CPF was divided into a northern (Figure) and southern catchment. The contour elevations fall towards the north-west. Left to its own devices the runoff will channelize parallel to the runway into the stream on the north. The recommendation would be to channelize runoff and pass it under





the runway (Figure). The total flow from the CPF catchment leaves the site at $5.8 \text{ m}^3.\text{s}^{-1}$ with a velocity of $2.7 \text{ m}.\text{s}^{-1}$ in a concrete lined channel with trapezoidal cross-section 1 m deep and 2 m wide at the base. A culvert across the runway conveys the flow 550 mm deep at $0.91 \text{ m}.\text{s}^{-1}$, using 6 x 2 m wide x 1 m high culverts.

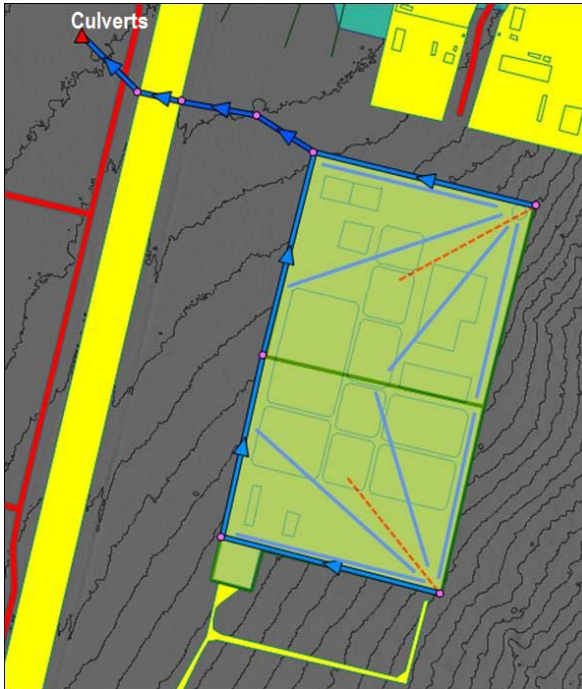

Figure 29: Northern drainage

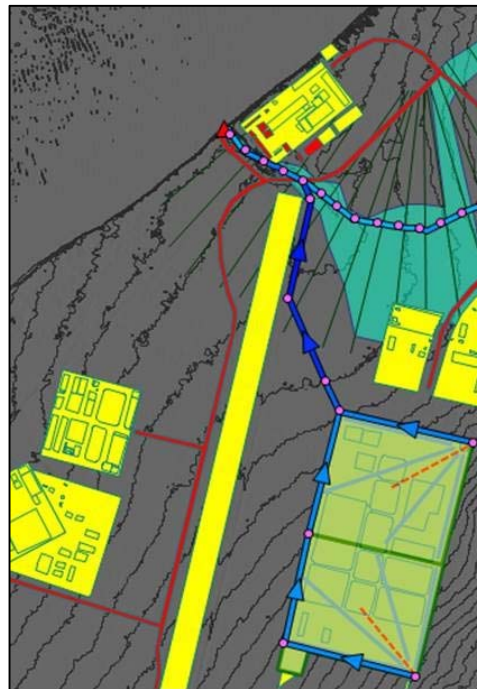

Figure 30: CPF hydrograph

When injecting the flow hydrograph from the entire CPF into the northern stream (considering the 1:100 peaks), the increase in velocity is greater than the sum of their parts, likely because of the channel geometry. The peak flood in the channel from normal runoff is already likely to cause scour at $3.49 \text{ m}.\text{s}^{-1}$ flow velocity. After addition of the CPF runoff hydrograph as per the image in Figure 30, inflow velocity increases to $7.4 \text{ m}.\text{s}^{-1}$ which will cause substantial erosion once in-channel. If a constant inflow of $5.762 \text{ m}^3.\text{s}^{-1}$ at the upstream node (in lieu of the hydrograph, because it will not necessarily be routed as per below) is introduced, the velocity only increases to $5.52 \text{ m}.\text{s}^{-1}$, which is still substantial for an unlined condition and will certainly cause erosion.

Domestic Wastewater

During construction a temporary $300 \text{ m}^3/\text{d}$ Sewage Treatment Plant (STP) will be constructed at the temporary camp and a $50 \text{ m}^3/\text{d}$ plant at the drilling camp. Both of these discharges will enter the lake via drainage line 1, just south of drilling pad 2.

For the operational phase the planned capacity of the domestic wastewater treatment plant (sewage works) is $45 \text{ m}^3/\text{day}$, making provision for an estimated 135 personnel plus contingency. Treated sewage effluent will meet the more stringent of the Ugandan and IFC treated sewage effluent requirements (Appendix 1). The sewage treatment plant will be located at the permanent camp. Backup sewage treatment capability will be provided by the sewage treatment plant built to supply the drilling camp, which has spare capacity for an additional 90 people. The two sewage plants will be linked to allow for maintenance shutdowns of either plant. After drilling is completed in year 6, the drilling sewage plant will be maintained as a backup.

Sewage from the CPF will be routed via conservancy tanks to a regulating tank at the permanent camp from where it will be treated in a Membrane Bioreactor treatment works.



The primary option for final disposal of treated sewage effluent will be by irrigation of the green spaces around the facilities including the camp and the CPF, on roads to suppress dust and also the wider community grazing areas in the Flats. This will be done using 5m³ water trucks fitted with spray / irrigation jets. The backup option will be discharge of the treated domestic wastewater into the channel leading to Lake Albert. Combining the final sewage effluent with the produced water is not a viable option due to the risk of bacterial contamination in the reinjection wells.

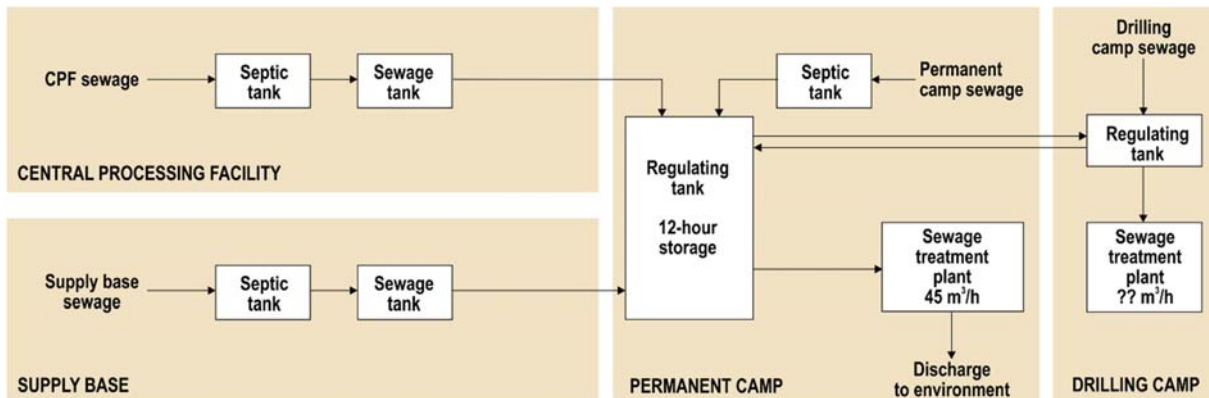

Figure 31: Schematic of sewage treatment capacity for the CPF, supply base and permanent camp

6.1.4 Pipelines

The Kingfisher well fluids, consisting of a mixture of crude, gas and water, will be delivered to the CPF via buried flowlines from each of the four well pads.

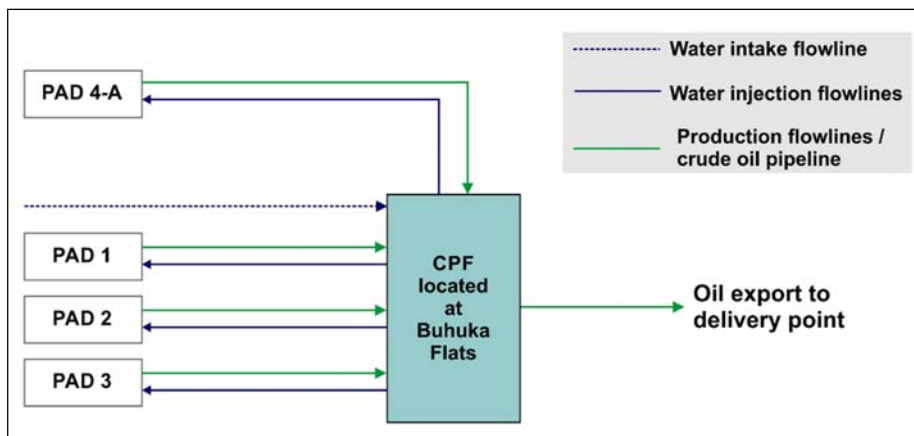

Figure 32: Schematic of production and water injection flowlines

The flowlines will cross minor drainage lines from the escarpment near Pad 2 and south of the airstrip en route to Pad 3. The flowlines will be buried beneath the maximum scour depth of the river course as illustrated in Figure 33. The flowlines will be rated to cater for overpressure conditions.

Soil tests in the Bugoma flats show moderate to high corrosivity. The outer surface of the flowlines is likely to be encased in an FBE coating in order to inhibit corrosion. Welded joints will be protected using a heat shrink wrap sleeve, applied after the weld is completed.

An impressed current Cathodic Protection System will be used to apply a small electrical current to the metal surface of the pipeline. Combined with a sacrificial anode, this minimises external corrosion of the pipe. There is no risk to humans or animals caused by the system. Taking into account current methods of pipe





manufacture, pipeline construction and maintenance and cathodic protection, the design life of a pipe buried according to these specifications is likely to exceed 30 years.

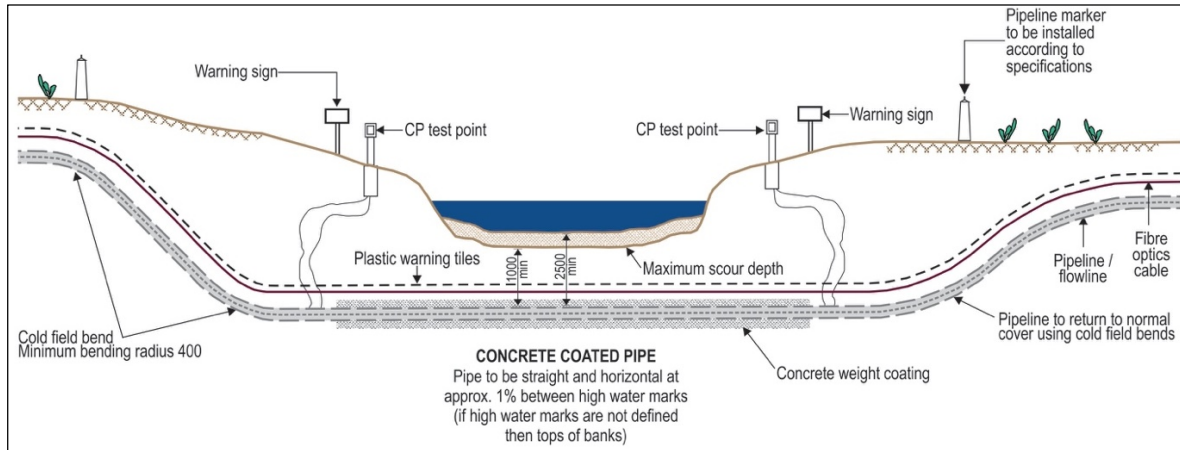

Figure 33: Cross section of a flowline crossing of a typical drainage line

The flowlines require little maintenance on a day to day basis. The right of way will be monitored regularly for any signs of human activity (for example, excavation) that could create a risk, and for any leaks. A major flowline failure would be picked up by a pressure drop in the line, recorded in the control room at the CPF. Minor leaks would typically manifest as a small patch of dying vegetation at the surface. In some instances, leaks can be heard and are reported by third parties. Leaks are very rare.

The main surface water concerns are therefore related to potential leaks from the pipeline at surface water crossings.

6.2 Impact Assessment Methodology

The impact assessment process compares the magnitude of the impact with the sensitivity of the receiving environment. This method relies on a detailed description of both the impact and the environmental or social component that is the receptor. The magnitude of an impact depends on its characteristics, which may include such factors as its duration, reversibility, area of extent, and nature in terms of whether positive, negative, direct, indirect or cumulative.

Once the magnitude of the impact and the sensitivity of the receiving environment have been described, the severity of the potential impact can be determined. The determination of significance of an impact is largely subjective and primarily based on professional judgment.

To provide a relative illustration of impact significance, it is useful to assign numerical descriptors to the impact magnitude and receptor sensitivity for each potential impact. Each is assigned a numerical descriptor of 1, 2, 3, or 4, equivalent to very low, low, medium or high. The significance of impact is then indicated by the product of the two numerical descriptors, with significance being described as negligible, minor, moderate or major, as in Table 13. This is a qualitative method designed to provide a broad ranking of the different impacts of a project.



Table 13: Determination of impact severity

			Sensitivity of receptor			
			Very low	Low	Medium	High
			1	2	3	4
Magnitude of Impact	Very low	1	1 Negligible	2 Minor	3 Minor	4 Minor
	Low	2	2 Minor	4 Minor	6 Moderate	8 Moderate
	Medium	3	3 Minor	6 Moderate	9 Moderate	12 Major
	High	4	4 Minor	8 Moderate	12 Major	16 Major

Table 14: Impact assessment criteria and rating scale

Criteria	Rating scales
Magnitude (the expected magnitude or size of the impact)	Negligible - where the impact affects the environment in such a way that natural, and /or cultural and social functions and processes are negligibly affected and valued, important, sensitive or vulnerable systems or communities are negligibly affected.
	Low - where the impact affects the environment in such a way that natural, and/or cultural and social functions and processes are minimally affected and valued, important, sensitive or vulnerable systems or communities are minimally affected. No obvious changes prevail on the natural, and / or cultural/ social functions/ process as a result of project implementation
	Medium - where the affected environment is altered but natural, and/or cultural and social functions and processes continue albeit in a modified way, and valued, important, sensitive or vulnerable systems or communities are moderately affected.
	High - where natural and/or cultural or social functions and processes are altered to the extent that they will temporarily or permanently cease, and valued, important, sensitive or vulnerable systems or communities are substantially affected. The changes to the natural and/or cultural / social-economic processes and functions are drastic and commonly irreversible
Sensitivity of the Receptor	Low – where natural recovery of the impacted area to the baseline or pre-project condition is expected in the short-term (1-2 years), or where the potentially impacted area is already disturbed by non-project related activities occurring on a scale similar to or larger than the proposed activity
	Medium – where natural recovery to the baseline condition is expected in the medium term (2-5 years), and where marginal disturbance or modification of the receiving environment by existing activities is present.
	High – where natural recovery of the receiving environment is expected in the long-term (>5 years) or cannot be readily predicted due to uncertainty over the nature of the potential impact, and where unique or highly valued ecological, social or cultural resources could be adversely affected.





6.3 Construction and decommissioning phase impacts

The anticipated impacts are expected to be similar for both the construction and decommissioning phases, and will occur over a similar period of approximately 2 years. Therefore, for the intents of this impact assessment, the decommissioning phase impacts have been included with the construction phase impacts in their assessment.

This section presents an assessment of the possible interactions of the drainage lines and rivers with the production facility infrastructure and activities including the camps, well pads and Central Processing Facility, as well as the pipelines; and the resulting impacts during the construction and decommissioning phases of the Project.

The predicted impacts on the surface water environment can be broadly categorised as:

- Impacts on water quality:
 - Sedimentation due to erosion;
 - Pollution from spillages; and
 - Discharge of poorly treated domestic wastewater.
- Impacts on/ from water quantity:
 - Disturbance of the flow lines in the Buhuka Flats;
 - Inadequate storm water management
- Impacts on the bed and banks of rivers/ streams:
 - Pipeline crossings; and
 - Construction activities in rivers/ streams.

The potential impacts of the project during the construction and decommissioning phase are listed and ranked in Table 15 and discussed in the sections to follow.

Table 15: Potential impacts in the construction and decommissioning phase

No.	Potential Impact	Pre-Mitigation			Post- Mitigation		
		Magnitude (the expected magnitude or size of the impact)	Sensitivity of the Receptor	Severity	Magnitude (the expected magnitude or size of the impact)	Sensitivity of the Receptor	Severity
C1	Increased erosion and runoff volumes	Medium	Medium	Moderate	Low	Low	Minor
C2	Increased dust and sedimentation in drainage streams	Medium	Low	Moderate	Low	Low	Minor
C3	Altering the banks and beds of streams by the construction of the pipeline	Medium	Low	Moderate	Low	Low	Minor





No.	Potential Impact	Pre-Mitigation			Post- Mitigation		
		Magnitude (the expected magnitude or size of the impact)	Sensitivity of the Receptor	Severity	Magnitude (the expected magnitude or size of the impact)	Sensitivity of the Receptor	Severity
C4	Spillage of oils, fuel and chemicals polluting water resources	Medium	High	Major	Low	Medium	Moderate
C5	Discharge of poor quality effluent from the sewage works at the temporary camp	Medium	Low	Moderate	Low	Low	Minor

6.3.1 Increased erosion and runoff volumes

Impact Assessment

Due to the expansive network of drainage lines on the Buhuka Flats (Figure 23) the removal of vegetation and topsoil for the construction of the infrastructure, as well as the compaction of surfaces during construction, will result in increased runoff and erosion from the site, particularly given the steep slopes leading into the Flats from the escarpment and high rainfall in the area. Sediment generated during construction of the CPF itself and other onshore infrastructure will enter the lake during storm flows over the approximately three year construction period, peaking during site establishment when vegetation is being cleared and civil earthworks is ongoing.

The soils of the Buhuka Flats are dispersive (Golder Associates 2014d), and cleared areas will be prone to scour, and high sediment loads may be expected. River 1, which flows north of the temporary camps and proposed CPF, is likely to receive the drainage from the CPF earthworks and temporary camp. Additional sediment will also be contributed from the expansion of well pad 2 to its full size. While the materials yard falls within River 1 catchment, its construction activities are likely to impact Lake Albert directly.

The sediment from the construction activities at the permanent camp are likely to impact the Kamansiniga River, South of the CPF, and potentially also the lake directly. This river, as well as the papyrus lagoon (Luzira) and lake, will also be impacted by any construction activities at Pad 1 (Figure 34). The Luzira is an important area as it is an active place of worship and the historic center of cultural activity. The biodiversity study (Golder Report number: 1776816_D.0) has however indicated that the seasonal wetland will provide efficient attenuation of sediment, and a significant increase in sediment concentrations in the lake or in the lagoon are unlikely.

While the water courses of the study area support dense emergent vegetation that will assist in reducing flow velocities and sediment, it is still expected that increased turbidity will be measurable in the nearshore environment during and after storms, where the rivers discharge into the lake, and specifically at River 1 where there are no attenuating wetlands.





Figure 34: Likely drainage path to the Papyrus Lagoon

Impact Classification

The impacts caused by erosion and sedimentation on the rivers, lake and lagoon are expected to be mostly on River 1 where no wetland attenuation can be expected and the largest load will report to, although there is likely to be some impact on the Kamansinga River, Luzira and Lake Albert directly. It has been scored with a medium magnitude where the affected environment is altered but natural, and/ or cultural and social functions and processes continue albeit in a modified way, and valued, important, sensitive or vulnerable systems (such as the Luzira) or communities are moderately affected. The sensitivity of the receptor has been scored as medium where natural recovery to the baseline condition is expected in the medium term (2-5 years), and where marginal disturbance or modification of the receiving environment by existing activities is present.

The **impact severity** is therefore scored as **moderate**, as the impacts can be reversed however may take some time.

Mitigation

Mitigation should include:

- Limiting the area that is cleared at all the sites where additional construction may occur (expansion of well pads, materials yard and camps), and specifically the proposed CPF area which is yet to be constructed;
- At all sites, ensuring that soil is not placed where it can easily be washed in to the river;
- Construction and maintenance of storm water channels/ trenches around the sites so that sediment is collected as far as possible on the site and stored in sediment control dams prior to release. The dams will allow the sediment to settle prior to discharge of runoff to the environment. It is recommended that





the storm water from around the CPF is channelled under the runway to prevent scour that would very like occur if all the water was to exit to the river at the run-way.

- Construction of a storm water management berm system on the perimeter of each development area so that clean storm water run-off is directed away from the site.

Should erosion and sediment control mitigation be put in place, the **impact severity** could be reduced to a **minor**, as the majority of sediment would not reach the rivers, lagoon or lake in one flush.

6.3.2 Increased dust and sedimentation in drainage streams

Impact Assessment

The removal of vegetation and topsoil, as well as the movement of vehicles during construction, specifically during construction of the CPF, and expansion of the well pads will result in increased dust levels and further sedimentation in the surface waters near the Kingfisher Development Area. This may result in an increase in sediment load in the runoff reporting to the rivers and Lake Albert, as described in Section 6.3.1.

Impact Classification

It is expected that the impact would have a medium magnitude where where the affected environment is likely to be altered but natural, and/ or cultural and social functions and processes (specifically at the Luzira) will continue, and valued, important, sensitive or vulnerable systems or communities are moderately affected.

The sensitivity of the receptor however has been scored as low, where natural recovery of the impacted areas to the baseline or pre-project condition is expected in the short-term (1-2 years) as cleared areas are revegetated and buildings are erected.

The **impact severity** is therefore scored as **moderate**, as the impacts will still be of medium magnitude, however, can be reversed within a fairly short (1-2 year period).

Mitigation

Mitigation should include:

- Dust suppression using biodegradable chemicals or water abstracted from Lake Albert during the construction phase;
- Avoidance of construction activities during times when the communities may be holding the rituals/ cultural activities to lessen the dust at a specific time.

Implementing mitigation should reduce the impact to low magnitude where the impact is likely to affect the environment in such a way that natural, and/or cultural and social functions and processes are minimally affected and valued, important, sensitive or vulnerable systems or communities are minimally affected. In this respect no obvious changes will prevail on the natural, and/ or cultural/ social functions/ processes as a result of project implementation and sensitivity, so that an overall minor impact significance is recorded. The sensitivity of the receptor will remain low where natural recovery of the impacted areas to the baseline or pre-project condition is expected in the short-term (1-2 years) as cleared areas are revegetated and buildings are erected.

The **impact severity** is therefore reduced to minor.

6.3.3 Altering the banks and beds of streams due to excavation for infield and export pipelines

Impact assessment

The construction of the pipeline crossings may alter the river banks and bed. While the pipeline will be below ground, there is the potential for erosion at the excavation site when digging the trench for the flowline. This may have impacts downstream of the crossings, backwater upstream of the crossings during the excavation when water cannot flow through, and erosion once the water in the rivers starts to flow again. This will have direct impacts on the lake between Pads 3A and 2 and River 1 where trenching would need to take place to





lay the infield flowlines; as well as the Hohwo and Ngema rivers which are crossed by the export pipeline at about 27 and 35 kilometres respectively.

Impact Classification

The impact on the drainage lines and River 1 where the infield pipeline from Pad 3A connects to the line at Pad 2 would have a medium magnitude and low sensitivity, resulting in a **moderate impact severity** during construction.

The reason being that the affected environment would be altered during the trenching activity, however natural, and/or cultural and social functions and processes would continue and natural recovery of the impacted area to the baseline or pre-project condition is expected in the short-term (1-2 years).

Similarly the impact on the Hohwo and Ngema rivers by the excavation for the export pipeline is also expected to result in a **moderate impact severity** during construction, as the impacted areas would be of short duration.

Mitigation

The protocols to be applied while constructing the crossings should be developed and documented in the Environmental Management Plan (EMP). The mitigation needs to include:

- Excavating during times when high rainfall is not expected to limit wash down of excavated material into the lake and rivers, and to limit the volume of water that will need to be dammed to allow the trench to be dug and the pipes laid;
- Rehabilitation of the bed and banks of the river as soon as the pipe has been laid ensuring that the compaction is adequately done to avoid scour as water flow commences.

Implementing mitigation will reduce the impact to low magnitude and sensitivity with an overall **minor impact severity** because the risk of soils being washed down will be limited,

6.3.4 Spillage of oils, fuel and chemicals polluting water resources

Impact Assessment

Small quantities of oil and chemicals from vehicles and other mechanical equipment during construction into storm water draining from construction areas could increase the concentrations of these pollutants in River 1 and consequently in Lake Albert south west of well pad 2, as well as to a lesser extent into the Kamansing River. In the day to day construction activities this is considered to be likely, although concentrations should be low. In addition the contamination will be short term over a small geographical area in the near-shore environment. Minor spillages and rain wash from oily construction equipment that is working on the jetty and water intake station may also contribute to pollution loads in these areas, particularly as the deposition would be directly into the near-shore lake environment.

Impact Classification

The overall magnitude is considered to be medium where the affected environment will be slightly altered and the natural and cultural activities of the communities in the sensitive areas are expected to be marginally impacted in most cases.

However, a further and more severe risk will result from the construction and drilling of the wells. While control systems are proposed to manage contaminated storm water and wash water from the well pads, the presence of drilling crews on site for nearly a year using potentially hazardous drilling fluid; and the absence of a buffer between the well pads and the lake (and in the case of well pad 1, the seasonal wetland and the lagoon); makes it likely that occasionally contaminated drainage will reach the lake unless there is a very high level of control of day to day activities.

This must be assessed in the context of the sensitivity of the near-shore environment to oil and chemical spills. The concentration of hydrocarbons and other pollutants in the lake water is currently below levels that could cause harm in the lake environment (Golder Associates 2014b), however in the absence of mitigation,





the overall impact severity of chemical and oil pollution to Lake Albert may be **major**, where natural and/or cultural or social functions and processes are altered to the extent that they will temporarily or permanently cease while for example, a spill is cleaned up resulting in a medium rated magnitude and the sensitivity of the receptor is rated as high, where natural recovery of the receiving environment is expected in the long-term (>5 years) however, cannot be readily predicted due to uncertainty over the nature of the potential impact, and where unique or highly valued ecological, social or cultural resources (The Luzira) could be adversely affected.

Mitigation

The protocols that should be applied during the construction phase should be developed and documented in the EMP. The protocols should address the following:

- Compliance to the requirements of the Ugandan National Environment (Waste Management) Regulations, S.I. No 52/1999 or other relevant International Waste guidelines;
- Storage of new and used oils in demarcated bunded areas;
- Storage of other hazardous or toxic substances securely and controlled use thereof;
- The construction of covered drilling waste pits to contain hazardous waste prior to collection for safe disposal at a certified hazardous waste facility;
- Construction of an evaporation pond at each well pad to contain the liquid drilling wastes; and associated dewatering pumps to pump liquids for safe disposal by a certified hazardous waste contractor at a certified hazardous waste facility;
- No co-handling of reactive liquids or solids;
- Creation and monitoring of an inventory of chemicals held on site;
- Availability and accessibility of HAZOP sheets of all chemicals; and
- The immediate clean-up of spills and temporary storage at the CPF of any hazardous material before being disposal by a certified hazardous waste contractor.

If the recommended construction protocols are followed, then impact during construction will be reduced to low magnitude and medium sensitivity, with an overall **moderate severity**.

6.3.5 Discharge of poor quality effluent from the sewage works at the temporary camp

Impact Assessment

During construction a temporary 300 m³/d Sewage Treatment Plant (STP) operate at the temporary camp and a 50m³/d plant at the drilling camp. Both of these discharges will enter the lake via drainage line 1 (probably canalised), just south of drilling pad 2. Should poor quality effluent be discharged to the environment this may have an impact on the ecosystems as well as human health.

Impact Classification

The impact is rated with a medium magnitude where the affected environment is altered because of specific impacts related to bacterial contamination. The receptor sensitivity is recorded as low as the natural recovery of the impacted area to the baseline or pre-project condition is expected in the very short-term, resulting in a **moderate** impact severity.

Mitigation

The treatment process needs to be of a type that will meet the Uganda and IFC standards in terms of BOD, N, P and SS. Chlorine should be considered as a disinfection step, either in tablet form (1st choice due to stability and ease of transport) or in solution form (2nd choice since sodium hypochlorite loses efficiency with storage duration). Gaseous disinfection is not recommended due to the potential explosive safety risks.





It is recommended that the effluent be irrigated rather than discharged directly back into a water resource, or a man-made wetland be constructed upstream of the discharge to act as a buffer.

Treated sewage effluent would need to comply with the values set out in Table 16.

Table 16: Treated sewage effluent discharge limits (EFC standards)

Variable	Guideline Value
pH	6 – 9
BOD mg/l	30
COD mg/l	125
Total nitrogen mg/l	10
Total phosphorus mg/l	2
Oil and grease mg/l	10
Total suspended solids mg/l	50
Total coliform bacteria MPN/ 100 ml	400

Notes: MPN = Most Probable Number

If the recommended construction protocols are followed and the systems are maintained, then impacts during construction will be reduced to low magnitude and sensitivity, resulting in an overall **moderate** impact severity.

6.4 Operational phase

The potential impacts during the operational phase identified for the surface water study are presented in Table 17.

Table 17: Potential impacts related to the Operational phase

No.	Potential Impact	Magnitude (the expected magnitude or size of the impact)	Sensitivity of the Receptor	Severity	Magnitude (the expected magnitude or size of the impact)	Sensitivity of the Receptor	Severity
O1	Reduction in catchment area	Low	Low	Minor	Very Low	Very Low	Negligible
O2	Increased erosion, dust and sedimentation	Low	Low	Minor	Very Low	Very Low	Negligible
O3	Discharge of poor quality storm water from CPF	Medium	High	Major	Low	Medium	Moderate
O4	Spillage of crude oil from Well pads and CPF	Medium	High	Major	Low	Low	Minor
O5	Infrastructure crossing natural drainage lines	Medium	High	Major	Low	Low	Minor
O6	Oil leaks around pipeline	Medium	High	Major	Low	Medium	Moderate





No.	Potential Impact	Magnitude (the expected magnitude or size of the impact)	Sensitivity of the Receptor	Severity	Magnitude (the expected magnitude or size of the impact)	Sensitivity of the Receptor	Severity
O7	Rise in water level of Lake Albert	High	High	Major	Low	Medium	Moderate
O8	Decrease in Lake Albert levels	Very low/negligible	High	Minor	Very low	Very Low	Negligible
O9	Discharge of poor quality effluent from the sewage works at the CPF (permanent camp)	Medium	Low	Moderate	Low	Low	Minor

6.4.1 Catchment reduction

Impact Assessment

The infrastructure development at the Kingfisher Development Area will only marginally reduce the runoff volume reporting to the local streams. The major rivers reporting to the lake will not be impacted in respect of reduced flow. The drainage lines will be impacted by the construction of the CPF and the well pads, however the storm water that would report via the drainage lines to the lake, will now be channelled around the CPF and well pads and other infrastructure to either River 1 or to Kamanasinig River, so that the volume of water reporting to the lake will only be marginally reduced. There is however the concern that the storm water emanating from the site may be slightly polluted so some volume may be lost as the water will first pass through sediment control dams, sediment traps or oil and grease traps before the water can be released to the environment.

The infrastructure will be required to stand at a raised elevation from the actual ground level due potential flooding over the Buhuka Flats, which will reduce the impact on the runoff volumes.

Impact Classification

The impact has been ranked with a low magnitude which means that the impact affects the environment in such a way that natural, and /or cultural and social functions and processes are negligibly affected, and valued, important, sensitive or vulnerable systems or communities are negligibly affected. In this respect the receptor sensitivity is also rated as low as there is almost no impact to the lake. This relates to an overall **minor** impact severity.

Mitigation

The storm water that is potentially contaminated on the site infrastructure areas, will be collected by the storm water channels and channelled to sediment control dams, sediment traps or oil and grease traps before the water can be released to the environment, if it meets the Uganda Standards as discussed under section 6.4.3. This will result in minimal impact on the natural runoff volumes, without contaminating the surface water.

With mitigation, the impact will be reduced to a negligible magnitude, very low sensitivity, and **negligible** impact severity.





6.4.2 Erosion, dust and sediment collection

Impact Assessment

With open roads and removal of vegetation around the Kingfisher Development Area and along the access road that runs parallel to the export pipeline to Kabaale, there could be an increase in erosion and dust leading to an increase in sedimentation in the runoff water. This could result in a deterioration of land capability and increased sediment loading in the natural water courses. Erosion around cleared areas around the site could lead to the accumulation of sediment upstream of the points where the infrastructure crosses the drainage paths. It is however expected that those areas that are cleared of vegetation during the construction phase and where no infrastructure is located, will have been revegetated. The dust and erosion is therefore likely to be mostly along the access road, so will be limited.

Impact Classification

During the operational phase it is expected that those areas that are cleared of vegetation during the construction phase and where no infrastructure is located, will have been revegetated so that erosion will be limited and sedimentation impacts will decrease compared to that of the construction phase.

The impact has therefore been ranked with a low magnitude which means that the impact affects the environment in such a way that natural, and /or cultural and social functions and processes are negligibly affected, and valued, important, sensitive or vulnerable systems or communities are negligibly affected. In this respect the receptor sensitivity is also rated as low as there is almost no impact to the lake. This relates to an overall **minor** impact severity due to dust and erosion leading to sedimentation during the operational phase.

Mitigation

Dust suppression along the access road would reduce the excess dust that might contribute to sedimentation. The dust suppression methods should be limited to using bio-degradable, eco-friendly suppression chemicals or water extracted from Lake Albert. Effective storm water management measures will be installed as mentioned previously to separate dirty areas. Sediment traps should also be installed where appropriate to allow for flow of water while preventing the accumulation of sediment when the water is released from site.

With mitigation, the impact will be reduced to a negligible magnitude, very low sensitivity, and **negligible** impact severity.

6.4.3 Discharge of poor quality storm water

Impact Assessment

Potentially Oil Contaminated (POC) storm water generated in the defined hazardous areas of the plant will be collected in the open drain system for delivery to an API oil separator. API separators are designed to separate gross amounts of oil and suspended solids from the water. The first 15 minutes of any storm will be captured and routed through the API separator before being delivered to the secondary treatment section of the produced water treatment system for further treatment and disposal with produced water. A maximum 15-minute storm water runoff value of 120 m³ (equivalent to runoff of 478 m³/hr) is provided for. The balance of any storm water will be captured in a storm water pond, tested and released into the environment, if it meets the discharge specification. All storm water from designated non-hazardous areas of the plant will be released directly from the open drains, without testing.

Clean storm water will be kept separate from potentially oil contaminated water in order to reduce the volume of wastewater to be treated prior to discharge. Storm water upslope of the plant will be diverted around it. Storm water from clean areas of the plant such as building roofs or roads will be allowed to soak-away or be reused as a resource, where possible.

Chemical and other potential small spillages will be contained in the closed drain system, collected, drummed and disposed by an accredited hazardous waste contractor appointed to manage transport and disposal of wastes leaving the site.





Poor quality storm water released to the environment could have a significant impact on the aquatic ecosystems health in the wetland as well as lake areas, and particularly in the Luzira area, and if left unchecked could have human health impacts.

Impact Classification

The overall magnitude is considered to be medium where the affected environment will be slightly altered and the natural and cultural activities of the communities in the sensitive areas are expected to be marginally impacted in most cases.

This must be assessed in the context of the sensitivity of the near-shore environment to oil and chemical spills. The concentration of hydrocarbons and other pollutants in the lake water is currently below levels that could cause harm in the lake environment (Golder Associates 2014b), however in the absence of mitigation, the overall impact severity of chemical and oil pollution to Lake Albert may be **major**, where natural and/or cultural or social functions and processes are altered to the extent that they will temporarily or permanently cease while for example, a spill is cleaned up resulting in a medium rated magnitude and the sensitivity of the receptor is rated as high, where natural recovery of the receiving environment is expected in the long-term (>5 years) however, cannot be readily predicted due to uncertainty over the nature of the potential impact, and where unique or highly valued ecological, social or cultural resources (such as the Luzira) could be adversely affected.

Mitigation

The storm water management system in place, including oil separators, needs to be optimally operated and maintained to ensure that water released to the environment has an oil and grease content of less than 10 mg/L.

Water released to the environment should be analysed for TDS, oils and grease and in the event that this water does not meet the discharge standards for TDS or oil and grease, additional treatment will be required before this water can be released.

Implementation of these measures would mean that the magnitude would be reduced to a low rating and the sensitivity of the receptor to a medium. The overall impact severity would be **moderate**.

6.4.4 Crude oil spills

Impact assessment

Simultaneous production and drilling on the well pads will occur for the first 7 years, until the project reaches full production. The design will allow for the drilling rig to move between different slots without shutting down production on the well pad.

In order to handle oily drainage from pipelines and equipment, each well pad will be provided with an underground closed drain system leading to a sump with a submersible pump. The levels will be monitored, and the sump periodically emptied into a mobile tanker for handling at the CPF.

Only small quantities of solid waste will be generated, once drilling is completed. The wells are unmanned and will be remotely operated from the CPF over extended periods, without intervention on the well pad. During maintenance, small quantities of potentially oil contaminated and non-hazardous waste will be generated. These will be separated into non-hazardous and hazardous components, delivered to the CPF for temporary storage and then recycled, where possible, or earmarked for disposal by a certified hazardous waste contractor. CNOOC indicates that NORM is not expected in the pigging wastes. Estimated quantities of potentially hazardous waste are less than 0.5 t/well/year.

During the operational phase, oil spills at the wells, as well as spillage of other on-site chemicals, could result in the pollution of water resources if the spill is not contained or the sump is not well maintained and emptied adequately.





Impact Classification

While control systems are proposed to manage contaminated storm water and wash water from the well pads, the presence of drilling crews on site when drilling is taking place at a particular well pad, using potentially hazardous drilling fluid; and the absence of a buffer between the well pads and the lake (and in the case of well pad 1, the seasonal wetland and the lagoon); makes it likely that occasionally contaminated drainage will reach the lake unless there is a very high level of control of day to day activities.

The concentration of hydrocarbons and other pollutants in the lake water is currently below levels that could cause harm in the lake environment (Golder Associates 2014b), however in the absence of mitigation, the overall impact severity of chemical and oil pollution to Lake Albert may be major, where natural and/or cultural or social functions and processes are altered to the extent that they will temporarily or permanently cease while for example, a spill is cleaned up resulting in a medium rated magnitude and the sensitivity of the receptor is rated as high, where natural recovery of the receiving environment is expected in the long-term (>5 years) however, cannot be readily predicted due to uncertainty over the nature of the potential impact, and where unique or highly valued ecological, social or cultural resources (such as the Luzira) could be adversely affected.

This will result in a medium magnitude and high receptor sensitivity, an overall major significance.

Mitigation

Measures for containment of oil spills and warning systems for leaks must be included in the design of the abstraction wells. The protocols that should be applied in the event of an oil spill in the operational phase should be developed and documented in the EMP and maintenance of the control systems must be done so that all aspects remain optimal. A clean-up plan should be prepared and carried out in this event. No contaminated storm water should be released from the well pads due to their proximity to the lake. All contaminated water should be pumped and contained at the CPF until collected by an accredited waste removal contractor for safe disposal at an accredited hazardous waste site.

After mitigation the impact severity decreases to moderate, based on a low magnitude and medium receptor sensitivity.

Closely related to both discharge of poor quality storm water and crude oil and other chemical spills, is the aspect of surface water monitoring. In this respect other contaminants of concern (associated with crude oil production), listed in Table 18 should be measured in samples from all the surface water sampling points indicated in Table 3 on a monthly basis, as well as at sites identified in Lake Albert. Monitoring will allow trends to be developed so that additional mitigation can be implemented as necessary to limit impacts to human and aquatic ecosystems health.

Table 18: Variables to be measured for surface water

Table with 4 columns: Variable, Unit, Variable, Unit. Lists various pollutants like pH, Total Suspended Solids, Nitrogen, Aluminium, Arsenic, Cadmium, Chromium III, Chromium VI, Copper, Lead, Mercury, Manganese, Zinc, Total Phenols, Naphthalene, Acenaphthylene, Acenaphthene, Fluorene, Phenanthrene, Anthracene, Fluoranthene, Pyrene, Benz(a)anthracene, Benzo(a)pyrene, and Sulfides.





6.4.5 Infrastructure crossing natural drainage lines

Impact assessment

The airstrip and a road lie across the Kamansiniga River and its associated wetland area. This may lead to decreased flows as the water is dammed upstream and could lead to negative impacts in the downstream wetlands, and potentially the lagoon which is a sensitive area that communities use for various rituals.

Impact Classification

In terms of reduced flows to the wetlands this has been recorded as having a medium magnitude where the affected environment is altered, but natural, and/or cultural and social functions and processes continue albeit in a modified way, and valued, important, sensitive or vulnerable systems or communities are moderately affected. If the Luzira is affected then it would be rated as high receptor sensitivity, where natural recovery of the receiving environment is expected in the long-term (>5 years) or cannot be readily predicted due to uncertainty over the nature of the potential impact, and where unique or highly valued ecological, social or cultural resources could be adversely affected.

In this case the overall impact severity is rated as **major**.

Mitigation

Where roads and the airstrip have already been constructed, inspection should be undertaken to assess whether the drainage lines have been impacted in such a manner that is leading to decreased flows and erosion downstream, and if so, an adequately designed culvert will need to be put in place to allow the peak design flood with minimum backwater to pass.

The entrances and exits from the culvert must be protected to prevent erosion and collection of debris, which would block the flow. Should the mitigation be in place, or put in place if necessary, the impact will be reduced to low magnitude receptor sensitivity with an overall **low** impact severity.

6.4.6 Oil leaks along the pipeline

Impact Assessment

The Kingfisher well fluids, consisting of a mixture of crude, gas and water, will be delivered to the CPF via buried flowlines from each of the four well pads. The flowlines will cross minor drainage lines from the escarpment near Pad 2 and south of the airstrip en route to Pad 3. Flowlines will be buried 1 m below ground to top-of-pipe and may be less in constrained locations, however it is noted that this is rarely if ever the case in the study area.

The export pipeline stretches along a 48 km area from the CPF to the Kabaale and crosses the Hohwo and Ngema rivers at about 27 and 35 kilometres respectively. At these crossings the flowlines will be buried beneath the maximum scour depth of the river course as illustrated in Figure 33.

Oil leaks could occur, which would cause contamination of the run-off water into the groundwater and surface water systems at the drainage lines.

The depth of burial is based on the ISO 13623 standard and is intended to minimise the risk of pipeline exposure due to erosion gulleys or accidental excavation. The pipeline will be buried with a surrounding cushion of frictionless material, typically a well-graded sand without rocks or large stones in it, to prevent damage to the pipe coating during the process of pipe-laying or during operation.

Impact Classification

This impact is ranked with a medium magnitude and high receptor sensitivity should a leak occur where the pipeline underlies a river or drainage line and where the resources could be impacted to such an extent that a body of water cannot be used by the communities for a period of time and the ecology is considerably damaged. In this respect there is a rating of an overall **major** impact severity.





Mitigation

The flowlines require little maintenance on a day to day basis, however the right of way will be monitored regularly for any signs of human activity (for example, excavation) that could create a risk, and for any leaks. A major flowline failure would be picked up by a pressure drop in the line, recorded in the control room at the CPF. It is therefore of utmost importance that the control systems are maintained. Minor leaks would typically manifest as a small patch of dying vegetation at the surface or as a sheen of oil at a river crossing or in a downstream water body.

There are several design specifications that must be strictly adhered to including:

- Flowlines will be rated to cater for overpressure conditions;
- Corrosion protection (cathodic protection);
- Lifespan of 25 years.

With mitigation in place the impact would be of a low magnitude, however the receptor would still be of medium sensitivity resulting in an overall **moderate** impact significance.

6.4.7 Rise in water level of Lake Albert

Impact Assessment

During the operational phase and with the expected change in climatic conditions over the next decades (see section 5.2.1), a rise in the water level could lead to an increase in erosion of the shoreline, thereby reducing the width of the Flats. Flooding of the Flats could occur and would have a large impact on infrastructure with potential for pollution, specifically from the pads that are located close to the lake. This could have a potential disastrous impact on the environment and risk to human lives.

Impact Classification

Without mitigation this aspect is scored as a high magnitude where natural and/or cultural or social functions and processes may be altered to the extent that they will temporarily or permanently cease, and valued, important, sensitive or vulnerable systems or communities are substantially affected – this could be specific to the Luzira and are of the lake around the well pads should contamination due to erosion occur. The changes to the natural and/or cultural / social- economic processes and functions could be drastic. The receptor sensitivity is therefore rated as high, with an overall **major** impact severity.

Mitigation

Measures for erosion prevention around the drill pads should be put in place so that should erosion start occurring, timeous action can take place. The protocols that should be applied in the event of a significant raise in water level should be developed and documented in the EMP. A management plan should be prepared and carried out in this event.

Mitigation will result in the impact being ranked with a medium magnitude and low receptor sensitivity, an overall **moderate** impact severity.

6.4.8 Impact on Lake Albert volume due to abstraction for the project

Impact Assessment

A high level water balance for the Lake Albert was determined using an average rainfall over the Lake of 750 mm/annum and is presented in Table 19.





Table 19: Conceptual water balance over Lake Albert

Sources/sinks	Percentage of total	Volume (Million MI/a)
Sources		
Direct rainfall	10	3 975
Semliki and Victoria Nile	83	32 993
Runoff from catchments	7	2 283
Total inflow	39 750	
Sinks		
Evaporation	26	10 335
Abstractions	4	1 590
Albert Nile	70	27 825
Total	39 750	

During the operational phase, the Kingfisher Development Area will require between 520 m³/day and 7 315 m³/day which equates to between 191 260 MI/annum and 2 669 245 MI/annum. This equates to between 0.00048% and 0.00654 % of the average inflow into Lake Albert. This is much less than the monthly variations observed naturally at Lake Albert so will have a negligible impact.

Impact Classification

Based on the negligible impact scenario the rating is ranked as a low magnitude and very low receptor sensitivity, with an overall **negligible** impact severity.

Mitigation

Monitoring of the Lake water level should be put in place, and monitoring of the abstracted volumes recorded daily.

There is currently no trans-boundary agreement between countries legislating the conjunctive management of the Nile River Basin. However, due to the high sensitivity of this trans-boundary resource, part of the Nile River, proactive engagement with the relevant authorities over the course of the operations should take place.

The impact significance should not change.

6.4.9 Discharge of poor quality effluent from the sewage works

Impact assessment

The planned capacity of the domestic sewage treatment plant is 45 m³/day, making provision for an estimated 135 personnel plus contingency. Treated sewage effluent will meet the more stringent of the Ugandan and IFC treated sewage effluent requirements. The sewage treatment plant will be located at the permanent camp. Backup sewage treatment capability will be provided by the sewage treatment plant built to supply the drilling camp, which has spare capacity for an additional 90 people. The two sewage plants will be linked to allow for maintenance shutdowns of either plant. After drilling is completed in year 6, the drilling sewage plant will be maintained as a backup.

Sewage from the CPF will be routed via conservancy tanks to a regulating tank at the permanent camp from where it will be treated in a Membrane Bioreactor sewage treatment works.

Options for final disposal of treated sewage effluent include:

- the base case (discharge into perimeter drains around the CPF, which discharge into small drainage lines leading to Lake Albert);





- irrigation onto land in the buffer area around the CPF and at the personnel camp lawns and gardens; and
- discharge into an artificial wetland.

Should poor quality effluent be discharged to the environment this may have an impact on ecosystems as well as human health.

Impact Classification

The impact is rated with a medium magnitude where the affected environment is altered because of specific impacts related to bacterial contamination, and potentially nutrient enrichment from nitrates and phosphates. The receptor sensitivity is recorded as low as the natural recovery of the impacted area to the baseline or pre-project condition is expected in the very short-term, resulting in a **moderate** impact severity.

Mitigation measures

The design will provide for secondary containment around storage tanks of hazardous liquids, so as to minimize the risk of spillages due to accidents or leaks. Secondary containment shall consist of berms, dykes or walls capable of containing the larger of 110% of the largest tank or 25% of the combined tank volumes in areas with above-ground tanks with a total storage volume equal to or greater than 1 000 litres and will be made of impervious, chemically resistant material.

Treated sewage effluent needs to comply with the values set out in Table 16. It is recommended that the effluent be irrigated on the green areas around the CPF and camps as well as to the environment behind the CPF, rather than discharged directly back into a water resource, or a man-made wetland be constructed upstream of the discharge to act as a buffer.

The disposal and storage of sludge from the sewage works will need to be handled in a manner that will render the sludge stable and safe to use as a soil ameliorant or collected and disposed of at an accredited waste site: disposed of in accordance with the local regulatory requirements. If there are no local requirements, the disposal methods should be in keeping with the protection of public health and safety and conservation of the environment and the natural water and land resources.

If the recommended construction protocols are followed and the final effluent discharged as recommended and sludge is disposed of safely, then impacts during the operational phase will be reduced to low magnitude and sensitivity, resulting in an overall **minor** impact severity.

7.0 RECOMMENDED MITIGATION MEASURES

7.1 Construction

Mitigation measures proposed for the construction phase are presented in Table 20.

Table 20: Surface Water Impacts during Construction Phase

Mitigation Measures	Monitoring Indicators	Monitoring Frequency	Responsible Entity	Training Necessary
Prevention of obstruction of water flow: Impediments to natural water flow shall be avoided, or, if unavoidable, be allowed for in the design by means of appropriately sized and positioned drains and culverts.	No damming of water or obstructions to water flow (natural or during storm events).	At all times	CNOOC Contractor All contractors	None.
Prevention of surface water pollution by chemicals management: Appropriate designs and measure in place to collect and	Water quality analysis water bodies in the receiving environment.	Monthly	CNOOC Contractor All contractors	None.





SURFACE WATER SPECIALIST REPORT

Mitigation Measures	Monitoring Indicators	Monitoring Frequency	Responsible Entity	Training Necessary
manage spills and prevent contamination of surface water.				
<p>Storm water management: Potentially contaminated storm water shall be kept separate from other drainage at camp sites. Potentially contaminated storm water shall, if necessary, be tested and treated to remove contaminants before being released into the environment.</p>	<p>Identification of areas where activities could cause contamination and evidence of measures taken to avoid these.</p> <p>Runoff water quality (records).</p> <p>Links to surface water monitoring</p>	As required before discharge is to be considered	CNOOC Contractor All contractors	None.
<p>Flood management: To avoid obstruction to storm water flows, culverts, drains and other means shall be used as necessary.</p>	Details of measures implemented in designs.	Prior to commencement of construction activities.	CNOOC Contractor All contractors	None.
<p>Dust Suppression: Biodegradable chemical suppression or the use of water sprayers is required to keep the dust levels low and avoid sedimentation in the local surface waters.</p>	Sedimentation of the water courses	At all times.	CNOOC Contractor All contractors	None
<p>Sewage water management: Any discharge from sewage works should meet the IFC Environmental, Health and Safety (EHS) Guidelines for treated sanitary sewage discharge quality.</p>	Water quality analysis on treated water	Monthly	CNOOC Contractor All contractors	None
<p>Storm water Management: Any storm water that has been contaminated by oil, grease or other chemicals from site activity needs to be treated to the discharge standards</p>	Spill volumes	Continuously	CNOOC Contractor All contractors	None
<p>Process Water Management: Management of process water to prevent spillages into the environment</p>	Spill volumes	Continuously	CNOOC Contractor All contractors	None

7.1.1.1 Sewage management

Any discharge from sewage works should meet the IFC Environmental, Health and Safety (EHS) Guidelines for treated sanitary sewage discharge quality as presented in Table 21.





Table 21: Indicative Values for Treated Sanitary Sewage Discharges (International Finance Corporation, 2007)

Pollutants	Units	Guideline Value
pH	pH	6 to 9
BOD	mg/l	30
COD	mg/l	125
Total Nitrogen	mg/l	10
Total Phosphorus	mg/l	2
Oil and Grease	mg/l	10
Total Suspended Solids	mg/l	50
Total Coliform Bacteria	MPN*/100 ml	400

* Most Probable Number

7.1.1.2 Storm water management

The IFC guidelines specify that a storm water management plan needs to be in place from the construction phase right through to the operational phase in order to reduce the impact on the natural surface water. Any storm water that has been contaminated by oil, grease or other chemicals from site activity needs to be treated to the discharge standards listed in Table 22 before it can be released to the environment (International Finance Corporation, 2007). The key principles need to be applied during construction in order to manage surface runoff resulting from precipitation or drainage (International Finance Corporation, 2007):

- Plan construction activities to avoid sensitive times of the year, like heavy rain seasons.
- Minimize areas to be cleared, and use hand cutting tools where possible to avoid unnecessary increases in erosion in the area and sedimentation in the surface waters.
- Avoid construction of facilities in a floodplain and within a distance of 100 m of the normal high-water mark of bodies of water used for drinking and domestic purposes.
- Consider the use of existing roads for access in order to reduce the impact of erosion, sedimentation and obstruction to the natural surface water flow. Try to construct pipelines along existing infrastructure and roads.
- Install temporary erosion, sediment control measures and slope stabilization measures at all times where necessary.
- The peak discharge rate should be reduced in areas of development in order to reduce the potential erosion of the flow paths and sedimentation of downstream surface waters.
- Storm water should be kept separate from other process and sanitation wastewater streams to reduce the volume of wastewater to be treated.
- Runoff from process areas should be kept separate from less contaminated (or sediment heavy) runoff areas so as to not further contaminate more water. Storm water from process areas needs to be treated to the discharge standards listed in Table 22 before being released to the environment.
- Oil/water separators and grease traps should be installed and maintained at refuelling areas, workshops, parking areas and fuel storage areas.
- Runoff from areas with potential sources of contamination and sediment loading should be minimized where possible.



- Reuse of storm water and contaminated runoff should be done as much as possible. Storm water should be managed as a resource.

Table 22: Emissions, Effluent and Waste Levels from Onshore Oil and Gas Development (International Finance Corporation, 2007)

Parameter	Guideline Value
Produced Water and Hydrotest Water	For Discharge to surface waters or to land: Total hydrocarbon content 10 mg/l pH: 6 to 9 BOD: 25 mg/l COD: 125 mg/l TSS: 35 mg/l Phenols: 0.5 mg/l Sulfides: 1 mg/l Heavy metals* (total): 5 mg/l Chlorides: 600 mg/l average; 1 200 mg/l maximum
Completion and Well work-over fluids	For discharge to surface waters or to land: Total hydrocarbon content 10 mg/l pH: 6 to 9
Storm water Drainage	Storm water runoff should be treated through an oil/ water separation system able to achieve oil and grease concentration of 10 mg/l
Cooling Water	The effluent should result in a temperature increase of no more than 3°C at the edge of the zone where initial mixing and dilution take place. Where the zone is not defined, use 100 m from point of discharge.

7.1.1.3 Process water management

In the construction phase, the only process water should be that of hydrostatic testing which is done on the pipelines to detect leaks and verify the integrity of the pipeline and the equipment. There are often chemical additives in the hydrostatic testing water like corrosion inhibitors, oxygen scavengers and dyes. Due to these chemical additives, it is important that this water does not adversely affect the natural surface water in the area. The following principles should be considered when dealing with hydrostatic testing water:

- Test manifolds installed into sections of newly constructed pipeline should be located outside of riparian zones and wetlands;
- The source of water used for hydrostatic testing purposes should not negatively impact the water levels or flow rates of the natural water body, and the volume (or rate) of withdrawal should not exceed 10% of the stream volume (or flow);
- Erosion control measures and fish screens should be in place when withdrawal from the water source is carried out;
- Disposal alternatives for the hydrostatic testing water include injection into disposal well or discharge to surface water or land;
- If disposal to the surface water or land is chosen, the use of chemicals should be minimized by reducing the time that the water spends in the pipeline. The chemicals used should be selected carefully so as to reduce the concentration of the additive, reduce the toxicity and increase the biodegradability and bioavailability;





- Reuse of the hydrostatic testing water should be done as far as possible;
- When discharging this water, the quality needs to be within the IFC EHS guidelines as set out in Table 22; and
- Break tanks or energy dissipaters and sediment controls should be used when discharging the water to the environment to avoid erosion and sedimentation in the downstream water bodies. If discharged to water, the discharge point should be selected carefully so that the quality of discharge does not negatively impact the water body. If discharge is onto the land, then the discharge site should avoid cultivated land, sensitive land or sites that might be prone to flooding or erosion.

7.2 Operational phase

Mitigation measures proposed for the operational phase are presented in Table 23.

Table 23: Surface Water Impacts during Operation Phase

Mitigation Measures	Monitoring Indicators	Monitoring Frequency	Responsible Entity	Training Necessary
Prevention of obstruction of water flow: Impediments to natural water flow shall be avoided, or, if unavoidable, be allowed for in the design by means of appropriately sized and positioned drains, culverts etc.	No damming of water or obstructions to water flow.	At all times.	CNOOC Base camp management contractor	None.
Stormwater management*: Potentially contaminated stormwater shall be kept separate from other drainage at Base camp and other drilling activity sites. Potentially contaminated stormwater shall, if necessary, be tested and treated to remove contaminants before being released into the environment.	Water quality monitoring records. Identification of areas where activities could cause contamination and evidence of measures taken to avoid these.	At all times.	CNOOC Base camp management contractor	None.
Flood management: <ul style="list-style-type: none"> ■ The location of areas prone to flooding relative to the well sites, campsites and access roads shall be confirmed and any consequences of this for drilling programme shall be determined and minimised as soon as possible. ■ Every effort shall be made to ensure the maintenance of the natural flow of water following storm events. ■ No works shall increase the risk of erosion during storm events. Should this be unavoidable specific erosion control measures shall be implemented for the duration that the risk exists. 	No alterations to natural flows. Details of measures implemented to prevent erosion.	At all times	CNOOC Base camp management contractor drilling sub-contractors	None.





Sewage management: Any discharge from sewage works should meet the IFC Environmental, Health and Safety (EHS) Guidelines for treated sanitary sewage discharge quality.	Water quality analysis on treated water	Monthly	CNOOC Contractor All contractors	None
--	---	---------	---	------

*The operational storm water management plan will be discussed in further detail.

7.2.1.1 Sewage water management

The IFC General EHS guidelines for environmental wastewater and ambient water quality set out recommended sanitary wastewater management strategies. These include (International Finance Corporation, 2007):

- Keeping the waste produced by food services, laundry, laboratories, medical infirmaries and sewage waste separate in order to ensure that the treatment for each is specific and efficient;
- If treated sewage is to be released to the environment then the discharged effluent needs to meet the local or national standards for sanitary wastewater. If there are no standards in place, the guidelines set out in the IFC EHS general guidelines should be used (Table 21).
- The sludge from sanitary wastewater treatment systems should be disposed of in accordance with the local regulatory requirements. If there are no local requirements, the disposal methods should be in keeping with the protection of public health and safety and conservation of the environment and the natural water and land resources.

7.2.1.2 Storm water management plan

The proposed infrastructure on the Kingfisher Development Area will be built on a higher elevation in order to avoid flooding in the Buhuka Flats. The clean water runoff that would report to the infrastructure will be diverted around the elevated edge of the infrastructure. It is assumed that the infrastructure will be raised high enough to prevent the 1 in 100 year ARI flood from infiltrating the elevated working area. In light of this design, no diversion berms or channels are required to divert the clean water away from contaminated areas. The dirty water within the working areas needs to be contained and channelled to settling tanks, treatment and oil and grease separation tanks before the water is released to the environment due to the sensitivity of the Lake Albert water resource. The following recommendations are made in order to comply with the IFC EHS Oil and gas development guidelines (International Finance Corporation, 2007):

- The storm water should be kept separate from process and sanitary wastewater streams so that the volume of water to be treated to a higher degree is reduced;
- All process areas should be bunded to ensure storm water flows into the closed drainage system and that uncontrolled surface runoff is avoided;
- If there is a point where clean runoff might enter into a site work area, a system of diversion conduits should be used to prevent clean surface water runoff from the catchments upstream side entering the work area according to international requirements. The diverted clean runoff should be diverted to the local drainage channels;
- Drip trays and other control measures should be used to collect runoff from areas that are not contained within the bunded drainage areas. These collection points should be directed to the closed drainage system;
- Monitoring of storm water and impoundments should begin as soon as possible once drilling commences;
- When final infrastructure plans become available, a more accurate delineation of clean and dirty areas should be compiled;





- Sediment settlement basins and erosion control structures should be constructed down slope of all spoils stock pile areas, the crusher plant and bitumen storage area and areas of exposed terrain in order to manage the increase in sedimentation in the natural water bodies;
- Local runoff is collected and treated to remove sediments to acceptable levels prior to release to the natural environment. Bunds and drainage diversion works should be constructed around the perimeter of all infrastructure areas, designed to divert and prevent natural runoff waters originating outside the development sites from mixing with internal site runoff;
- Sediment settlement basins should generally be located at low points, by forming earth bunds. Storage volume consists of a permanent pool settling zone and sediment storage zone. The trap size is calculated to match the settling velocity of the target sediment size with the design flow. A target of medium sized silt particles of >0.02 mm (20 µm) is generally adopted. Hence the sediment basin is expected to be effective in removing sand and medium to coarse silt, and less effective in removal of fine silt and clay for the design event;
- After a storm event, the water in the basin slowly infiltrates/evaporates or is pumped out for recycling. Prior to the commencement of the wet season, the sediment basins are cleaned out. A ramp into the basin is included so that sediment removal may be undertaken by front end loader (or similar). The removed sediments should be contained in an area where they cannot be transported in the next storm event back into the sediment trap, or to the downstream environment;
- Where possible the storm water should be reused in the oil and gas works operations and treated as a resource;
- Oil separators and grease traps should be installed and maintained at refuelling stations, workshops, in parking areas, at fuel storage areas and containment areas. The oil/water separation process should be able to achieve an oil grease concentration of 10 mg/l as noted in Table 22;
- Sludge and sedimentation that build up in the storm water drainage system may contain contaminants and should be disposed of according to local regulation. If there are no regulations, then disposal should be consistent with protection of public health and safety and the conservation of water and land resources;
- Potential chemical and/ or oil and grease contamination could occur at the following areas of infrastructure: the CPF, the material yard (for drilling and production), and the well pads. Due to the potential contamination of surface runoff water in these areas, it is recommended that appropriate local treatment and/or oil and grease traps are installed and maintained downstream of the collection channels around these sites. The areas and total runoff volume that can be expected for the 1 in 2, 10, 30, 50 and 100 year 24 hour ARI storm events is presented in Table 24;
- These runoff volumes were calculated based on the peak rainfall events. The dirty catchment areas were based on the layout of the proposed site provided to Golder Associates and would need to be updated when more accurate layout dimensions are determined. The areas were assumed to be 90% impermeable, with a CN number of 98. The overland flow on these surfaces was assumed to have a Mannings n value of 0.012 for the impermeable surfaces, and 0.13 for the permeable surfaces.

Table 24: Total Runoff Volumes Expected in Potentially Contaminated Areas for the 1 in 2, 10, 20, 50 and 100 year 24 hour Storm Events

Infrastructure	Catchment area (ha)	Return Period				
		1 in 2	1 in 10	1 in 20	1 in 50	1 in 100
		Volume of water (m ³)				
Pad 1	2.1675	1230	1800	2020	2300	2510
Pad 2	4.2101	2400	3490	3920	4460	4880
Pad 3	0.7777	440	650	720	820	900





Infrastructure	Catchment area (ha)	Return Period				
		1 in 2	1 in 10	1 in 20	1 in 50	1 in 100
		Volume of water (m ³)				
Pad 4-2	0.2173	120	180	200	230	250
Pad 5	0.4665	270	390	430	490	540
Material Yard (for drilling only)	3.6748	2090	3050	3420	3900	4260
Material Yard (For production only)	5.457	3110	4530	5070	5780	6330
CPF	28.0787	16000	23310	26120	29770	32580

7.2.1.3 Process water management

Process water contains a complex mixture of inorganic and organic compounds including dissolved salts, trace metals, suspended particles, hydrocarbons and organic acids. Process water may also contain chemical additives such as scale and corrosion inhibitors. Because of this, the disposal of process water needs to be carefully planned in order to prevent negative impacts on the surface water. The disposal method set out for the Kingfisher Development Area is the injection of the process water into the reservoir to enhance oil recovery. It should be noted that other possible uses of the process water could be in irrigation or dust control if the quality of the water is suitable for these activities.

The IFC EHS guidelines on Onshore Oil and Gas Development state that the process water needs to meet the quality limits presented in Table 22 before the water can be discharged to the environment. Other recommendations set out by these guidelines include (International Finance Corporation, 2007):

- The reduction of the volume of process water for disposal by:
 - Good well-management during well completion activities to minimize water production;
 - Recompletion of high water producing wells;
 - The use of downhole fluid separation techniques and water shutoff techniques where possible; and
 - Shutting in high water producing wells.
- The selection of additive chemicals should be done carefully, taking into account the toxicity, volume and bioavailability of the additive.
- If cooling or heating systems are required, the discharge from these systems should ensure that the water released to the environment is within 3°C of ambient water temperatures at the edge of the defined mixing zone or within 100 m of the discharge point.





8.0 REFERENCES

- WSS Services (U) Ltd. (2012). *Assessment of water use and demand in Lake Albert Basin of Uganda*. Kampala: Republic of Uganda - Ministry of water and environment.
- Computational Hydraulics International. (1984). PCSWMM 2012. Version 5.2.1319 Professional 2D. Ontario: Computational Hydraulics International.
- Fiddes D., F. J. (1974). *TRRL Laboratory Report 623: The Prediction of Storm Rainfall in East Africa*. Crowthorne, Berkshire: Department of the Environment, Transport and Road Research Laboratory.
- Global Climate Change Alliance. (2012). *Adaption for climate change in Uganda*. Retrieved June 2014, from Global Climate Change Alliance: <http://www.gcca.eu/national-programmes/africa/gcca-uganda>
- International Finance Corporation. (2007, April). *General EHS Guidelines: Environmental Wastewater and ambient Water Quality*. Retrieved 06 11, 2014, from Environmental, Health, and Safety (EHS) Guidelines:
http://www.ifc.org/wps/wcm/connect/Topics_Ext_Content/IFC_External_Corporate_Site/ifc+sustainability/sustainability+framework/Sustainability+Framework+-+2006/Environmental,+Health,+and+Safety+Guidelines/ehsguidelines
- International Finance Corporation. (2007, April 30). *Onshore Oil and Gas development*. Retrieved 06 11, 2014, from Environmental, Health, and Safety (EHS) Guidelines:
http://www.ifc.org/wps/wcm/connect/Topics_Ext_Content/IFC_External_Corporate_Site/IFC+Sustainability/Sustainability+Framework/Environmental,+Health,+and+Safety+Guidelines/
- International Finance Corporation. (2012). *IFC Performance Standards on Environmental and Social Sustainability*. IFC.
- International Lake Environmental Committee. (n.d.). *Lake Albert*. Retrieved from World Lake database: http://wldb.ilec.or.jp/data/databook_html/afr/afr-11.html
- International Lake Environment Committee Foundation. (1999). *World Lake Database*. Retrieved 06 03, 2014, from Lake Albert: http://wldb.ilec.or.jp/data/databook_html/afr/afr-11.html
- KNMI. (2013). Retrieved 12 11, 2013, from KNMI Climate Explorer:
<http://climexp.knmi.nl/start.cgi?id=someone@somewhere>
- Munson, B., Young, D., Okiishi, T., & Huebsch, W. (2009). *Fundamentals of fluid mechanics, 6th ed*. Wiley & Sons.
- NEMA. (1996). *State of the environment Report for Uganda*. Kampala: National Environmental Management Authority.
- Ramsar. (1992). *Ramsar Wetlands - Uganda*. Retrieved June 2014, from <http://ramsar.wetlands.org/Portals/15/UGANDA.pdf>
- Savimaxx Limited. (2006). *Lake Albert Eastern Catchment Management Initiative, Uganda: Baseline study on water quality monitoring programme, August/September 2005*. World Wide Fund for Nature and EARPO.
- The World Bank Group. (2017, September). *Climate Change Knowledge Portal 2.0*. Retrieved 2014, from <http://sdwebx.worldbank.org/climateportal/index.cfm>
- Uganda National Environmental Management Authority. (2010). *Environmental sensitivity atlas for the Albertine Graben - 2nd edition*. Kampala.
- UNDP and WMO. (1974). *Hydro meteorological Survey of Catchments of Lakes Victorie, Kyoga and Albert*. Geneva: World Meteorological Organization.





USACE. (2010). HEC-RAS River Analysis System's User's Manual. Version 4.1. California: USACE: US Army Corps of Engineers.

WHO. (2011). *World Health Organisation Guidelines for Drinking-Water Quality*. Geneva: WHO Press.





GOLDER ASSOCIATES AFRICA (PTY) LTD.

Author: Lee Boyd
Water Resource Scientist
MSc Water Utilization, BScHons, BSc
Senior review: Trevor Coleman
Principal, Water Resource Engineer
MSc.Eng, BSc.Civ.Eng.

Senior review: Trevor Coleman
Principal, Water Resource Engineer
MSc.Eng, BSc.Civ.Eng.





APPENDIX A

Constants used in the Rational method for the calculation of flood lines



Lower Catchments

Percentage Coverage of Surface Slopes

Surface slope	Percentage Coverage
Vleis and pans	51%
Flat areas	19%
Hilly	27%
Steep areas	3%

Permeability of Land Surface

Permeability	Percentage Coverage
Very permeable	45%
Permeable	45%
Semi-permeable	50%
Impermeable	5%

Percentage Coverage of Different Vegetation Types

Vegetation	Percentage Coverage
Thick bush and plantation	0%
Light bush and farm-lands	3%
Grass lands	90%
No vegetation	7%

Pipeline Catchments

Percentage Coverage of Surface Slopes

Surface slope	Percentage Coverage
Vleis and pans	21%
Flat areas	25%



Surface slope	Percentage Coverage
Hilly	50%
Steep areas	4%

Permeability of Land Surface

Permeability	Percentage Coverage
Very permeable	45%
Permeable	50%
Semi-permeable	5%
Impermeable	1%

Percentage Coverage of Different Vegetation Types

Vegetation	Percentage Coverage
Thick bush and plantation	5%
Light bush and farm-lands	55%
Grass lands	30%
No vegetation	10%



APPENDIX B

Results obtained from initial water quality sampling run





NATIONAL WATER QUALITY REFERENCE LABORATORY - ENTEBBE

CERTIFICATE OF ANALYSIS

Name of client : Golder Associates
 Date of sampling : 23rd Dec 2013
 Serial no : LIMNO/2014/03

Sampled by: Eco & Partner
 Date received : 23rd Dec 2013
 Date of reporting: 3 March 2014

Source name	CNOOC SW 12		CNOOC GW 1		CNOOC GW 2		Acceptable Standard NEMA, 1995
Source location/GPS	Eastings	Northings	Eastings	Northings	Eastings	Northings	
Parameters	Units/Lab No		E22167		E22169		
Cadmium (Cd)	mg/L	<0.0005	<0.0005	0.0561	<0.0005	<0.0005	0.01
Chromium (Cr)	mg/L	0.0006	0.0004	0.0633	0.0008	0.0008	0.05
Lead (Pb)	mg/L	0.0044	<0.0004	0.0693	0.0059	0.0059	0.01
Mercury (Hg)	mg/L	0.001	<0.001	0.0032	0.001	0.001	0.001
Iron (Fe)	mg/L	<0.002	1.5887	0.3983	<0.002	<0.002	0.03-3.5
Aluminium (Al)	mg/L	<0.006	<0.006	0.527	<0.006	<0.006	0.2
Arsenic (As)	mg/L	<0.003	<0.003	<0.003	<0.003	<0.003	0.01
Copper (Cu)	mg/L	<0.0004	<0.0004	0.0581	0.0024	0.0024	1
Manganese (Mn)	mg/L	0.0013	0.5524	0.0628	0.0046	0.0046	0.1-0.5
Zinc (Zn)	mg/L	<0.001	<0.001	0.0815	<0.001	<0.001	3
Cobalt (Co)	mg/L	0.0018	0.0015	0.0607	<0.001	<0.001	NS
Nickel (Ni)	mg/L	<0.005	<0.005	0.0615	<0.005	<0.005	0.02
Selenium (Se)	mg/L	0.0274	0.0085	0.0707	0.0416	0.0416	0.01

NOTE:

- The type of sample container and sample holding time affect the integrity of the sample and hence the results of analysis
- Values lower than the detection limit reported as <DL
- DL stands for Defection Limit

Checked: *[Signature]*
 Laboratory Manager
 Date: *07/03/2014*

**PRINCIPAL ANALYST
LABORATORIES**

Issued *[Signature]*
 Principal Analyst
 Date: *07/03/2014*

NATIONAL WATER QUALITY
 REFERENCE LABORATORY - ENTEBBE
 Sign: *[Signature]*

Directorate of Water Resources Management Department
 P.O Box 19, Entebbe
 Tel: 041-321342
 Fax: 041-321368



NATIONAL WATER QUALITY REFERENCE LABORATORY - ENTEBBE

CERTIFICATE OF ANALYSIS

Name of client : Golder Associates
 Date of sampling : 23rd Dec 2013
 Serial no : LIMNO/2014/03

Sampled by: Eco & Partner
 Date received : 23rd Dec 2013
 Date of reporting: 3 March 2014

Source name	CNOOC SW1	CNOOC SW 2	CNOOC SW 4	CNOOC SW 6	CNOOC SW 9	Acceptable Standard
Source location/GPS	Eastings N01°15'53.6" Northings E30°45'27.5"	N01°15'50.6" E30°45'35.7"	N01°15'16.4" E30°45'33.0"	N01°14'24.9" E30°45'26.1"	N01°13'40.9" E30°45'10.0"	NEMA, 1995
Parameters	Units/Lab No	E22162	E22163	E22164	E22165	
Cadmium (Cd)	mg/L	<0.0005	<0.0005	<0.0005	<0.0005	0.01
Chromium (Cr)	mg/L	0.0002	0.0004	0.0006	0.0004	0.05
Lead (Pb)	mg/L	0.0042	<0.0004	<0.0004	<0.0004	0.01
Mercury (Hg)	mg/L	0.001	<0.001	<0.001	<0.001	0.001
Iron (Fe)	mg/L	<0.002	<0.002	<0.002	<0.002	0.03-3.5
Aluminium (Al)	mg/L	0.201	<0.006	<0.006	<0.006	0.2
Arsenic (As)	mg/L	<0.003	<0.003	<0.003	<0.003	0.01
Copper (Cu)	mg/L	<0.0004	<0.0004	<0.0004	<0.0004	1
Manganese (Mn)	mg/L	0.001	0.0015	0.0004	0.0011	0.1-0.5
Zinc (Zn)	mg/L	<0.001	<0.001	<0.001	<0.001	3
Cobalt (Co)	mg/L	<0.001	<0.001	0.001	<0.001	NS
Nickel (Ni)	mg/L	<0.005	<0.005	<0.005	<0.005	0.02
Selenium (Se)	mg/L	0.0309	0.0217	0.0181	0.008	0.01

NOTE:

- The type of sample container and sample holding time affect the integrity of the sample and hence the results of analysis
- Values lower than the detection limit reported as <DL
- DL stands for Detection Limit

Checked: *[Signature]*
 Laboratory Manager
 Date: 07/03/2014

Issued **MAR 2014**
 Principal Analyst
 NATIONAL WATER QUALITY REFERENCE LABORATORY - ENTEBBE
 Sign: *[Signature]*

Directorate of Water Resources Management Department
 P.O Box 19, Entebbe
 Tel: 041-321342
 Fax: 041-321368



NATIONAL WATER QUALITY REFERENCE LABORATORY - ENTEBBE

CERTIFICATE OF ANALYSIS

Name of client : Golder Associates
 Date of sampling : 23rd Dec 2013
 Serial no : LIMNO/2014/03

Sampled by: Eco & Partner
 Date received: 23rd Dec 2013
 Date of reporting: 3 March 2014

Source name	Eastings	Northings	Kachunde stream	Ususa BH (shallow well)	L. Albert	Senjojo stream	Nsonga shorelines	Acceptable Standard
Source location/GPS								NEMA, 1995
Parameters	Units/Lab No							
Cadmium (Cd)	mg/L		<0.0005	<0.0005	<0.0005	<0.0005	<0.0005	0.01
Chromium (Cr)	mg/L		0.0004	0.0007	0.0004	<0.0002	0.0003	0.05
Lead (Pb)	mg/L		<0.0004	<0.0004	0.0025	<0.0004	0.0025	0.01
Mercury (Hg)	mg/L		<0.001	<0.001	0.001	<0.001	0.0011	0.001
Iron (Fe)	mg/L		<0.002	<0.002	<0.002	<0.002	<0.002	0.03-3.5
Aluminium (Al)	mg/L		0.168	<0.006	0.193	<0.006	0.034	0.2
Arsenic (As)	mg/L		<0.003	<0.003	<0.003	<0.003	<0.003	0.01
Copper (Cu)	mg/L		<0.0004	<0.0004	<0.0004	<0.0004	<0.0004	1
Manganese (Mn)	mg/L		0.0007	0.1633	0.0008	<0.0004	0.0007	0.1-0.5
Zinc (Zn)	mg/L		<0.001	<0.001	<0.001	<0.001	<0.001	3
Cobalt (Co)	mg/L		0.001	<0.001	0.001	<0.001	0.001	NS
Nickel (Ni)	mg/L		<0.005	<0.005	<0.005	<0.005	<0.005	0.02
Selenium (Se)	mg/L		0.0134	0.0027	0.0244	0.011	0.0141	0.01

NOTE:

- The type of sample container and sample holding time affect the integrity of the sample and hence the results of analysis
- Values lower than the detection limit reported as <DL
- DL stands for Detection Limit

Checked: 
 Laboratory Manager
 Date: 27/03/2014



Directorate of Water Resources Management Department
 P.O Box 19, Entebbe
 Tel: 041-321342
 Fax: 041-321368



NATIONAL WATER QUALITY REFERENCE LABORATORY - ENTEBBE

CERTIFICATE OF ANALYSIS

Name of client : Golder Associates
 Date of sampling : 23rd Dec 2013
 Serial no : LIMNO/2014/03

Sampled by: Eco & Partner
 Date received: 23rd Dec 2013
 Date of reporting: 3 March 2014

Source name	Kyabasambu stream		Kyenyanja BH	Busigi BH	Busigi stream	Ususa spring	Kina BH	Kina shores	Acceptable Standard NEMA, 1995
	Eastings	Northings							
Source location/GPS	250301	137495	253969	252471	252682	257901	246306	246408	
Parameters									
	Units/Lab No	E22157	E22160	E22158	E22159	E22155	E22152	E22151	
Cadmium (Cd)	mg/L	<0.0005	<0.0005	<0.0005	<0.0005	<0.0005	<0.0005	<0.0005	0.01
Chromium (Cr)	mg/L	<0.0002	0.0003	0.001	0.0002	0.0006	<0.0002	0.0002	0.05
Lead (Pb)	mg/L	<0.0004	<0.0004	<0.0004	0.0006	<0.0004	<0.0004	0.0004	0.01
Mercury (Hg)	mg/L	0.001	0.001	<0.001	0.0011	<0.001	<0.001	0.0012	0.001
Iron (Fe)	mg/L	<0.002	<0.002	<0.002	<0.002	<0.002	0.0303	<0.002	0.03-3.5
Aluminium (Al)	mg/L	<0.006	<0.006	<0.006	<0.006	<0.006	<0.006	<0.006	0.2
Arsenic (As)	mg/L	<0.003	<0.003	<0.003	<0.003	<0.003	<0.003	<0.003	0.01
Copper (Cu)	mg/L	<0.0004	0.0009	<0.0004	<0.0004	<0.0004	<0.0004	<0.0004	1
Manganese (Mn)	mg/L	0.0016	0.001	0.0068	0.0013	0.0005	0.1189	0.0004	0.1-0.5
Zinc (Zn)	mg/L	<0.001	<0.001	<0.001	<0.001	<0.001	0.2079	<0.001	3
Cobalt (Co)	mg/L	<0.001	<0.001	<0.001	<0.001	<0.001	0.0011	0.001	NS
Nickel (Ni)	mg/L	<0.005	<0.005	<0.005	<0.005	<0.005	<0.005	<0.005	0.02
Selenium (Se)	mg/L	0.01	0.0133	0.016	0.0158	0.0131	<0.001	0.0121	0.01

NOTE:

1. The type of sample container and sample holding time affect the integrity of the sample and hence the results of analysis
2. Values lower than the detection limit reported as <DL
3. DL stands for Detection Limit

Checked: 
 Laboratory Manager
 Date: 

PRINCIPAL ANALYST LABORATORIES
 Issued: 
 Principal Analyst
 Date: 07 MAR 2014
 NATIONAL WATER QUALITY REFERENCE LABORATORY - ENTEBBE
 Sign: 

Directorate of Water Resources Management Department
 P.O Box 19, Entebbe
 Tel: 041-321342
 Fax: 041-321368



APPENDIX C

Results obtained from second water quality sampling run





Jones Environmental Laboratory

Registered Address : Unit 3 Deeside Point, Zone 3, Deeside Industrial Park, Deeside, CH5 2UA. UK

Unit 3 Deeside Point
Zone 3
Deeside Industrial Park
Deeside
CH5 2UA

Golder Associates Africa Ltd
12 Steven Street
Universitas
Bloemfontein
Free State
9301
South Africa

Tel: +44 (0) 1244 833780

Fax: +44 (0) 1244 833781



Attention : Jennifer Pretorius
Date : 3rd April, 2014
Your reference : CN00C 12614848
Our reference : Test Report 14/4273 Batch 1
Location : Kingfisher
Date samples received : 27th March, 2014
Status : Final report
Issue : 1

Ten samples were received for analysis on 27th March, 2014. Please find attached our Test Report which should be read with notes at the end of the report and should include all sections if reproduced. Interpretations and opinions are outside the scope of any accreditation, and all results relate only to samples supplied.

All analysis is carried out on as received samples and reported on a dry weight basis unless stated otherwise. Results are not surrogate corrected.

Compiled By:

Paul Lee-Boden BSc
Project Manager

Bob Millward BSc FRSC
Principal Chemist

Client Name: Golder Associates Africa Ltd
Reference: CN00C 12614848
Location: Kingfisher
Contact: Jennifer Pretorius
JE Job No.: 14/4273

Report : Liquid

Liquids/products: V=40ml vial, G=glass bottle, P=plastic bottle
 H=H₂SO₄, Z=ZnAc, N=NaOH, HN=HNO₃

J E Sample No.	1-5	6-10	11-15	16-20	21-25	26-30	31-35	36-40	41-45	46-50	Please see attached notes for all abbreviations and acronyms		
Sample ID	SW02	SW03	SW09	SW14	SW15	SW17	SW19	SW20	SW21	SW22			
Depth													
COC No / misc													
Containers	H HN P G	H HN P G	H HN P G	H HN P G	H HN P G	H HN P G	H HN P G	H HN P G	H HN P G	H HN P G			
Sample Date	20/03/2014	20/03/2014	21/03/2014	23/03/2014	23/03/2014	23/03/2014	22/03/2014	23/03/2014	24/03/2014	24/03/2014			
Sample Type	Surface Water	Surface Water	Surface Water	Surface Water	Surface Water	Surface Water	Surface Water	Surface Water	Surface Water	Surface Water			
Batch Number	1	1	1	1	1	1	1	1	1	1			
Date of Receipt	27/03/2014	27/03/2014	27/03/2014	27/03/2014	27/03/2014	27/03/2014	27/03/2014	27/03/2014	27/03/2014	27/03/2014	LOD/LOR	Units	Method No.
Dissolved Aluminium #	<20	<20	<20	<20	<20	<20	<20	<20	<20	<20	<20	ug/l	TM30/PM14
Dissolved Arsenic #	<2.5	<2.5	<2.5	<2.5	<2.5	<2.5	<2.5	<2.5	<2.5	<2.5	<2.5	ug/l	TM30/PM14
Dissolved Barium #	46	49	65	101	50	42	42	93	79	51	<3	ug/l	TM30/PM14
Dissolved Beryllium	<0.5	<0.5	<0.5	<0.5	<0.5	<0.5	<0.5	<0.5	<0.5	<0.5	<0.5	ug/l	TM30/PM14
Dissolved Boron	<12	<12	<12	<12	<12	<12	<12	42	<12	16	<12	ug/l	TM30/PM14
Dissolved Cadmium #	<0.5	<0.5	<0.5	<0.5	<0.5	<0.5	<0.5	<0.5	<0.5	<0.5	<0.5	ug/l	TM30/PM14
Dissolved Calcium #	44.5	37.0	20.5	27.7	20.8	29.7	33.6	11.4	22.9	27.9	<0.2	mg/l	TM30/PM14
Total Dissolved Chromium #	<1.5	<1.5	<1.5	<1.5	<1.5	<1.5	6.3	<1.5	<1.5	<1.5	<1.5	ug/l	TM30/PM14
Dissolved Copper #	<7	<7	<7	<7	<7	<7	<7	<7	<7	<7	<7	ug/l	TM30/PM14
Total Dissolved Iron #	<20	<20	94	4280	52	<20	<20	<20	111	121	<20	ug/l	TM30/PM14
Dissolved Lead #	6	7	7	6	5	<5	5	<5	6	5	<5	ug/l	TM30/PM14
Dissolved Magnesium #	31.1	20.3	11.6	15.2	14.6	18.7	21.5	26.1	13.0	12.5	<0.1	mg/l	TM30/PM14
Dissolved Manganese #	5	4	10	849	7	3	<2	<2	26	183	<2	ug/l	TM30/PM14
Dissolved Mercury #	<1	<1	<1	<1	<1	<1	<1	<1	<1	<1	<1	ug/l	TM30/PM14
Dissolved Nickel #	<2	<2	<2	<2	<2	<2	<2	<2	<2	<2	<2	ug/l	TM30/PM14
Dissolved Potassium #	5.2	2.9	2.0	3.9	1.7	3.2	2.5	40.4	7.6	8.0	<0.1	mg/l	TM30/PM14
Dissolved Selenium #	<3	<3	<3	<3	<3	<3	<3	<3	<3	<3	<3	ug/l	TM30/PM14
Dissolved Sodium #	108.1	77.1	17.1	25.4	26.5	36.7	50.5	64.5	16.3	11.3	<0.1	mg/l	TM30/PM14
Dissolved Vanadium #	3.7	5.2	<1.5	<1.5	2.4	2.5	2.0	3.5	3.1	<1.5	<1.5	ug/l	TM30/PM14
Dissolved Zinc #	23	42	68	37	45	20	22	38	46	37	<3	ug/l	TM30/PM14
Total Hardness Dissolved (as CaCO ₃)	242	178	100	133	113	153	174	138	112	122	<1	mg/l	TM30/PM14
PAH MS													
Naphthalene #	<0.014	<0.014	<0.014	<0.014	<0.014	0.184	<0.014	<0.014	<0.014	<0.014	<0.014	ug/l	TM4/PM30
Acenaphthylene #	<0.013	0.030	0.050	<0.013	<0.013	<0.013	<0.013	<0.013	<0.013	<0.013	<0.013	ug/l	TM4/PM30
Acenaphthene #	<0.013	0.040	0.070	<0.013	<0.013	<0.013	<0.013	<0.013	<0.013	<0.013	<0.013	ug/l	TM4/PM30
Fluorene #	<0.014	0.050	0.060	<0.014	<0.014	<0.014	<0.014	<0.014	<0.014	<0.014	<0.014	ug/l	TM4/PM30
Phenanthrene #	0.020	0.050	0.060	0.020	0.030	0.070	0.030	0.020	0.020	0.030	<0.011	ug/l	TM4/PM30
Anthracene #	<0.013	0.020	0.020	<0.013	<0.013	<0.013	<0.013	<0.013	<0.013	<0.013	<0.013	ug/l	TM4/PM30
Fluoranthene #	<0.012	0.020	0.020	<0.012	<0.012	0.020	<0.012	<0.012	0.020	<0.012	<0.012	ug/l	TM4/PM30
Pyrene #	<0.013	0.020	0.020	<0.013	<0.013	0.030	<0.013	<0.013	0.020	<0.013	<0.013	ug/l	TM4/PM30
Benzo(a)anthracene #	<0.015	0.020	0.020	<0.015	0.020	0.030	<0.015	<0.015	0.020	0.020	<0.015	ug/l	TM4/PM30
Chrysene #	<0.011	0.020	0.020	<0.011	<0.011	0.020	<0.011	<0.011	0.020	<0.011	<0.011	ug/l	TM4/PM30
Benzo(bk)fluoranthene #	<0.018	0.020	<0.018	<0.018	<0.018	0.030	<0.018	<0.018	<0.018	<0.018	<0.018	ug/l	TM4/PM30
Benzo(a)pyrene #	<0.016	<0.016	<0.016	<0.016	<0.016	<0.016	<0.016	<0.016	<0.016	<0.016	<0.016	ug/l	TM4/PM30
Indeno(123cd)pyrene #	<0.011	<0.011	<0.011	<0.011	<0.011	<0.011	<0.011	<0.011	<0.011	<0.011	<0.011	ug/l	TM4/PM30
Dibenzo(ah)anthracene #	<0.01	<0.01	<0.01	<0.01	<0.01	<0.01	<0.01	<0.01	<0.01	<0.01	<0.01	ug/l	TM4/PM30
Benzo(ghi)perylene #	<0.011	<0.011	<0.011	<0.011	<0.011	<0.011	<0.011	<0.011	<0.011	<0.011	<0.011	ug/l	TM4/PM30
PAH 16 Total #	<0.195	0.290	0.340	<0.195	<0.195	0.384	<0.195	<0.195	<0.195	<0.195	<0.195	ug/l	TM4/PM30
Benzo(b)fluoranthene	<0.01	0.01	<0.01	<0.01	<0.01	0.02	<0.01	<0.01	<0.01	<0.01	<0.01	ug/l	TM4/PM30
Benzo(k)fluoranthene	<0.01	<0.01	<0.01	<0.01	<0.01	<0.01	<0.01	<0.01	<0.01	<0.01	<0.01	ug/l	TM4/PM30
PAH Surrogate % Recovery	90	90	91	96	95	91	92	90	89	91	<0	%	TM4/PM30
EPH (C8-C40) #	<10	<10	<10	<10	<10	<10	<10	<10	<10	<10	<10	ug/l	TM5/PM30

Client Name: Golder Associates Africa Ltd
Reference: CN00C 12614848
Location: Kingfisher
Contact: Jennifer Pretorius
JE Job No.: 14/4273

Report : Liquid

Liquids/products: V=40ml vial, G=glass bottle, P=plastic bottle
 H=H₂SO₄, Z=ZnAc, N=NaOH, HN=HNO₃

J E Sample No.	1-5	6-10	11-15	16-20	21-25	26-30	31-35	36-40	41-45	46-50	Please see attached notes for all abbreviations and acronyms		
Sample ID	SW02	SW03	SW09	SW14	SW15	SW17	SW19	SW20	SW21	SW22			
Depth													
COC No / misc													
Containers	H HN P G	H HN P G	H HN P G	H HN P G	H HN P G	H HN P G	H HN P G	H HN P G	H HN P G	H HN P G			
Sample Date	20/03/2014	20/03/2014	21/03/2014	23/03/2014	23/03/2014	23/03/2014	22/03/2014	23/03/2014	24/03/2014	24/03/2014			
Sample Type	Surface Water	Surface Water	Surface Water	Surface Water	Surface Water	Surface Water	Surface Water	Surface Water	Surface Water	Surface Water			
Batch Number	1	1	1	1	1	1	1	1	1	1			
Date of Receipt	27/03/2014	27/03/2014	27/03/2014	27/03/2014	27/03/2014	27/03/2014	27/03/2014	27/03/2014	27/03/2014	27/03/2014	LOD/LOR	Units	Method No.
GRO (>C4-C8) #	<10	<10	<10	<10	<10	<10	<10	<10	<10	<10	<10	ug/l	TM36/PM12
GRO (>C8-C12) #	<10	<10	<10	<10	<10	<10	<10	<10	<10	<10	<10	ug/l	TM36/PM12
GRO (>C4-C12) #	<10	<10	<10	<10	<10	<10	<10	<10	<10	<10	<10	ug/l	TM36/PM12
Fluoride	1.3	1.2	0.5	0.5	0.7	0.8	1.0	0.5	<0.3	<0.3	<0.3	mg/l	TM27/PM0
Sulphate #	47.92	16.75	4.65	0.27	0.34	0.20	5.92	11.38	7.43	7.75	<0.05	mg/l	TM38/PM0
Chloride #	11.7	7.4	1.4	14.7	2.6	4.5	4.6	19.9	5.8	7.7	<0.3	mg/l	TM38/PM0
Ortho Phosphate as PO4 #	2.11	1.18	0.17	0.09	0.36	0.70	0.88	<0.06	0.75	0.31	<0.06	mg/l	TM38/PM0
Nitrate as N #	0.19	0.29	0.15	<0.05	0.09	0.27	0.23	<0.05	0.21	0.15	<0.05	mg/l	TM38/PM0
Ammoniacal Nitrogen as N #	0.22	0.47	0.25	0.59	0.09	0.50	0.19	0.08	0.44	0.56	<0.03	mg/l	TM38/PM0
Total Alkalinity as CaCO3 #	416	308	146	178	160	232	274	302	134	136	<1	mg/l	TM75/PM0
Electrical Conductivity @25C #	853	621	274	377	330	469	517	648	319	320	<2	uS/cm	TM76/PM0
pH #	8.79	8.88	8.48	6.76	8.36	8.55	8.72	8.87	7.32	7.03	<0.01	pH units	TM73/PM0
Silica	27.60	26.80	32.90	27.10	28.00	13.80	30.00	2.40	33.30	21.00	<0.01	mg/l	TM52/PM0
Total Dissolved Solids	506	363	158	217	183	231	302	326	187	176	<10	mg/l	TM20/PM0

NOTES TO ACCOMPANY ALL SCHEDULES AND REPORTS

JE Job No.: 14/4273

SOILS

Please note we are only MCERTS accredited for sand, loam and clay and any other matrix is outside our scope of accreditation.

Where an MCERTS report has been requested, you will be notified within 48 hours of any samples that have been identified as being outside our MCERTS scope. As validation has been performed on clay, sand and loam, only samples that are predominantly these matrices, or combinations of them will be within our MCERTS scope. If samples are not one of a combination of the above matrices they will not be marked as MCERTS accredited.

It is assumed that you have taken representative samples on site and require analysis on a representative subsample. Stones will generally be included unless we are requested to remove them.

All samples will be discarded one month after the date of reporting, unless we are instructed to the contrary. If we are instructed to keep samples, a storage charge of £1 (1.5 Euros) per sample per month will be applied until we are asked to dispose of them.

If you have not already done so, please send us a purchase order if this is required by your company.

Where appropriate please make sure that our detection limits are suitable for your needs, if they are not, please notify us immediately.

All analysis is reported on a dry weight basis unless stated otherwise. Results are not surrogate corrected. Samples are dried at 35°C ±5°C unless otherwise stated. Moisture content for CEN Leachate tests are dried at 105°C ±5°C.

Where Mineral Oil or Fats, Oils and Grease is quoted, this refers to Total Aliphatics C10-C40.

Where a CEN 10:1 ZERO Headspace VOC test has been carried out, a 10:1 ratio of water to wet (as received) soil has been used.

WATERS

Please note we are not a Drinking Water Inspectorate (DWI) Approved Laboratory. It is important that detection limits are carefully considered when requesting water analysis.

UKAS accreditation applies to surface water and groundwater and one other matrix which is analysis specific, any other liquids are outside our scope of accreditation.

As surface waters require different sample preparation to groundwaters the laboratory must be informed of the water type when submitting samples.

Where Mineral Oil or Fats, Oils and Grease is quoted, this refers to Total Aliphatics C10-C40.

DEVIATING SAMPLES

Samples must be received in a condition appropriate to the requested analyses. All samples should be submitted to the laboratory in suitable containers with sufficient ice packs to sustain an appropriate temperature for the requested analysis. If this is not the case you will be informed and any test results that may be compromised highlighted on your deviating samples report.

SURROGATES

Surrogate compounds are added during the preparation process to monitor recovery of analytes. However low recovery in soils is often due to peat, clay or other organic rich matrices. For waters this can be due to oxidants, surfactants, organic rich sediments or remediation fluids. Acceptable limits for most organic methods are 70 - 130% and for VOCs are 50 - 150%. When surrogate recoveries are outside the performance criteria but the associated AQC passes this is assumed to be due to matrix effect. Results are not surrogate corrected.

NOTE

Data is only reported if the laboratory is confident that the data is a true reflection of the samples analysed. Data is only reported as accredited when all the requirements of our Quality System have been met. In certain circumstances where all the requirements of the Quality System have not been met, for instance if the associated AQC has failed, the reason is fully investigated and documented. The sample data is then evaluated alongside the other quality control checks performed during analysis to determine its suitability. Following this evaluation, provided the sample results have not been effected, the data is reported but accreditation is removed. It is a UKAS requirement for data not reported as accredited to be considered indicative only, but this does not mean the data is not valid.

Where possible, and if requested, samples will be re-extracted and a revised report issued with accredited results. Please do not hesitate to contact the laboratory if further details are required of the circumstances which have led to the removal of accreditation.

ABBREVIATIONS and ACRONYMS USED

#	UKAS accredited.
B	Indicates analyte found in associated method blank.
DR	Dilution required.
M	MCERTS accredited.
NA	Not applicable
NAD	No Asbestos Detected.
ND	None Detected (usually refers to VOC and/SVOC TICs).
NDP	No Determination Possible
SS	Calibrated against a single substance.
SV	Surrogate recovery outside performance criteria. This may be due to a matrix effect.
W	Results expressed on as received basis.
+	AQC failure, accreditation has been removed from this result, if appropriate, see 'Note' on previous page.
++	Result outside calibration range, results should be considered as indicative only and are not accredited.
*	Analysis subcontracted to a Jones Environmental approved laboratory.
CO	Suspected carry over
OC	Outside Calibration Range
NFD	No Fibres Detected
LOD/LOR	Limit of Detection (Limit of Reporting) in line with ISO 17025 and MCERTS

JE Job No: 14/4273

Test Method No.	Description	Prep Method No. (if appropriate)	Description	UKAS	MCERTS (soils only)	Analysis done on As Received (AR) or Air Dried (AD)	Reported on dry weight basis
TM4	16 PAH by GC-MS, modified USEPA 8270	PM30	In-house method based on USEPA 3510. Liquid samples are mixed with solvent and agitated with an automatic magnetic stirrer with a stir bar for 15 minutes to extract organic molecules. ISO 17025 accredited extraction method. All accreditation is matrix specific				
TM4	16 PAH by GC-MS, modified USEPA 8270	PM30	In-house method based on USEPA 3510. Liquid samples are mixed with solvent and agitated with an automatic magnetic stirrer with a stir bar for 15 minutes to extract organic molecules. ISO 17025 accredited extraction method. All accreditation is matrix specific	Yes			
TM5	In-House method based on USEPA 8015B. Determination of Extractable Petroleum Hydrocarbons (EPH) in the carbon chain length range of C8-40 by GC-FID. Accredited to ISO 17025 on soil and water samples and MCERTS (carbon banding only) on soils. All accreditation is matrix specific.	PM30	In-house method based on USEPA 3510. Liquid samples are mixed with solvent and agitated with an automatic magnetic stirrer with a stir bar for 15 minutes to extract organic molecules. ISO 17025 accredited extraction method. All accreditation is matrix specific	Yes			
TM20	TDS, TSS and TS - gravimetric	PM0	No preparation is required.				
TM27	In-House method based on USEPA 9056. Analysis of samples using a Dionex Ion-Chromatograph instrument.	PM0	No preparation is required.				
TM30	Trace Metal elements by ICP-OES (Inductively Coupled Plasma - Optical Emission Spectrometry) using Thermo iCAP 6000 series instrument. Accredited to ISO 17025 for soils and waters and MCERTS accredited for Soils. All accreditation is matrix specific.	PM14	In-house method based on USEPA 3005A. Acid digestion of water samples and analysis by ICP-OES as per method TM030W.ISO 17025 accredited extraction method. All accreditation is matrix specific				
TM30	Trace Metal elements by ICP-OES (Inductively Coupled Plasma - Optical Emission Spectrometry) using Thermo iCAP 6000 series instrument. Accredited to ISO 17025 for soils and waters and MCERTS accredited for Soils. All accreditation is matrix specific.	PM14	In-house method based on USEPA 3005A. Acid digestion of water samples and analysis by ICP-OES as per method TM030W.ISO 17025 accredited extraction method. All accreditation is matrix specific	Yes			
TM36	In-House method based on USEPA 8015B. Determination of Gasoline Range Organics (GRO) in the carbon chain range of C5-12 by headspace GC-FID. Accredited to ISO 17025 on soil and water samples and MCERTS accredited (carbon banding only) on soils. All accreditation is matrix specific.	PM12	In-house method based on USEPA 5021. Preparation of solid and liquid samples for headspace analysis. Samples are spiked with surrogates to facilitate quantification. ISO 17025 accredited extraction method. All accreditation is matrix specific	Yes			
TM38	Ionic analysis using the Thermo Aquakem Photometric Automatic Analyser. Accredited to ISO17025 and MCERTS for most analytes. All accreditation is matrix specific.	PM0	No preparation is required.	Yes			
TM52	Silica by Spectrophotometer	PM0	No preparation is required.				

JE Job No: 14/4273

Test Method No.	Description	Prep Method No. (if appropriate)	Description	UKAS	MCERTS (soils only)	Analysis done on As Received (AR) or Air Dried (AD)	Reported on dry weight basis
TM73	pH in by Metrohm	PM0	No preparation is required.	Yes			
TM75	Alkalinity by Metrohm	PM0	No preparation is required.	Yes			
TM76	Electrical Conductivity by Metrohm	PM0	No preparation is required.	Yes			



February 2018

REPORT – VOLUME 4, STUDY 3

CNOOC UGANDA LIMITED

KINGFISHER OIL PROJECT, HOIMA DISTRICT, UGANDA - GROUNDWATER SPECIALIST STUDY

Submitted to:

The Executive Director National Environment Management Authority, NEMA House,
Plot 17/19/21 Jinja Road, P. O. Box 22255 Kampala, Uganda



Report Number: 1776816-321513-14

Distribution:

- 1 x electronic copy CNOOC Uganda Limited
- 1 x electronic copy NEMA
- 1 x electronic copy Eco & Partner
- 1 x electronic copy Golder





Executive Summary

The **objectives** of the groundwater investigation are to:

- Understand the baseline groundwater regime at the proposed facility from available information;
- Establish the baseline groundwater quality profile; and
- Use the available groundwater information to predict potential groundwater impacts during construction, operation, and decommissioning.

The specialist study was based on available groundwater information and a hydrocensus around the area. The approach is designed to give a broad overview of the site conditions and available information as well as to identify gaps in the understanding of the current geohydrological regime. In the event that insufficient information is available, or that the data sets are not applicable to the area under investigation, additional work may be required. The study included the following tasks:

- Site Familiarisation and client liaison
- Desk study.
- Hydrocensus and water sampling
- Data Processing and Evaluation

During the desk study several reports (provided by CNOOC) were used for background information to the project. These included numerous standards, guidelines and existing and approved EIA's relevant to the project area. Government groundwater database data was also accessed to fill information gaps and provide regional level input.

Field investigations in this case were limited to a site familiarisation visit and two hydrocensus surveys for the project site. No other field investigations were performed. The hydrocensus was completed in two stages during December 2013 and March 2014. The first field trip involved the collection of groundwater, spring, stream, and lake water samples along the lake front of Lake Albert in the area directly affected by the Kingfisher project. During the March 2014 field trip, duplicate water samples were taken from the groundwater wells along the lake front to include petroleum hydrocarbon analyses for the establishment of a water quality baseline for these parameters. In addition a hydrocensus was completed along the pipeline route and through all communities that could potentially be affected by the activities and groundwater samples were taken from wells. A total of 14 samples were taken at the lake front, and another 15 were taken on the escarpment along the pipeline route. Water level measurements were limited to two unused wells near the camp site.

The Kingfisher field is formed by a structural trap, which comprises a southwest-northeast trending 3-way dip-closed hanging-wall anticline that seals against basement to the south-east along the main bounding fault of the Albert Basin. The field is about 10km by 2km and provided the drilling sites for 3 wells and 3 side-tracks (CNOOC, 2014). The sedimentary succession of Kingfisher is composed of intervals of Late Miocene and Pliocene age. The sequence comprises a series of interbedded sandstones and shales, representing a mixture of low-stand events, during which sedimentation was dominated by fluvial processes and flood or high-stand events when lacustrine deposition predominated.

The **groundwater resources** at the Kingfisher Project site and associated pipeline infrastructure can be summarised as followed:

- On the Buhuka flat and lake front villages (only 5 out of the 10 villages) the groundwater is utilised as a source of domestic water through shallow wells and deeper installed wells. Most are equipped with hand pumps and sealed at surface;



GROUNDWATER SPECIALIST STUDY

- Wells are prone to fail due to corrosive properties of the groundwater (i.e. often the pipes are corroded away, if not maintained). The villagers conveyed that wells often do not yield enough water or that water quality is too poor for use. As an alternative, villagers augment their water supply with lake water and/or springs or streams against the escarpment;
- The groundwater is assumed to be associated with the bedrock formations consisting of granite, gneiss or quartzite formations on the escarpment and with sediments such as sandstone down at the lake front;
- Water level elevations were interpolated for the area, and static water levels showed great variation between 1m to 63m below ground level. The variability in water levels confirms the fractured and thus heterogeneous character of the aquifers;
- General groundwater flow direction in the KP area is towards Lake Albert in a north-westerly direction;
- Water quality on the Buhuka flats are very poor and characterised by very high salinity (and corrosive character) caused by accumulation of salts from evapotranspiration and seasonal water fluctuations;
- Water quality along the escarpment villages was generally acceptable with some trace metals exceeding the drinking water guidelines;
- No organic (petroleum) hydrocarbons were detected in any of the samples; and
- Microbial water quality was very poor and most of the water sources including the lake water tested positive for Coliforms and E.coli. The cause of this is most likely due to poor or non-existing sanitation practices.

The **potential impacts** on the groundwater systems were determined for the construction and operational phases of Kingfisher Well Field Development, with a significance rating for each impact before and after mitigation

The **construction phase activities** that could potentially impact on the groundwater resource include activities associated with materials handling, water demand, and waste generation during the construction of the various components of the project (i.e. residential camps, CPF, pipeline and well pads). All these activities can result in pollution of groundwater resources. The following table summarises the potential construction impacts:

Receptor	Description	Type of Impact	Pre-mitigation			Post-mitigation		
			Sensitivity	Magnitude of Impact	Impact Significance	Sensitivity	Magnitude of Impact	Impact Significance
Groundwater	Pollution from domestic waste water discharge	Direct	Medium	Medium	9 Moderate	Low	Low	4 Minor
Groundwater	Pollution from sanitation waste - well pads and pipeline construction	Direct	Medium	Medium	9 Moderate	Low	Low	4 Minor
Groundwater	Pollution from accidental spills from	Direct	High	Medium	12 Major	Low	Low	4 Minor



GROUNDWATER SPECIALIST STUDY

Receptor	Description	Type of Impact	Pre-mitigation			Post-mitigation		
			Sensitivity	Magnitude of Impact	Impact Significance	Sensitivity	Magnitude of Impact	Impact Significance
	materials handling				12			4
Groundwater	Pollution from waste generated during vehicle maintenance	Direct	High	Medium	12 Major	Low	Low	4 Minor
Groundwater	Pollution from domestic waste disposal	Direct	Medium	Medium	9 Moderate	Low	Low	4 Minor
Groundwater	Pollution from drill wastes - management and disposal	Direct	Medium	Medium	9 Moderate	Low	Medium	6 Moderate
Groundwater	Pollution from well blow-out	Direct	High	High	16 Major	Medium	Medium	9 Moderate

The **operational phase** of the Kingfisher project covers the Kingfisher production and transmission system from outlet of the well Christmas choke valves; to inlet flange of delivery point; and include the following elements:

- Well pads;
- Flowlines;
- Central Process Facilities (CPF);
- Crude oil Pipeline;
- Lake Water Extracting Station; and
- Infrastructure (camps, roads, buildings, etc.).

The impacts associate with these elements will be groundwater pollution caused by generation of domestic waste and waste water discharge; waste generation during the maintenance of equipment and machinery; hazardous waste; accidental spills of materials stored and handled, inadequate drainage management; well drilling; pipeline or flowline failure; and well blow out. The impacts associated with a catastrophic well blow out or pipeline failure poses potentially the largest risk to the groundwater resources. However, incidents of that nature are unlikely under good operational conditions and mitigation measures will be in place to prevent such incidents. Potential impacts are summarised in table below:



GROUNDWATER SPECIALIST STUDY

Receptor	Description	Type of Impact	Pre-mitigation			Post-mitigation		
			Sensitivity	Magnitude of Impact	Impact Severity	Sensitivity	Magnitude of Impact	Impact Severity
Groundwater	Pollution from domestic waste water discharge	Direct	Medium	Medium	9 Moderate	Low	Low	4 Minor
Groundwater	Pollution from accidental spills from materials handling	Direct	High	High	16 Major	High	Low	8 Moderate
Groundwater	Pollution from waste generated during flow line and CPF maintenance activities	Direct	Medium	Medium	9 Moderate	Medium	Low	6 Moderate
Groundwater	Inadequate drainage/stormwater management	Indirect	Medium	Medium	9 Moderate	Medium	Very Low	3 Minor
Groundwater	Pollution from solid waste generation	Direct	High	Medium	12 Major	Medium	Low	6 Moderate
Groundwater	Production Waste Generated on the Well pad	Direct	Medium	Medium	9 Moderate	Low	Low	4 Minor
Groundwater	Pollution from Produced Water Injection	Direct	High	High	16 Major	Medium	Medium	9 Moderate
Groundwater	Pollution from pipeline/flowline failure	Direct	High	High	16 Major	Medium	Medium	9 Moderate
Groundwater	Pollution from well blow-out	Direct	High	High	16 Major	Medium	Medium	9 Moderate

The severity and occurrence of the impacts expected on groundwater resources can be reduced to minor in most cases with applied **mitigation measures**. All mitigation measures recommended, takes cognisance of the IFC Standards, together with the relevant Ugandan legislative requirements, CNOOC's in-house environmental specifications and acceptable industry best practice.

Impacts are mostly related to waste water and solid waste generation during the construction phase and mitigation measures typically consist of management plans to handle hazardous materials, waste and waste water to reduce the impacts.

Pipeline failures can be prevented by choosing the right materials suited to the product transported, equipment and appropriate maintenance and testing of the pipeline. Hydrostatic testing by which the pipeline is subjected to pressure above the operating pressure, to blow out defects before they reach a critical size in service should also be used to detect corroded pipe before it fails in service. A pipeline integrity strategy should be compiled; to guide inspection and preventive maintenance to ensure the integrity of the pipeline



The drilling fluid is the primary safeguard against blow-out of hydrocarbons from a well and its density can be controlled to balance any anticipated formation pressures. The drilling mud will be tested from time-to-time during the drilling process and its composition adjusted to account for any changing down-hole conditions. The mud density will be adjusted as required by an on-site chemist. The likelihood of a blow-out will be further minimized by using a specially designed blow-out preventer (BOP). When installed on top of the well-bore, a BOP will close the well automatically in case of a blowout. A management plan needs to be in place in case of a catastrophic well blow-out and or pipeline failure. Such a management plan needs to include measures to clean-up soils and groundwater.

The most important mitigation measure for potential impacts to groundwater will be monitoring of the groundwater systems. This will only be accomplished by installation of dedicated groundwater monitoring wells. The monitoring network should be concentrated at the KP area and should include community wells. The installation of the network should be done during the construction phase of the project. The spatial distribution, depth, and construction of the wells will be dependent on the identified waste sources and final infrastructure distribution. The monitoring system needs to be designed to monitor all identified potential sources of groundwater contamination on the Kingfisher Project area (CPF, well pads, flow lines and accommodation camps). This will ideally include the installation of monitoring wells up- and down-gradient of all activities/sources that could result in potential groundwater pollution. Frequencies of sampling and required analytical parameters need to be discussed with the relevant Regulatory Authority. It is recommended, based on similar project experience, to sample wells quarterly, and to analyse for all the parameters included in the hydrochemical evaluation of this report.



Table of Contents

1.0	INRODUCTION	1
1.1	Background	1
1.2	Objectives of the study	3
2.0	LEGAL FRAMEWORK	3
2.1	Approach and Methodology	5
2.1.1	Site Familiarisation	6
2.1.2	Client Liaison	6
2.1.3	Desk Study	6
3.0	PROJECT SUMMARY	11
3.1	CPF, wells flowlines and associated infrastructure	11
3.2	Feeder pipeline	11
4.0	FIELD INVESTIGATIONS	12
5.0	BASELINE ENVIRONMENT	18
5.1	Climate	18
5.1.1	Rainfall	18
5.1.2	Temperature and humidity	18
5.1.3	Wind	18
5.2	Topography and Drainage	18
5.3	Geology	19
5.3.1	Regional Geology	19
5.3.2	Local Geology	22
5.4	Hydrogeology	23
5.4.1	Regional Hydrogeology	23
5.4.2	Site Hydrogeology	23
5.4.3	Groundwater Quality	25
5.4.3.1	Physical Parameters	26
5.4.3.2	Macro Chemistry	36
5.4.3.3	Micro Chemistry	37
5.4.3.4	Organic Chemistry	37
5.4.3.5	Microbial Water Quality	44





5.4.4	Hydrogeological Conceptual Model	46
6.0	IMPACT ASSESSMENT.....	48
6.1	Impact Assessment Rating of Potential Impacts.....	48
6.2	Construction Phase Impacts.....	50
6.2.1	Abstraction of groundwater for potable use.....	50
6.2.2	Generation of domestic waste water discharge	51
6.2.3	Generation of sanitation waste– well pads and pipeline construction	51
6.2.4	Waste generated during the maintenance of equipment and machinery	51
6.2.5	Accidental spills of materials stored and handled	52
6.2.6	Domestic Waste generation	52
6.2.7	Well drilling.....	52
6.3	Operational Phase Impacts	55
6.3.1	Generation of domestic waste water discharge	56
6.3.2	Solid Waste Generation	57
6.3.3	Accidental spills of materials stored and handled	58
6.3.4	Waste generated during flow line and CPF maintenance activities.....	58
6.3.5	Inadequate drainage/stormwater management.....	58
6.3.6	Production Waste Generated on the Well pad.....	59
6.3.7	Produced Water Injection.....	59
6.3.8	Pipeline or Flowline Failure	60
6.3.9	Well Failure or Blow-out.....	60
6.4	Cumulative Impacts	63
6.5	Residual impacts	63
7.0	MITIGATION MEASURES.....	63
7.1	Construction Phase Mitigation	63
7.2	Operational Phase Mitigation.....	69
8.0	CLOSURE.....	73
9.0	ASSUMPTIONS AND LIMITATIONS	74
10.0	REFERENCES.....	75

TABLES

Table 1: Terminology and Acronyms.....	1
Table 2: Information sources - Reports	6





Table 3: Hydrocensus summary.....	14
Table 4: Follow up field survey results	17
Table 5: Field parameters measured at wells and springs along the lake front (2014)	24
Table 6: Field chemical parameters recorded for samples along the pipeline route (2015)	25
Table 8: Macro Constituents (units in mg/L unless otherwise stated)	30
Table 9: Micro constituents (units in mg/L unless otherwise stated)	38
Table 10: Colitag™ test results	44
Table 11: Types of Potential Groundwater Impacts	48
Table 12: Determination of impact significance.....	49
Table 13: Impact assessment criteria and rating scale	49
Table 14: Construction Phase Impacts	54
Table 15: Specification for injection of produced water	59
Table 16: Operation Phase Impacts.....	61
Table 17: Standards for Discharge of Effluent.....	63
Table 18: Wastes generated on the Kingfisher well pads during the drilling phase.....	66
Table 19: Mitigation Summary - Construction Phase	69
Table 20: Standards for Discharge of Effluent.....	70
Table 21: Hazardous production wastes generated at the CPF during the operational phase.....	71
Table 22: Non-hazardous waste generated at the CPF during the operational phase (including wastes from the permanent camp)	71
Table 23: Mitigation Summary - Operation Phase.....	73

FIGURES

Figure 1: Regional Location of the Kingfisher Project Site	2
Figure 2: Distribution of data points – well/boreholes locations, Golder (2013) Groundwater Baseline Report for Kingfisher Block 3A	9
Figure 3: Location of the hydrocensus points surveyed	10
Figure 4: Infrastructure at Kingfisher Development Area	12
Figure 5: Follow up survey of wells in villages, indicated on the original baseline map backdrop to indicate clearly which boreholes were revisited	16
Figure 6: Regional Geological Map (adapted from Geological maps produced by Department of Geological Survey and Mines, 2012)	20
Figure 7: Water elevation map for the Kingfisher Project area	21
Figure 8: Sedimentary Sucession at Kingfisher (CNOOC, 2014)	22
Figure 9: Typical well installation in the Kingfisher project area	24
Figure 10: Piper diagram for the groundwater samples	36
Figure 11: Site hydrogeological conceptualisation from Atkins, 2010	47
Figure 12: The solid waste management hierarchy.....	64





Figure 13: Drilling waste process and recycle flow chart..... 67

APPENDICES

APPENDIX A

Chemical Analytical Results

APPENDIX B

Microbial Results



Table 1: Terminology and Acronyms

Acronym	Description
BOP	Blow-out preventer
BVS	Block Valve Station
CLOs	Community Liaison Officers
CNOOC	China National Offshore Oil Corporation
CPF	Central Processing Facility
DRC	Democratic Republic of Congo
DWRM	Directorate of Water Resources Management
EA	Exploration Areas
EBS	Environmental Baseline Study
EC	Electrical Conductivity
EHS	Environmental, Health, and Safety
EIA	Environmental Impact Assessment
EIS	Environmental Impact Statement
ESIA	Environmental and Social Impact Assessment
ESIS	Environmental and Social Impact Statement
ESMP	Environmental and Social Management Plan
IFC	International Finance Corporation
KF	Kingfisher
LPG	Liquefied Petroleum Gas
LSA	Local Study Area
mamsl	Metres above mean sea level
mbgl	Metres below ground level
MD	Maximum Depth
MEMD	Ministry of Energy and Mineral Development
NEMA	National Environment Management Authority
MPN	Most Probable Number
NGO	Non-governmental Organisations
NTU	Nephelometric Turbidity Units
OGP	International Association of Oil and Gas Producers
PAH	Poly aromatic hydrocarbons
PEPD	Petroleum Exploration and Production Department
PLDS	Pipeline Leak detection System
PPE	Personal Protective Equipment
PS	Performance Standards
PSAs	Production Sharing Agreements
RTU	Remote Terminal Unit
SBM	Synthetic Based Drilling Mud
SOP	Standard Operating Procedures
SOW	Scope of Work
SPT	Sewage treatment plant
TDS	Total dissolved Solids



GROUNDWATER SPECIALIST STUDY

Acronym	Description
TPH	Total Petroleum hydrocarbons
TSS	Total Suspended Solids
TVD	Total vertical depth
VOC	Volatile Organic Compounds
VOIP	Voice over Internet Protocol
WBM	Water Based Mud
WHCP	Hydraulic Wellhead Control Panel
WRMD	Water Resource Management Directorate





1.0 INTRODUCTION

Golder Associates was appointed by China National Offshore Oil Corporation (CNOOC) to undertake a baseline and ESIA for its proposed Oil production operations in the Albertine Rift Valley in Western Uganda. This report represents the Groundwater Baseline Study for the Block EA 3A exploration area.

1.1 Background

The petroleum potential of Uganda was first documented by A.J. Wayland in 1925, based on oil seepages he mapped at that time. The first well, Waki-B1, was drilled in the Butiaba area in 1938 (NEMA, 2010). The Albertine Graben, the area with potential for petroleum accumulation, has since been subdivided into ten Exploration Areas. The Exploration Areas include blocks 1 and 5 located to the north of Lake Albert, blocks 2, 3A, 3B, 3C and 3D on and around Lake Albert, while blocks 4A, 4B and 4C are located around lakes Edward and George in the southern part of the Graben. Five out of these ten Exploration Areas are licensed to oil exploration companies for exploration, development and production.

Oil exploration and production activities so far indicate that the oil potential in this area is promising. For example, out of the 34 oil and gas wells that have been drilled, only 2 have been found without oil. The estimated reserves in the Albertine Graben as a whole are about 2 billion barrels. The size of the reserves is enough to sustain production for 20 years (NEMA, 2010).

CNOOC will operate the Kanywataba license and the Kingfisher production licence within EA-3A, Figure 1. Kingfisher discovery has three drilled wells, Kingfisher 1, 2 & 3 while Kanywataba prospect was recently drilled but found to be a dry well that was plugged and abandoned. There is a future plan to drill a fourth well, Kingfisher 4, to further appraise the Kingfisher oil field. The Kanywataba prospect will most likely be relinquished back to government in the last quarter of this year upon expiry of the license.

The Kingfisher oil field lies within the Kingfisher Development Area (KDA), mostly beneath Lake Albert, in a 15 km x 3 km area. The project will consist of the following components, located within two main areas:

- 1) The wells, flowlines, central processing facility (CPF) and supporting infrastructure. These will be situated on the Buhuka Flats in the Kingfisher Development Area (KDA), along the south-eastern side of Lake Albert. The subsurface construction will include a total of 31 wells, made up of 20 production wells and 11 produced water injection wells. The CPF will also produce fuel gas, used to supply all of the project's power requirements in the first 10 years, and LPG, which will be sold into the local market.
- 2) The export pipeline, which will transport the stabilised crude oil from the CPF to Kabaale, roughly 52 km to the northeast, to tie in at the site of a proposed oil refinery, planned by the Ugandan Government.

Project components that are excluded from this ESIA or which will be considered only as a part of the cumulative assessment of impacts, or as a due diligence assessment of a third-party supplier, are those that have already been permitted or are the responsibility of other parties:

- Waste sites for disposal of petroleum wastes.
- Transmission lines and substation infrastructure to export and import power.
- The pipeline linking the Kaiso - Tonya field to the CPF. This oil field is to be developed by Tullow Oil, but will be processed by the CPF. The environmental permitting for all aspects of Kaiso – Tonya are the responsibility of Tullow Oil.
- Some of the ancillary project infrastructure has already been licensed and built.



GROUNDWATER SPECIALIST STUDY

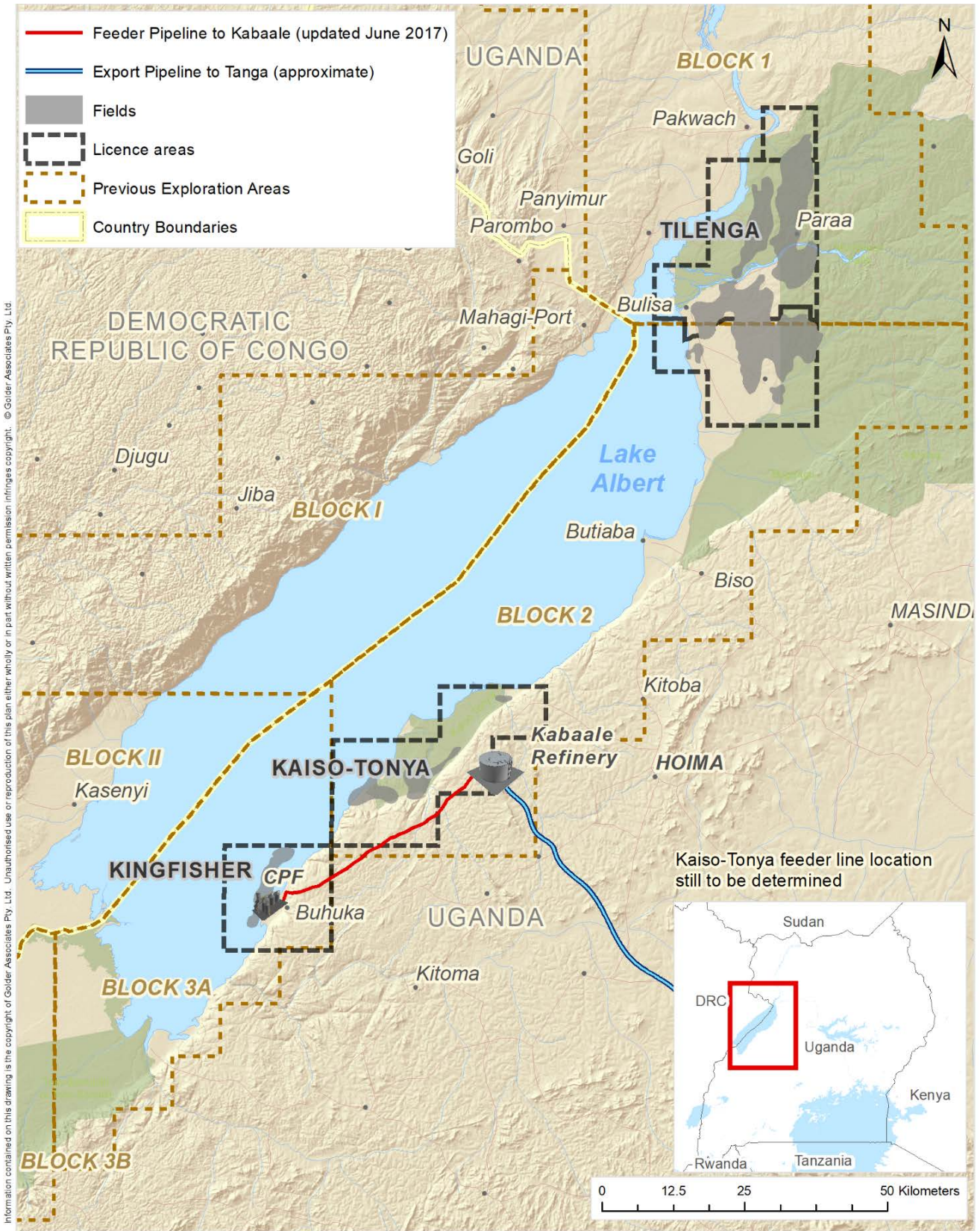

Figure 1: Regional Location of the Kingfisher Project Site





1.2 Objectives of the study

Generally, groundwater is the most important source of potable water in Uganda, and most especially in the rural areas, providing 80% or more of the water supply (British Geological Survey, 2001). Availability of data for groundwater in an aggregated format for different parts of the country is limited, resulting in a dearth of information for Hoima District in general and Buhuka Parish in particular. Nevertheless, villages on the Buhuka Flats do make use of groundwater from wells, although the larger villages receive water from the escarpment by a gravitational pipeline installed by the previous concession holders. In either case, the water is not treated and villagers express concern about the poor quality of domestic water.

The objectives of the groundwater investigation are to:

- Understand the baseline groundwater regime at the proposed facility and along the pipeline route from available information;
- Establish the baseline groundwater quality profile; and
- Use the available groundwater information to predict potential groundwater impacts during construction, operation, and decommissioning.

2.0 LEGAL FRAMEWORK

This section presents the summary of the international and national policy framework relevant to this *groundwater specialist study*. Other policies, laws, regulations, standards and guidelines relevant to the full ESIA may not be listed here and the reader is referred to the ESIA report. This section also identifies agencies, departments and institutions responsible for the monitoring and enforcement of legal requirements.

3) National environmental legislation relevant to groundwater is listed below:

- The Constitution of the Republic of Uganda, 1995;
- The National Environment Act, Cap 153, 1995;
- The National Environmental Impact Assessment Regulations, 1998 made under the National Environment Act, Cap 153;
- The National Environmental (Audit) Regulations, 2006 under the National Environment Act, Cap 153 of 1995;
- The Mining Act, 2003;
- Petroleum (Exploration and Production) Act Cap 150;
- Petroleum (Conduct of Exploration Operations Regulations, 1993 under the Petroleum exploration and production Act. Cap 150, 1985;
- The draft Petroleum Exploration, Development and Production Bill of 2012;
- The Water Act Cap 152;
- The National Environment (Waste Management Regulations 1999) under the National Environment Act Cap 153, 1995;
- The National Environment (Standards for Discharge of Effluent into Water or on Land) Regulations 1999 under the National Environment Act Cap 153, 1995;
- The Uganda Bureau of Standards (US 201) specification for Drinking (Potable Water) 1994; and
- Environmental Impact Assessment Guidelines for the Energy Sector, 2004.

4) National policies and guidelines relevant to groundwater are listed below:



- The Oil and Gas Policy 2008;
 - The National Environment Management Policy 1994;
 - The National Water Policy 1999; and
 - The National Energy Policy 2002.
- 5) **Several institutions are relevant stakeholders in the Kingfisher Discovery Area Project. The major ones include (but are not limited to) the following:**

- The Ministry of Water and Environment;
- Ministry of Justice and Constitutional Affairs;
- The National Environment Management Authority (NEMA); and
- The Water Resources Management Authority (WRMA).

6) **International Finance Corporation (IFC):**

CNOOC is committed to the International Finance Corporation (IFC) performance standards (PS) on social and environmental sustainability. These were developed by the IFC and were last updated on 1st January 2012. The PS comprise of eight performance standards namely:

- Performance Standard 1: Assessment and Management of Environmental and Social Risks and Impacts;
- Performance Standard 2: Labour and Working Conditions;
- Performance Standard 3: Resource Efficiency and Pollution Prevention;
- Performance Standard 4: Community Health, Safety and Security;
- Performance Standard 5: Land Acquisition and Involuntary Resettlement;
- Performance Standard 6: Biodiversity Conservation and Sustainable Management of Living Natural Resources;
- Performance Standard 7: Indigenous Peoples; and
- Performance Standard 8: Cultural Heritage.

Performance Standard 1 establishes the importance of:

- (i) integrated assessment to identify the social and environmental impacts, risks, and opportunities of projects;
- (ii) effective community engagement through disclosure of project-related information and consultation with local communities on matters that directly affect them; and
- (iii) the management of social and environmental performance throughout the life of a project through an effective Environmental and Social Management System (ESMS).

PS 1 is the overarching standard to which all the other standards relate. The ESMS should be designed to incorporate the aspects of PS 2 to 8 as applicable.

The Equator Principles (EPs) constitute a credit risk management framework for determining, assessing and managing environmental and social risk in Project Finance transactions. Project Finance is often used to fund the development and construction of major infrastructure and industrial projects. The EPs are adopted by financial institutions and are applied where total project capital costs exceed US\$10 million. The EPs are primarily intended to provide a minimum standard for due diligence to support responsible risk decision-making. The EPs are based on the International Finance Corporation Performance Standards on social and



environmental sustainability and on the World Bank Group Environmental, Health, and Safety Guidelines (EHS Guidelines).

IFC General Environmental Health and Safety (EHS) Guidelines (World Bank Group, 2007) are technical reference documents with general and industry specific examples of Good International Industry Practice (GIIP). Reference to the EHS guidelines is required under IFC PS 3. The EHS Guidelines contain the performance levels and measures normally acceptable to the IFC and are generally considered to be achievable in new facilities at reasonable cost. When host country regulations differ from the levels and measures presented in the EHS Guidelines, projects are expected to achieve whichever standard is more stringent.

7) Applicable CNOOC Internal Procedures and Specifications:

The following internal CNOOC Procedures and Specifications were considered during the compilation of this Baseline and Impact Assessment.

- Lake Region Operations Management Specification - The purpose of this specification is to guide the delivery of site and activity specific environmental and social impact assessments, environmental management plans for Company's activities in the Albertine Graben.
- Environmental Management Procedure - The purpose of this procedure is to ensure that all environmental issues are managed properly to avoid adverse impacts on environment or human health during all operations. The specification applies to the Company's activities during exploration operations and construction activities.
- Environmental Monitoring Management Specification - The purpose of this specification is to track environmental performance; assess implementation and effectiveness of operational controls; monitor discharges and emissions to ensure compliance with relevant standards and Company's environmental objectives; and provide a basis for continuous review and improvement to the operational monitoring program.
- Spill Prevention and Control Specification - The purpose of this specification is to undertake necessary measures to prevent accidental spills or releases of hazardous materials such as petroleum, acid or alkali.
- Waste Management Specification - The purpose of this specification is to assure that the Company will properly and safely manage all non-hazardous and hazardous waste, from its generation to ultimate disposition, to prevent/minimize risks to human health and the environment. Terms of Reference

2.1 Approach and Methodology

As described in detail in the RFP document supplied by CNOOC, the requirement to undertake the requested baseline study and subsequent ESIA is essential to provide sufficient understanding of the groundwater environment and potential impact on this environment surrounding the proposed operational areas. To undertake this during the feasibility stages of the project at a time when the findings and recommendations of the ESIA are still able to influence design decisions and mitigation measures is essential given the environmental value of the area.

The specialist study was based on available groundwater information and a hydrocensus around the area. The approach is designed to give a broad overview of the site conditions and available information as well as to identify gaps in the understanding of the current hydrogeological regime. In the event that insufficient information is available, or that the data sets are not applicable to the area under investigation, additional work may be required.

The study included the following tasks:



2.1.1 Site Familiarisation

The project kick-off comprised of a site familiarisation visit by the hydrogeology team. The site visit provided the opportunity to make contact with the relevant role players for the project and to identify the correct contacts to obtain relevant existing information.

2.1.2 Client Liaison

Discussions were held with the client to confirm the focus of the groundwater investigation and to gather available information for the desk study.

2.1.3 Desk Study

All available groundwater data were collected, collated and scrutinised. This included reports from previous work undertaken including the wells drilled in and around the area, well logs, test data, water quality data, monitoring data, climatic data, maps, stereo pair black and white air photography, etc. Government database data was also accessed for larger region around the Kingfisher site.

The desk study and data collection are the two essential components of any investigation. The information and findings of the desk study was integrated with the data and findings from the primary (field) data collection and analysis.

Several reports were provided by CNOOC as background information to the project. These included numerous standards, guidelines and existing and approved EIA's relevant to the project area. Table 2 lists the main reports, papers and documents; used as sources for this baseline investigation.

Table 2: Information sources - Reports

Author	Date	Title	Type
CNOOC	2014	Introduction to the Kingfisher field Geological Background	Presentation presented by Ronald Kaggwa to Golder 26/02/2014
CNOOC	2013	Kingfisher-4 Pre-Development Well ESIA	Presentation presented to Golder September 2013
CNOOC	2013	Injection water supply for the Kingfisher Development area	Internal Document
GAA	2013	Scoping report for the environmental and social impact assessment for Kingfisher discovery area in Hoima district, Uganda by CNOOC Uganda Ltd.	Report submitted to CNOOC December 2013
Environmental Assessment Consult Ltd	2013	The Environmental Audit for the drilling operations of Kingfisher 1, 2 and 3	March 2013
Environmental Assessment Consult Ltd	2013	EIA for 2D Seismic testing Kingfisher Area	June 2013
NEMA	2010	Environmental Sensitivity Atlas for the Albertine Graben	Report, 2nd Edition 2010
NEMA and PEPD	2013	Strategic environmental assessment (sea) of oil and gas activities in the Albertine graben, Uganda	Draft SEA Report





Author	Date	Title	Type
Heritage Oil	2006 to 2013	EIAs for drilling of Kingfisher KF1,2,3 and 4	Completed Drilling EIA's
Tobias Karp, Christopher A. Scholz, and Michael M. McGlue	2010	Structure and Stratigraphy of the Lake Albert Rift, East Africa: Observations from Seismic Reflection and Gravity Data	AAPG Memoir 95, p. 299 – 318
Total	2013	Proposed Appraisal Drilling: Mpyo Field (south area) Environmental and Social Impact Statement	Rev 0 – February 2013
Tullow Oil	2012	Report on the Environmental Baseline Exploration Area 2	Volumes 1, 2, and 3
Directorate of Water Development, Ministry of Water & Environment	2010	Hoima District Domestic Water Supply Report	Available at www.mwe.go.ug
Directorate of Water Resources Management, Ministry of Water & Environment	2012	Albert Water Zone, hydrogeological map series	PDF, with detail borehole data for Block 3A

The data set collected from the Directorate of Water Resources Management, Ministry of Water & Environment comprised of data for more than 200 boreholes drilled in the Block EA 3A and surrounding areas. The data was interpreted together with the Hydrogeological Map series produced in 2012 by the directorate.

The data set included information for:

- Coordinates;
- Depth to water strikes;
- Depth to bedrock;
- Well depth;
- Water level; and
- Lithological logs.

Actual data points in Block EA 3A was approximately 25 points (Figure 2). The several of these points were surveyed and investigated during the hydrocensus completed for the Kingfisher area (Figure 3).

Data was very limited in the south-western border of Lake Albert. It should be noted that groundwater data is limited to areas that is inhabited; the south western shore area of Lake Albert is mostly protected areas and very few communities reside in these areas, hence the scarcity of data.

This is however not seen as a limitation on the interpretation of the hydrogeological systems, since the regional geology is relative uniform – thus the hydrogeological properties from one area can be extrapolated to other areas. The majority of the aquifer systems exploited in the area is generally associated with the hard rock formations gneiss, granite and or quartzite – all of which are considered to be fractured type aquifers.



Hydrocensus

A hydrocensus was carried out to capture direct and updated information on existing groundwater points.

The main outcomes from the hydrocensus are as follows:

- Capture up to date water level data; and
- Capture up to date water quality data.

Data Processing and Evaluation

Data gathered during the desk study and hydrocensus were used to characterise the hydrogeological situation in the area. The interpretation and assessment of the available data identified information gaps. The impacts of these gaps in the context of the available information were quantified and pertinent recommendations were prepared and presented to the ESIA project team.

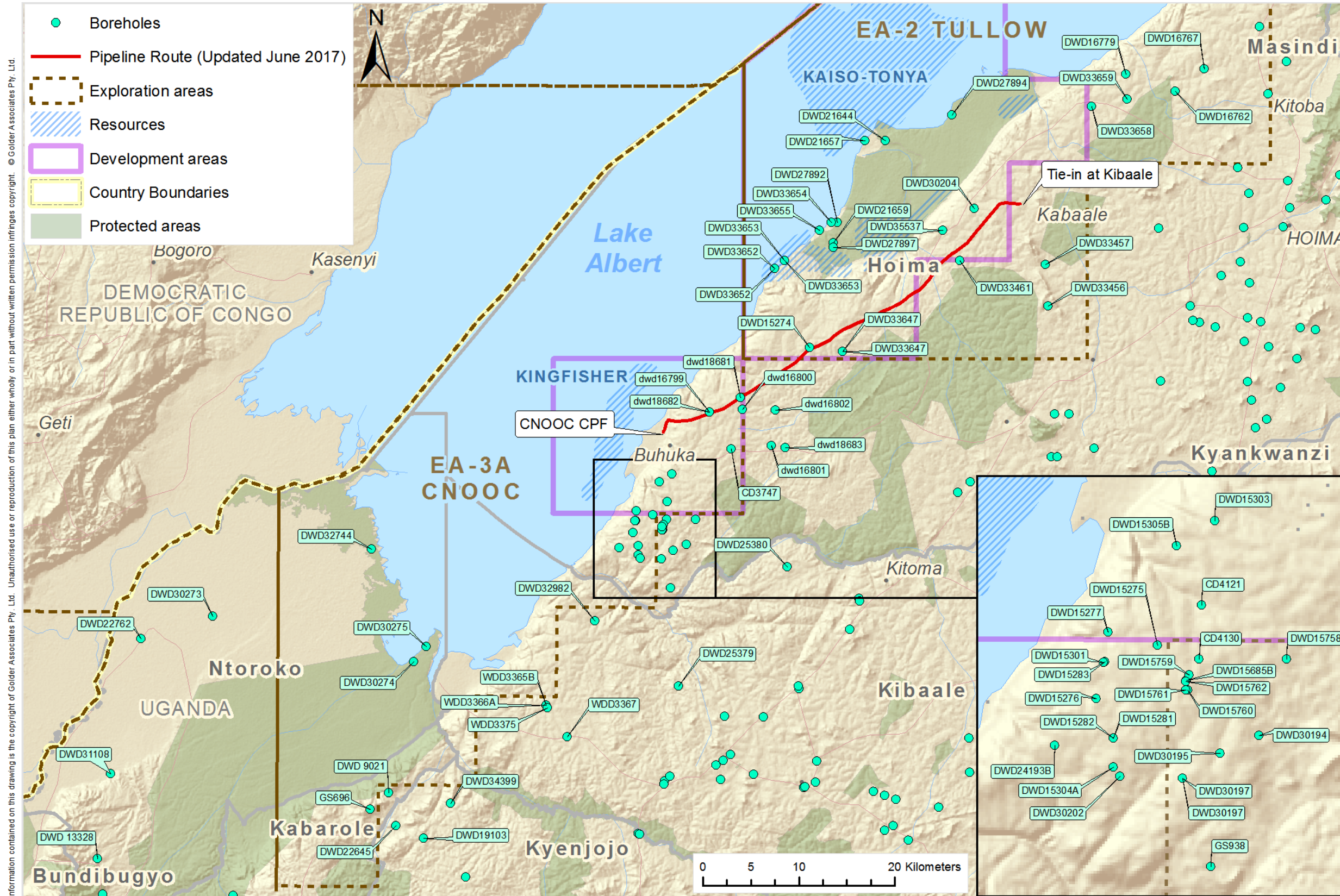

S:\GISS\GIS Projects\1776816 CNOOC\MXD\2017\Sep17\1776816 Block3A BH 20092017.mxd
 Figure 2: Distribution of data points – well/boreholes locations, Golder (2013) Groundwater Baseline Report for Kingfisher Block 3A





3.0 PROJECT SUMMARY

3.1 CPF, wells flowlines and associated infrastructure

The Kingfisher development is an upstream project comprising wells, flow lines, central processing facility (CPF) and associated infrastructure and an oil product line, the feeder pipeline, to distribute oil to the tie in point with the export pipeline at Kabaale. This infrastructure is summarised in more detail below.

The wells, flowlines, central processing facility (CPF) and supporting infrastructure are situated on the Buhuka Flats in the Kingfisher Development Area (KFDA), on the south-eastern shores of Lake Albert. The project entails the drilling of wells from four onshore well pads, namely Pad 1, Pad 2, and Pad 3 (where exploration wells have already been drilled) together with Pad 4A (where no drilling has yet taken place). A total of 31 wells are planned to be drilled and commissioned as part of the development, 20 of which will be production wells and 11 to be used as water reinjection wells.

The produced well fluids will be conveyed to the CPF through buried infield flow lines connecting each well pad to the CPF. Well fluids will be separated at the CPF to yield produced water, sand, salts and associated gas (together with small quantities of other material) and crude oil of a quality that will meet the crude oil export standard. At the CPF the associated gas will be utilised for production of power or LPG for local market. Power will serve the requirements of the Kingfisher development but in later years is likely to be in excess of project requirements and will be exported to the national grid. No gas flaring is contemplated except in cases of emergency.

Supporting infrastructure associated with the production facility will include in-field access roads and flowlines, a jetty, and a water abstraction station on Lake Albert, a permanent camp, a material yard (or 'supply base'), and a safety check station at the top of the escarpment. (Figure 4).

3.2 Feeder pipeline

A feeder pipeline exits from the CPF and extends to the north running from the CPF storage tanks to a delivery point near Kabaale. The feeder pipeline exits the CPF on the east side, running almost due north to the base of the escarpment, where the alignment turns to the East climbing the escarpment. The average gradient in this section of the route is 1:3 (Vertical: Horizontal), rising from roughly 650 to 1040 mamsl. within a horizontal distance of 740 m. From the point at which the feeder pipeline crests the escarpment, the pipeline route runs to the north-east through gently undulating terrain that is extensively cultivated. This landscape includes a number of rural settlements. The route passes south-east of Hohwa and Kaseeta villages and passes immediately north of the planned Kabaale Airport, turning eastward to the terminal point at the proposed Kabaale Refinery. The total length of the pipeline is 46.2 km.

At Kabaale, the Government of Uganda is planning an industrial park which, among other facilities, will include a refinery, associated petrochemical processing plants, an international airport and related supporting infrastructure.

At the delivery point, there will be metering of the crude oil, which will be piped either to the industrial park to feed the refinery and associated petrochemical industry or exported through the East African Crude Oil Pipeline (EACOP), planned from Kabaale to the Tanga sea port in Tanzania. The EACOP will be a public - private partnership between the governments of Uganda, Tanzania and oil company(s).

The Feeder Pipeline ends at the delivery point in Kabaale. The industrial park and the EACOP are independent projects that do not feature further in the FD-ESMP (Figure 5).

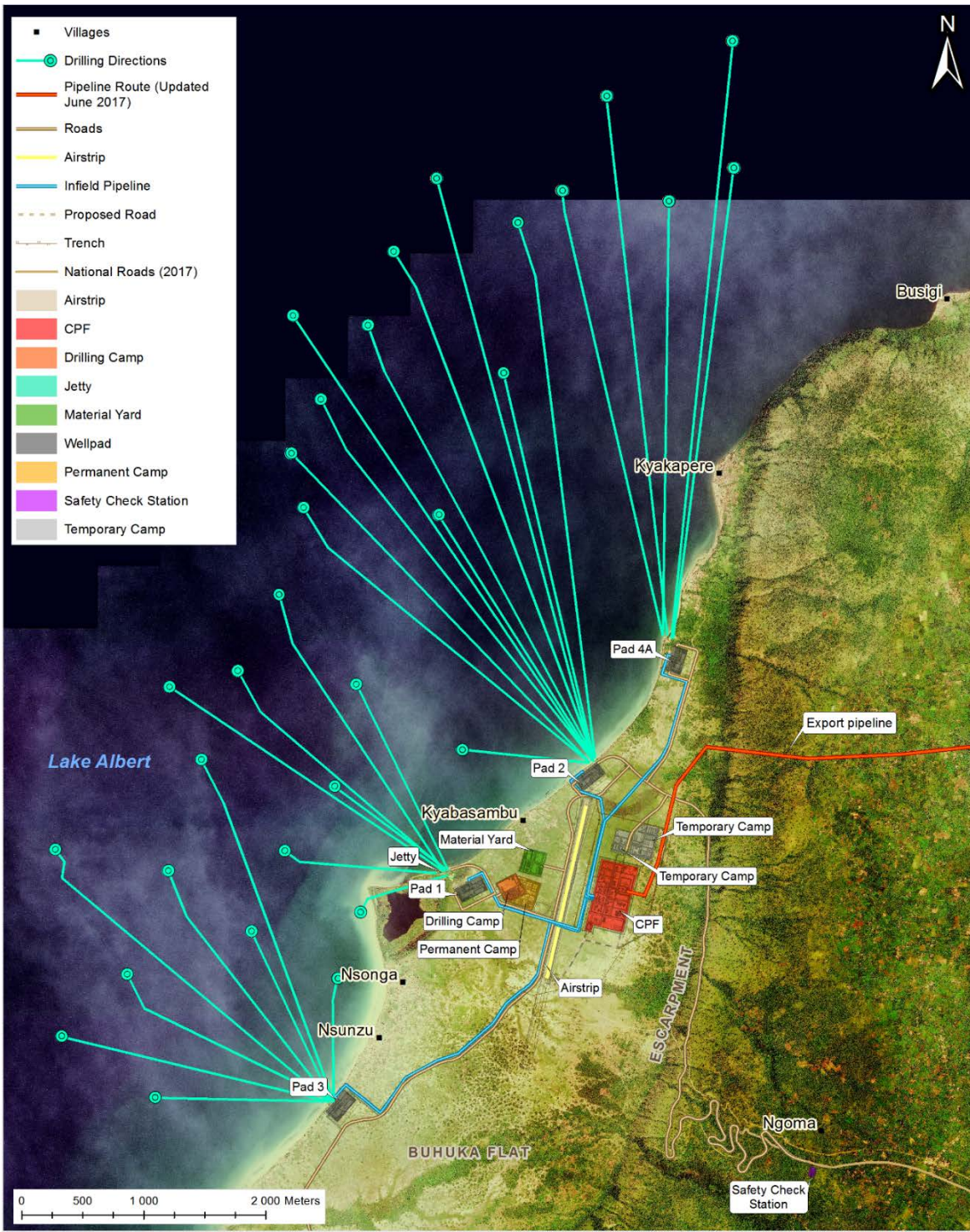

Figure 4: Infrastructure at Kingfisher Development Area

4.0 FIELD INVESTIGATIONS

Field investigations in this case were limited to a site familiarisation visit and two hydrocensus surveys for the project site. No other field investigations were performed.





The groundwater team carried out a hydrocensus to capture direct and updated information on existing groundwater points both down at the lake front and up on the escarpment.

The main outcomes from the hydrocensus are expected to be as follows:

- Capture of up to date water quality data; and
- Determination of the extent of groundwater use by local communities.

The hydrocensus was completed in two stages during December 2013 and March 2014. The first field trip involved the collection of groundwater, spring, stream, and lake water samples along the lake front of Lake Albert in the area directly affected by the Kingfisher project. During the March 2014 field trip, duplicate water samples were taken from the groundwater wells along the lake front to include petroleum hydrocarbon analyses for the establishment of a water quality baseline for these parameters. In addition, a hydrocensus was completed along the pipeline route and through all communities that could potentially be affected by the activities and groundwater samples were taken from wells.

A total of 14 samples were taken at the lake front, and another 15 were taken on the escarpment along the pipeline route. Water level measurements were limited to two unused wells near the camp site. A summary of the information collected is provided in Table 3 and the locations of surveyed points are shown on Figure 3.

Microbial sampling was undertaken in June 2014 from the hydrocensus sampling points. Personal communication and observations made in the villages clearly indicate that faecal contamination of water sources is typically due to poor sanitation practiced in the area. From the hydrocensus, the general practices regarding groundwater use and water quality distribution has been established for the areas directly affected by the project activities.

Limitations to the data collections that should be noted were:

- The major information gap identified from the field data is the lack of water level data. The community wells are all sealed with hand pump head gear, and there is no access to measure water levels. Water level measurements were limited to two wells in the villages Kyabasambu and Kisonga on the flats. Both wells had handpumps that were no longer working, and the headgear was physically removed to take samples and measure the water level depth. Therefore, no piezometric groundwater maps can be produced to infer the general groundwater flow direction and/or gradient from field data;
- On the flats there are no functioning wells left with the exception of one at Kina, where the water is too saline for potable use. The main water sources are the gravity flow, non-perennial streams, and the lake;
- The first round of samples were analysed for inorganic parameters only, and the second round of samples included organic hydrocarbon analyses; and
- Microbial analyses could not be done at a laboratory due to the short time period that is required (less than 24hours) between sampling and analysis. Colitag™ test kits were used for the microbial analyses of the hydrocensus points. Colitag™ is a Presence/Absence and MPN enzyme substrate test that detects as few as 1 MPN of total coliform and *E. coli* bacteria per 100mL water sample. Results can be read any time between 16 and 48 hours. Colitag™ is US EPA approved for use as a presence absence test and in the Most Probable Number (MPN) format as specified in Standard Method 9221 for compliance monitoring of total coliforms and *E. coli* in drinking water.



Table 3: Hydrocensus summary

Date	Site name	Type	Water level (mbgl)	Sample y/n	Depth in metres	Community comments
12/12/2013	Nsonga	No well		n		Gravity flow scheme, Pipes are corroded pump not working
12/12/2013	Nsunza	Gravity flow scheme		n		Gravity flow scheme, Pipes are corroded pump not working
12/12/2013	Ususa (BH)	Deep well		y		3.5 pipes, close to lake
12/12/2013	Ususa (Spring)	Spring		y		Source where rock face cuts the sediments on escarpment
12/12/2013	Kyenyanja	Deep well		y		One working well, and spring/stream
13/12/2013	Kyakapere	Gravity flow scheme		n		No working wells, Gravity flow/lake water
13/12/2013	Senjonjo (spring/stream)	Stream		n		No wells, villagers complain WQ is affected by upstream village on escarpment
13/12/2013	Kacunde	Deep well		y		Wells, but use gravity flow or lake
13/12/2013	Kina	Deep well		y		Saline as observed from ground surface and comments from villagers
13/12/2013	Busigi	Deep well		y		Well and stream
13/12/2013	Kyabasambu stream			n		One of the sources of the Buhuka flat
13/12/2013	Lake Albert			n		Lake sample
01/02/2014	Kyangwalisubcounty HQ	Deep well		y		Refugee camp
28/02/2014	Kyabasambu (CPF1)	Deep well	5.3	y		Pump broken - removed headgear to measure water level
28/02/2014	Kisonga (CPF2)	Deep well	6.66	y		Pump broken - removed headgear to measure water level
28/02/2014	Ususa	Motor drilled shallow well		y		





Date	Site name	Type	Water level (mbgl)	Sample y/n	Depth in metres	Community comments
28/02/2014	Kyenyanya	Motor drilled shallow well		y		
28/02/2014	Gravity flow scheme	Gravity flow scheme		n		
28/02/2014	Kiina	Deep well		y		Saline as observed from ground surface and comments from villagers
02/03/2014	Kabale1	Deep well		y	39	Saline water
02/03/2014	Kabale2	Protected dug well		y		
02/03/2014	Kabale3	Protected dug well		y	4.5	
02/03/2014	Kisoba 1	Protected dug well		y	4.5	
02/03/2014	Kisoba 2	Protected dug well		y	3	Dries up with continues pumping
02/03/2014	Kisoba 3	Deep well		y	42	High population
02/03/2014	Hohwa 1	Protected dug well		y	3	Seasonal well
03/03/2014	Kabegaramire 1	Deep well		y	33	
03/03/2014	Kyarushesha	Protected dug well		y		Broken down
03/03/2014	Kasoga 1	Deep well		y	27	Bad smell
03/03/2014	Kasoga 2	Protected dug well		y	3	
03/03/2014	Kyarujumba	Deep well		y	33	
03/03/2014	Hanga 2B	Deep well		y	24	
03/03/2014	Hanga 2A	Deep well		y		

A follow up survey of villages where boreholes or hand dug wells are used for water supply was undertaken during May and June 2015. The aim of this survey was to ground truth the government data collected, and fill information gaps. The villages to the south of Lake Albert were visited and groundwater abstraction points were recorded where possible. More than 30 villages were visited with details of wells recorded for 24 wells; of which 10 were sampled (Figure 5).

The Government database data set was used as a reference point, however several of the sites from the database could not be found; were destroyed or not in working condition.



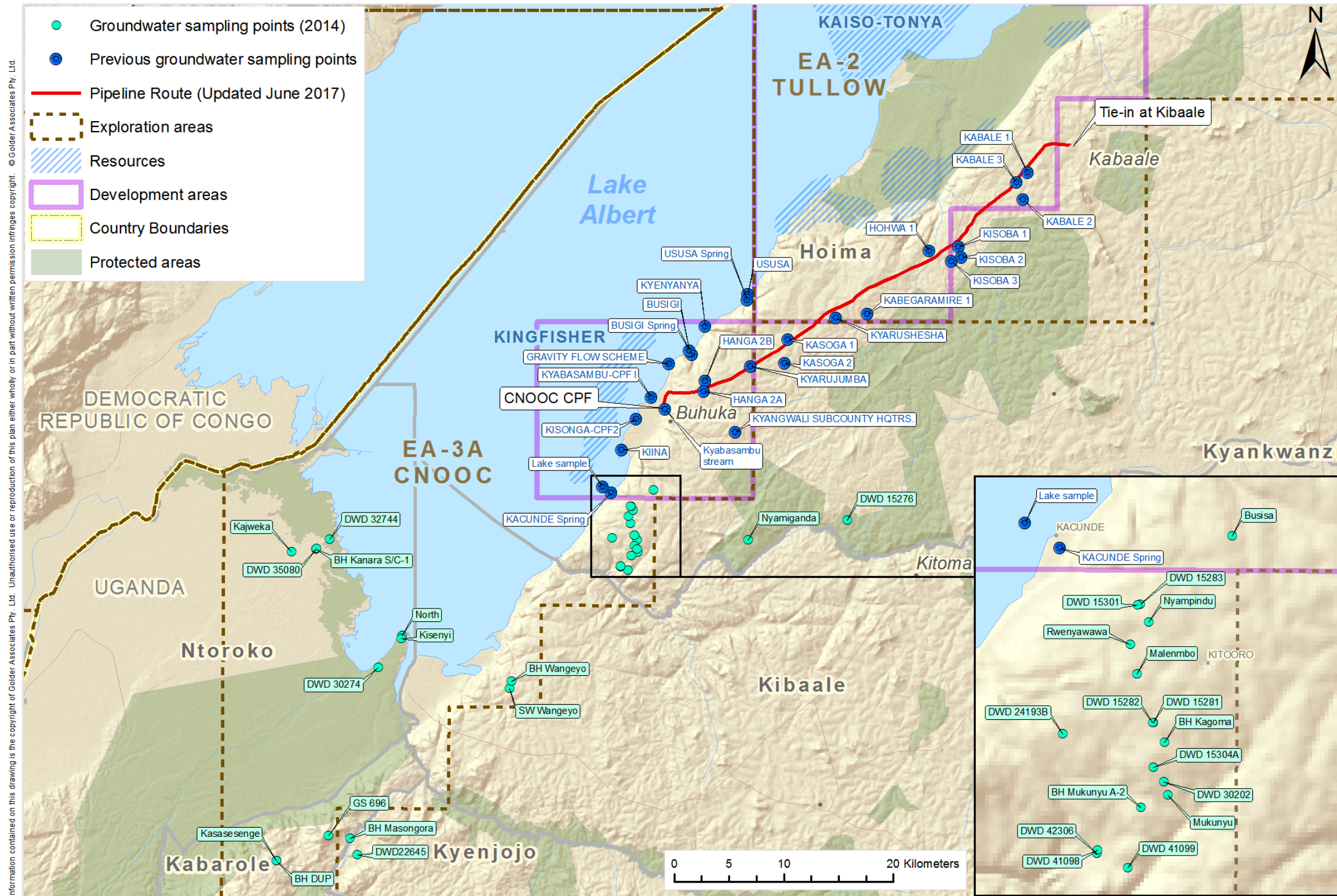

S:\GSI\GIS Projects\1776816 CNOOC\MXD\2017\Sep17\1776816 Block3A GWSampling2014 21092017.mxd

Figure 5: Follow up survey of wells in villages, indicated on the original baseline map backdrop to indicate clearly which boreholes were revisited





GROUNDWATER SPECIALIST STUDY

Table 4: Follow up field survey results

Date	ID	Coordinate 36N		Village	Remark
		N	E		
02/06/2015	BH Mukunyu	0247762	0124391	Mukunyu	Sampled
02/06/2015	BH Nyamiganda	0257815	0125558	Nyamiganda	Sampled
02/06/2015	BH Malenbo	0247084	0127078	Malenbo	Sampled
02/06/2015	BH Rwenyawawa	0246944	0127728	Rwenyawawa	Sampled
02/06/2015	BH Nyampindu	0247354	0128225	Nyampindu	Sampled
02/06/2015	BH Busisa	0249187	0130129	Busisa	Sampled
03/06/2015	BH Kasasesenge	0214793	0096310	Kasasesenge	Sampled
04/06/2015	BH Kajweka	0216159	0124471	Kajweka	Sampled
04/06/2015	BH Ntoroko North	0226248	0116790	Ntoroko North	Correspond with government number DWD 30275; sampled
04/06/2015	BH Kisenyi	0226164	0116579	Kisenyi	Sampled
28/05/2015	DWD 30274	0224076	0113932		Not in working condition
29/05/2015	BH Kanara S/C-1	0218395	0124718		Not in working condition
29/05/2015	DWD 35080	0218449	0124766		Not in working condition
30/05/2015	BH Masongora	0221470	0098349	Masongora	Not in working condition, in Village Masongora
30/05/2015	DWD22645	0222154	0096811	Byeya	Working condition; installed Apr-2006, out of Block 3A
31/05/2015	SW Wangeyo	0236094	0111991	Wangeyo	Working condition; installed Apr-13, depth 7m, pump installation depth 1.8m,funded by Land Rover and IFRC
31/05/2015	BH Wangeyo	0236229	0112672	Wangeyo	Working condition; installed Mar-13, BH depth 81.57m, pump installation depth 21m, funded by Land Rover and IFRC
02/06/2015	BH Kagoma	0247692	0125562	Kagoma	Working condition; installed Mar-13, funded by The Church of Jesus Christ of Latter-day Saints"
02/06/2015	BH Mukunyu A-2	0247166	0124124	Mukunyu	Working condition; installed Jan-15
02/06/2015	DWD 41099	0246879	0122785	Mukunyu	Working condition; funded by UHCR.
02/06/2015	DWD 42306	0246198	0123110	Mukunyu	Working condition; funded by UNICER
02/06/2015	DWD 41098	0246213	0123173	Mukunyu	Working condition; funded by UNHCR





5.0 BASELINE ENVIRONMENT

5.1 Climate

5.1.1 Rainfall

The Albertine Graben has sharp variations in rainfall amounts, mainly due to variations in the landscape. The landscape ranges from the low lying Rift Valley floor to the rift escarpment and the raised mountain ranges. The Rift Valley floor lies in a rain shadow of both the escarpment and mountains, and has the least amount of rainfall; averaging less than 875mm per annum (much lower than that of the highland area).

Rainfall records by Directorate of Water Resources Management (NEMA, 2013) indicate that Moyo in the extreme north-east received an annual rainfall mean of 1174.8mm over a seven year period (between 2003 and 2009). During this period the highest annual mean rainfall was in 2006 (1593.9mm) while the lowest was in 2004 (623.6mm) indicating a high range in the mean annual rainfall received. Butiaba around Lake Albert in the centre north-east receives 750mm, while Kasese in the central part of the Graben receives a slightly higher mean rainfall of 970mm. On the highland areas of the rift escarpment, rainfall averages increase largely due to orographic influences. For example, Masindi receives an annual average rainfall of 1359mm, while Hoima receives 1435mm (NEMA, 2013).

5.1.2 Temperature and humidity

The Albertine Graben region lies astride the equator. The region experiences small annual variations in air temperatures; and the climate is generally hot and humid, with average monthly temperatures varying between 27°C and 31°C. Maximum temperatures are consistently above 30°C and sometimes reach 38°C. Average minimum temperatures are relatively consistent and vary between 16°C and 18°C. High air temperatures result in high evaporation rates causing some areas to have a negative hydrological balance.

The relative humidity in the Albertine Graben is higher during rain seasons with maximum levels prevalent in May. The lowest humidity levels occur in dry seasons with minimum levels occurring in December and January. The average monthly humidity is between 60% and 80% (NEMA, 2013).

5.1.3 Wind

Wind speed and direction records indicate a high incidence of strong winds especially in the Rift Valley (NEMA, 2013). The prevailing winds commonly blow along the valley floor in a north-east to south-west direction or vice versa. Winds also blow across the Rift Valley in an east to west direction. On the escarpment and mountain slopes, prevailing wind-directions are typically multi-directional. Overall, the area typically experiences moderate to strong and gusty winds, increasing in the afternoon. Both wind speed and direction have important implications on oil exploration and production activities particularly the dispersion potential for oil pollutants (NEMA, 2013).

5.2 Topography and Drainage

Lake Albert occupies the northernmost rift basin in the western rift valley. The lake is approximately 130km long and approximately 35km wide and is an open hydrologic system that receives its major input from the Semliki River to the southwest and the Victoria Nile to the northeast. Lake Albert is relatively shallow as most other large East African rift lakes, found to the south, have maximum water depths of approximately 58m.

Within the Albertine Graben, there are three main lakes: Lake Albert, Lake Edward, and Lake George. Most of the rivers and streams originating from the highlands surrounding this area drain into the lakes which, in turn, drain into the Nile via Lake Albert. Most significant of these rivers is River Semliki which comes from Lake Edward through the western edge of the great Ituri rain forest in DR Congo, and enters Uganda at a point close to the northern end of the Rwenzori range. The other is the Victoria Nile which enters Lake Albert at its northern most tip before draining out of the lake as the Albert Nile on its way to Nimule and onward to Sudan. Both rivers have built deltas into Lake Albert; Semliki being the largest. Ninety percent of the delta is created in Uganda. Although the Victoria Nile carries more water than the Semliki, it has little influence on the ecology of the lake, other than to maintain water levels. The Semliki on the other hand provides the primary supply of water into the lake system. The lake also has a large sedimentation potential from the



Victoria Nile. There are other numerous small streams entering the lake from both Uganda and DR Congo, some of which are highly seasonal and of only minor importance to the hydrology of the lake.

A series of erosion valleys and gullies cut the escarpment and discharge runoff from the escarpment to the valley. There are also seasonal streams and rivers which are flooded by runoff from the catchment areas after heavy rainfall events. In the Lake Albert area, water from these rivers drains quickly; either into Lake Albert or it seeps into the thick sediments of the Rift Valley floor. The seasonal rivers in this area include Sebugoro, Kabyosi, Warwire, and Nyamasoga.

Most of the rivers and streams have incised into the landscapes leading to a topographic pattern of narrow river valleys and sometimes gorge-like features. Due to the nature of rift escarpment landscape, the rivers and streams flowing into the Rift Valley often have a limited catchment size and this implies limited hydrological potential. Consequently, some of the scarps are drained by ephemeral (intermittent) flows to the extent that some of the river valleys are dry most of the time.

5.3 Geology

5.3.1 Regional Geology

The Albertine Graben is a 500 km-long rift basin of Mesozoic-Cenozoic origin that straddles the border of Uganda and the Democratic Republic of Congo. It is developed upon the Precambrian orogenic belts of the African Craton and is bordered by steep normal faults with uplifted flanks composed of Precambrian basement rocks such as gneisses, quartzites and matie intrusions (Byakagaba, 2004).

The geological sequence in the Albert Basin is of Miocene – Recent age, resting on metamorphosed pre-Cambrian basement. The oldest sediments so far encountered have been of Late Miocene age. It is thought that approximately 6,000m of section were deposited in the central part of the basin, with some 3,000m present in the area of Kingfisher Field. The sequence comprises a series of interbedded sandstones and shales, representing a mixture of low-stand events, during which sedimentation was dominated by fluvial processes and flood or high-stand events when lacustrine deposition predominated.

The high petroleum potential of the basin is due to the thickness (>5000m) of organic-rich sediments and the well-developed reservoir rocks which contain porous and permeable sands and conglomerates. There is a very high quartz content within the reservoir rocks (>75%) which makes them resistant to compaction and therefore contributes to the preservation of the porosity. It is also thought that the fractured and weathered basement may also act as a reservoir. Rifting within the basin caused the formation of several large-scale structural traps, whereas facies change, and unconformities lead to the development of stratigraphical and lithological traps.

Observations from seismic-reflection and gravity data sets reveal that the overall structural morphology of Lake Albert is that of a full Graben, which is a unique configuration in the western rift valley. The Bunia border fault bounds the entire basin along the western shore, and it is opposed on the eastern margin by a complex of several large basement involved faults, which created two structural sub-basins. Major basement-involved faults control the modern distributions of isobaths and the location of deep-water areas. The maximum thickness of the sedimentary section is 5km and dip on pre-rift basement is shallow (<18degrees) (Karp, et.al. 2010).

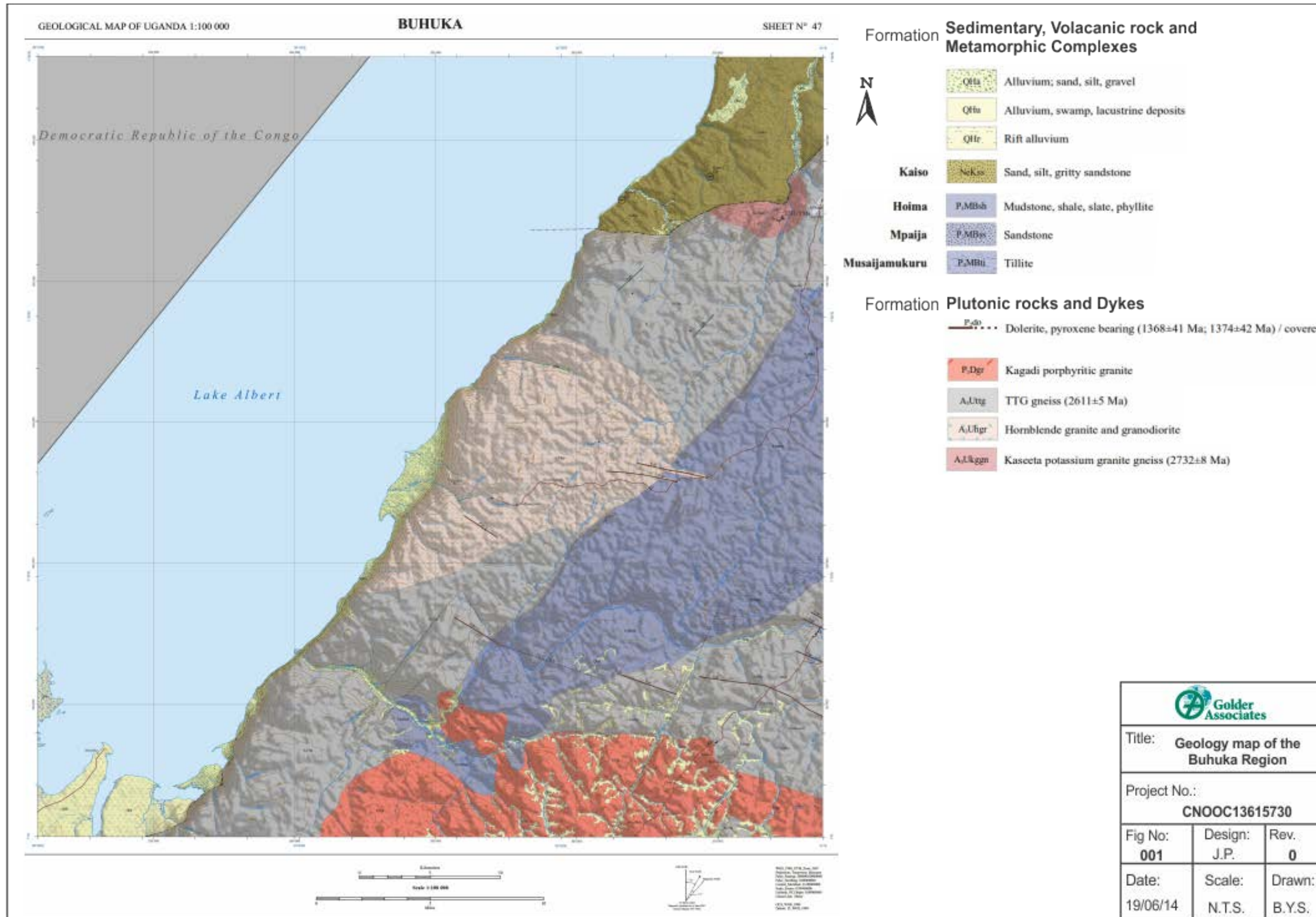

Figure 6: Regional Geological Map (adapted from Geological maps produced by Department of Geological Survey and Mines, 2012)



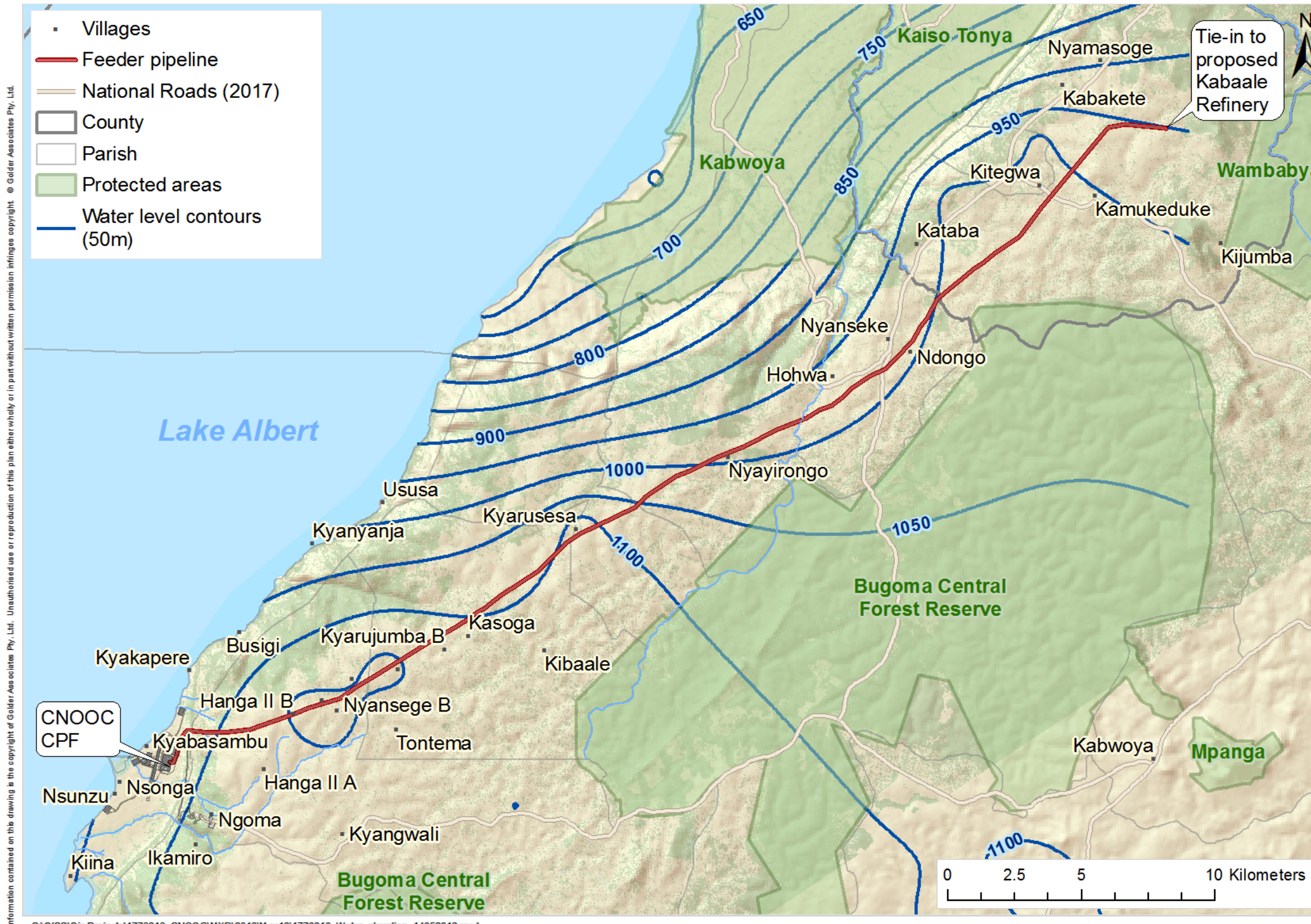

Figure 7: Water elevation map for the Kingfisher Project area





5.3.2 Local Geology

The Kingfisher field is formed by a structural trap, which comprises a southwest-northeast trending 3-way dip-closed hanging-wall anticline that seals against basement to the south-east along the main bounding fault of the Albert Basin. The field is about 10km by 2km and provided the drilling sites for 3 wells and 3 side-tracks (CNOOC, 2014).

The sedimentary succession of Kingfisher is composed of intervals of Late Miocene and Pliocene age. The Late Miocene and Pliocene intervals can be subdivided into M5 and M6 unit of Late Miocene, P1 and P2 units of Early Pliocene, P3 and P4 units of Late Pliocene (See Figure 8).

Pick Name	Age	Kingfisher-1	Kingfisher-1A	Kingfisher-2	Kingfisher-3	Kingfisher-3A
P4	Late Pliocene	972.00m MD	973.00m MD 972.70m TVD	1018.00m MD 966.39m TVD	1027.00m MD 960.50m TVD	1021.00m MD 960.83m TVD
P3	Late Pliocene	1152.00m MD	1153.00m MD 1152.14m TVD	1296.00m MD 1171.73m TVD	1310.00m MD 1174.75m TVD	1259.00m MD 1163.11m TVD
P2	Early Pliocene	1407.00m MD	1435.00m MD 1418.80m TVD	1702.00m MD 1473.49m TVD	1807.00m MD 1546.68m TVD	1689.00m MD 1541.34m TVD
P1	Early Pliocene	1807.00m MD	1880.00m MD 1827.93m TVD	2257.00m MD 1890.82m TVD	2330.00m MD 1938.76m TVD	2065.00m MD 1876.34m TVD
M6	Late Miocene	Not present	2376.31m MD 2298.27m TVD	2800.74m MD 2306.58m TVD	2947.42m MD 2424.23m TVD	2546.38m MD 2347.65m TVD
M5	Late Miocene	Not present	2533.00m MD 2443.86m TVD	3012.00m MD 2468.34m TVD	3145.00m MD 2575.28m TVD	2676.00m MD 2476.64m TVD
Basement	Pre-Mesozoic	2066.00m MD	2830.00m MD 2719.84m TVD	3601.00m MD 2928.88m TVD	Not reached	Not reached
TD		2125.00m MD 2121.35m TVD	2962.40m MD 2847.40m TVD	3906.00m MD 3198.00m TVD	3200.00m MD 2619.19m TVD	2712.00m MD 2512.19m TVD

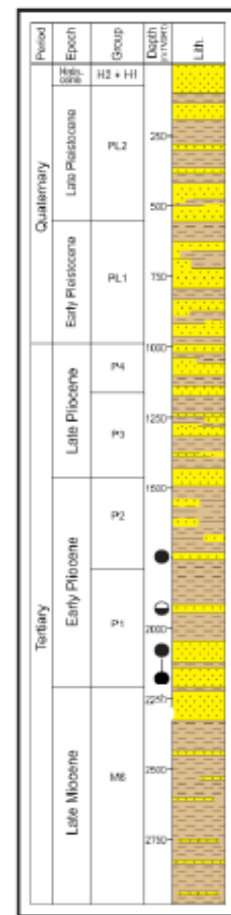

Figure 8: Sedimentary Sucession at Kingfisher (CNOOC, 2014)

The initial Kingfisher- well intersected a hydrocarbon-bearing interval from 1,783 - 1,795m MD (maximum depth). This upper interval has been termed “Zone 1”. The well subsequently intersected basement at 2,095m, significantly shallower than anticipated and was side-tracked to the northwest as Kingfisher-A. This encountered the Zone 1 sandstone interval about 250m from the original discovery location but found it to be water-wet, thereby showing the hydrocarbon reserve at this level to be very small. The Kingfisher-A side track subsequently discovered a lower hydrocarbon bearing interval from 2,259.5m to 2,372.5m which was denoted as “Zone 2”. The second side-track, Kingfisher-B, did not encounter any hydrocarbons at deeper levels. Subsequent appraisal drilling on the Kingfisher structure comprised wells Kingfisher-2, -3 and -3A, also deviated to the northwest. These focused exclusively on the Zone 2 reservoirs.

Preliminary results from the geotechnical drilling showed that Pad-2 is underlain by inorganic clays up to an average depth of 18m followed by a mixture of silty sandy clays to 30m.





5.4 Hydrogeology

5.4.1 Regional Hydrogeology

Data reviewed at the Directorate of Water Development (DWD, 2014) indicate that data for groundwater wells in the Kingfisher areas are limited to areas of inhabitation. The following is inferred from the data reviewed and the published hydrogeological maps for the region:

- The Hoima district area is covered by the basement rocks, with the main geological units in the basement are laterites, granites, clays and gneisses. Fractured granitic rocks form the main unit are considered to be a sustainable aquifer system.
- Analysed borehole lithology logs for Hoima district revealed that the basement had two water bearing zones; the weathered and fractured-rock zones.
- Wells are drilled to depths of between 23m and 152m, with the average being around 62m below ground level;
- The bedrock depths were provide to be on average 30m below surface, and were recorded to be either of from granitic and quartzitic origin. The upper lithologies are mainly described as interbedded clay and/or sand sediments of various thicknesses;
- The water strikes are mainly associated with fractured and weathered bedrock and it can therefore be concluded that the aquifer systems utilised will have a fractured character. Recorded yields varied between very low (0.1l/s) to high (20 l/s), with the average at 2.9l/s. 25% of boreholes recorded had yields higher than 4l/s. The variability in yields is typical of fractured bedrock type aquifers; and
- Water level data for the lake front villages showed that the water levels occurred between 5.37- 6.37m (this includes water levels measured during the hydrocensus) below surface. On the escarpment water levels were on average 18.1m below surface. 40% of the recorded water levels on the escarpment were deeper than 20m below surface. General groundwater flow direction in the KP area is towards Lake Albert in a north-westerly direction (Figure 7).

5.4.2 Site Hydrogeology

From the hydrocensus results it was seen that only 5 out of the 10 villages visited along the lake front had functioning wells from which potable water could be sourced. Wells are prone to fail due to corrosive properties of the groundwater (i.e. often the pipes are corroded away, if not maintained). The villagers conveyed that wells often do not yield enough water or that water quality is too poor for use. As an alternative, villagers augment their water supply with lake water and/or springs or streams against the escarpment.

As discussed earlier, measuring water levels in the wells was difficult due to the type of pump installations typical for the area, Figure 9.



Figure 9: Typical well installation in the Kingfisher project area

Field parameters measured during the hydrocensus along the lake front villages are shown in Table 5 . The wells at Busigi and Kiina were found to have high salinity and villagers therefore do not want to use the water.

Table 5: Field parameters measured at wells and springs along the lake front (2014)

Village	pH	EC ($\mu\text{S/m}$)	Redox (mV)	T $^{\circ}\text{C}$
Senjonjo (s)	7.34	1160	-55	24.1
Kacunde (s)	7.97	790	62	23.7
Kiina (w)	8.09	>2000	0	28.6
Busigi (w)	8.79	2970	106	28.4
Busigi (s)	8.93	893	83	25.8
Ususa (w)	9.34	256	50	28.2

s – spring or stream

w - well

It was observed that during the rainy season, the groundwater level in the Kingfisher area is less than 1mbgl in certain areas. These perched water table conditions are likely caused by the poorly-porous and slow draining clayey soils. Accordingly, it is probable that a limited perched aquifer beneath the site may be accessible as a water source through shallow hand dug wells. This source is however relatively unprotected from surface infiltration of contaminants and not reliable throughout the year. It is inferred that shallow groundwater in the area flows in a generally westerly direction towards the lake.

The hydrogeology along the pipeline route differed from that observed at the flats and lake front villages. Fifteen wells were recorded at the villages along the pipeline route (Table 3). These wells are the main source of water for the people living along the route. A small percentage of the wells recorded were shallow (<5mbgl) dug wells with hand pumps installed. However, users complained about poor quality of water and



seasonality of the shallow wells. The deeper wells were found to be generally reliable source of water with occasional complaints regarding water quality.

During the follow up survey in 2015 water quality samples were taken south along the lake front and along the escarpment of the Kingfisher Project area and pipeline (Figure 5). Eleven of the wells surveyed were sampled and field water quality parameters were measured and recorded (Table 6). As with the previous hydrocensus all the functioning wells are equipped with hand pumps and no water level data could be recorded. Some of the installed wells did have date of installation and depth of installation recorded on the head gear which was noted. Two wells where installation depth was recorded also varied between 7m and 81m below ground surface. Once again, the variable water quality and water levels indicated that the aquifers utilised by local communities are highly heterogeneous.

Table 6: Field chemical parameters recorded for samples along the pipeline route (2015)

ID	DO mg/L	T °C	EC us/cm	pH
* BH Mukunyu	2.95	25.4	370	7.9
* BH Nyamiganda	3.63	23.8	240	7.6
* BH Malenmbo	2.89	24.3	2.8	7.1
* BH Rwenyawawa	3.88	25.2	25.2	6.8
* BH Nyampindu	4	24.3	470	7.6
* BH Busisa	4.6	24.4	330	7.5
* BH Kasasesenge	6.11	23.9	136	8.3
* BH DUP (1)	6.11	23.9	136	8.3
* BH Kajweka	4.87	27.5	1600	8.1
* BH Ntoroko North	3.11	24.3	690	7.5
* BH Kisenyi	4.75	28.5	510	7.4

It can generally be inferred that the bedrock aquifer associated with the granite, gneiss, and quartzite formation can be utilised as a sustainable and reliable water source. The aquifer is characterised as a fractured rock aquifer and yield is generally dependant on structural properties of the formation. The heterogeneity is observed in the variable water level elevation observed of the system

The aquifer can be classified as moderately vulnerable due to the relative depth (~20mbgl) of water table and is the main source of potable water of villages in the study area. The exception is on the Buhuka flat where the water quality is poor and water properties corrosive to infrastructure. Shallow perched aquifers associated with weathered sediments are often utilised as a source of water but vulnerable to contamination and not sustainable throughout the drier months of the year.

5.4.3 Groundwater Quality

From the discussion above it is clear that there are water quality issues related to the groundwater sources within the study area. Samples were taken from various wells, springs, streams and the lake to determine the water quality baseline for the area. Historical or monitoring water quality data is very limited for the study area. For instance, some of the previous ESIs for the oil field development have limited once off sample results and it is not always clear where the samples were taken and from what type of water source (RPS, 2006; AWE, 2008 and 2013; AECOM, 2012) .

The samples submitted for chemical analyses were analysed at either National Water Quality Reference Laboratory in Entebbe, Uganda or at Jones Environmental Laboratory in the UK. All results were compared to the Uganda National Bureau of Standards (UNBS) standard **US 201 (2008) for Drinking (potable) water** (2nd Edition). Only parameters that tested above detection limits are included in this discussion and full results are provided in APPENDIX A.



From the discussion above it is clear that there are water quality issues related to the groundwater sources within the Kingfisher Development Area and along the proposed pipeline route. Similar to the hydrogeological properties the water quality results can also be extrapolated from the KDA area to Block EA 3A.

Samples were taken from various wells, springs, streams and the Lake to determine the water quality baseline for the area. Historical or monitoring water quality data is very limited for the study area. Some of the previous ESIA's for the oil field development, has limited once off sample results, it is not always clear where the samples were taken and from what type of water source.

The samples submitted for chemical analyses were analysed at either National Water Quality Reference Laboratory in Entebbe, Uganda or at Jones Environmental Laboratory in the UK.

All results were compared to the Uganda National Bureau of Standards (UNBS) standard **US 201 (2008) for Drinking (potable) water** (2nd Edition).

5.4.3.1 Physical Parameters

The Physical parameters include: Electrical Conductivity (EC), pH, Total Dissolved Solids (TDS), Total suspended solids (TSS), Turbidity, Total Hardness, and Total Alkalinity, **Table 7**.

Generally, physical parameters are all well below the required standards, with the exception of pH and salinity along the lake front wells and surface water points. pH of surface water and groundwater sources along the lake front tend towards alkaline (pH values above 9). Kyangwali's borehole sampled at the escarpment had a pH of 5.99, the only site with a slightly acidic pH, this is typical of granitic type groundwater. Other sampled sites were well within the acceptable standards for pH. Boreholes on the Buhuka flats (Kina and Kyabasambu) were characterised with very high salinity (EC > 3800 mS/m). Hardness and alkalinity for all sites are well within acceptable standards, except for Kina and Kyabasambu samples that have hardness in excess of a 1000 mg/L.

Based on the physical parameters it can be concluded that groundwater (and surface water) at the lakefront are not recommended for domestic use due to excessive salinity, hardness and elevated pH. The groundwater tested on the escarpment at community boreholes can generally be described as good quality water based on these parameters and suitable for domestic use.



Table 7: Physical parameters for the sites sampled (mg/L unless otherwise stated)

Site Name	Date	EC (mS/m)	pH	TDS	TSS	Turbidity (NTU)	Total Hardness Dissolved (CaCO ₃)	Total Alkalinity
US 201 drinking potable water specification Class 2		250	6.5-8.5	1200	-	10	-	500
WHO drinking water (2011)		-	Not of health concern at levels found in drinking-water	Not of health concern at levels found in drinking-water	-	-	Not of health concern at levels found in drinking-water	-
Kyabasambu stream	10/12/2013	35.1	10.00	284	1	1	-	76
Busigi stream	10/12/2013	54.3	10.10	335	3	1	-	80
Ususa spring	10/12/2013	66.7	9.30	197.5	4	2	-	76
Senjojo stream	10/02/2014	29.3	9.68	373.8	3	2	-	36
Kachunde stream	10/02/2014	44	9.95	249	2	1	-	80
Kina shores	10/12/2013	63.4	10.10	326	0	0	-	84
Lake Albert	10/02/2014	57.6	9.96	390.4	0	1	-	48
Nsonga shorelines	10/02/2014	58.9	10.03	387.8	9	6	-	88
Ususa BH (shallow well)	06/03/2014	97.9	7.23	903	-	-	246	222
Ususa BH (shallow well)	10/02/2014	85	9.38	470	5	2	-	36
Kina BH	10/12/2013	4400	7.75	20100	24	1	-	48





GROUNDWATER SPECIALIST STUDY

Site Name	Date	EC (mS/m)	pH	TDS	TSS	Turbidity (NTU)	Total Hardness Dissolved (CaCO ₃)	Total Alkalinity
US 201 drinking potable water specification Class 2		250	6.5-8.5	1200	-	10	-	500
WHO drinking water (2011)		-	Not of health concern at levels found in drinking-water	Not of health concern at levels found in drinking-water	-	-	Not of health concern at levels found in drinking-water	-
Kina BH	06/03/2014	3826.7	6.89	4477	-	-	7952	258
Kyenyanya BH	10/12/2013	67.1	10.10	906	0	1	-	88
Busigi BH	10/12/2013	176.6	10.20	307	0	1	-	100
Kyenyanya BH	06/03/2014	82	8.00	916	-	-	172	290
Kyabasambu (CPF1)	06/03/2014	719.3	7.13	4776	-	-	1362	304
KYANGWALI HQ	06/03/2014	19.9	5.99	1406	-	-	73	56
KABALE 1	02/03/2014	44.4	6.74	312	-	-	164	198
KABALE 2	02/03/2014	23.3	6.60	237	-	-	55	114
KABALE 3	02/03/2014	43.3	6.99	284	-	-	169	218
KISOBA 1	02/03/2014	29.8	6.83	236	-	-	102	146
KISOBA 2	02/03/2014	44.8	7.07	301	-	-	183	206
KISOBA 3	02/03/2014	24.7	6.64	183	-	-	97	118





GROUNDWATER SPECIALIST STUDY

Site Name	Date	EC (mS/m)	pH	TDS	TSS	Turbidity (NTU)	Total Hardness Dissolved (CaCO ₃)	Total Alkalinity
US 201 drinking potable water specification Class 2		250	6.5-8.5	1200	-	10	-	500
WHO drinking water (2011)		-	Not of health concern at levels found in drinking-water	Not of health concern at levels found in drinking-water	-	-	Not of health concern at levels found in drinking-water	-
HOHWA 1	02/03/2014	64.3	7.53	554	-	-	244	336
KABEGARAIRE 1	02/03/2014	39.1	7.13	292	-	-	178	186
KYARUSHESHA 1	02/03/2014	27.7	6.96	222	-	-	85	100
KASOGA 1	02/03/2014	47.5	7.36	341	-	-	227	252
KASOGA 2	07/03/2014	17.4	6.57	150	-	-	57	90
KYARUJUMBA	07/03/2014	19.1	6.62	181	-	-	59	86
HANGA 2B	07/03/2014	58	7.22	388	-	-	225	266
HANGA 2A	07/03/2014	35.9	6.74	267	-	-	114	152



GROUNDWATER SPECIALIST STUDY

Table 8: Macro Constituents (units in mg/L unless otherwise stated)

Site Name	Date	Ca	Mg	Na	F	Cl	K	SO ₄	NO ₃
US 201 drinking potable water specification class 2		75	50	400	1.5	500	100		5.00
WHO drinking water (2011)		Not of health concern at levels found in drinking-water		50	1.5	Not of health concern at levels found in drinking-water	Not of health concern at levels found in drinking-water	Not of health concern at levels found in drinking-water	50
Kyabasambu stream	10/12/2013	48	19.2	-	1.2	0.03	-	-	1.3
Busigi stream	10/12/2013	48	110.4	-	1.2	0.03	-	-	1.49
Ususa spring	10/12/2013	72	28.8	-	1	0.03	-	-	0.03
Senjojo stream	10/02/2014	136	-	-	1	0.03	-	-	0.03
Kachunde stream	10/02/2014	40	19.2	-	1	0.03	-	-	0.03
Kina shores	10/12/2013	32	43.2	-	0.9	0.03	-	-	4.4
Lake Albert	10/02/2014	27.2	34.6	-	0.9	0.03	-	-	0.04
Nsonga shorelines	10/02/2014	16	48	-	0.9	0.03	-	-	0.11
Ususa BH	06/03/2014	57.6	24.4	81	0.3	81.3	8.4	47.9	133.47
Ususa BH	10/02/2014	112	24	-	0.7	0.03	-	-	1.43
Kina BH	10/12/2013	2000	186	-	1.1	3.30	-	-	1.64
Kina BH	06/03/2014	1587	948.7	5845	-	14979.4	16.8	692.33	14.65





GROUNDWATER SPECIALIST STUDY

Site Name	Date	Ca	Mg	Na	F	Cl	K	SO ₄	NO ₃
US 201 drinking potable water specification class 2		75	50	400	1.5	500	100		5.00
WHO drinking water (2011)		Not of health concern at levels found in drinking-water		50	1.5	Not of health concern at levels found in drinking-water	Not of health concern at levels found in drinking-water	Not of health concern at levels found in drinking-water	50
Kyenyanja BH	10/12/2013	56	33.6	-	1	0.03	-	-	0.43
Busigi BH	10/12/2013	56	33.6	-	1.2	0.03	-	-	1.33
Kyenyanja BH	06/03/2014	21.8	28	87.4	0.8	56.6	49	19.12	19.88
Kyabasambu (CPF1)	06/03/2014	262.4	168	858.9	0.3	2420.9	4.2	-	2.21
KYANGWALI HQ	06/03/2014	19.9	5.5	8.3	0.4	16	2.8	10.34	2.30
KABALE 1	02/03/2014	34.1	18.7	0.03	-	5.30	2.7	40.26	1.02
KABALE 2	02/03/2014	12.4	5.8	0.03	-	0.7	1.5	5.12	2.17
KABALE 3	02/03/2014	33.8	20	0.03	0.5	3	1	17.08	1.15
KISOBA 1	02/03/2014	21.7	11.4	0.02	1	1	2.1	6.24	4.29
KISOBA 2	02/03/2014	39.7	20	0.02	1.3	15.6	2.5	17.41	0.75
KISOBA 3	02/03/2014	21.7	10.2	0.01	0.6	0.5	2.7	6.99	2.04
HOHWA 1	02/03/2014	35.2	37.2	0.05	2.7	3.5	1.2	14.32	8.54





GROUNDWATER SPECIALIST STUDY

Site Name	Date	Ca	Mg	Na	F	Cl	K	SO ₄	NO ₃
US 201 drinking potable water specification class 2		75	50	400	1.5	500	100		5.00
WHO drinking water (2011)		Not of health concern at levels found in drinking-water		50	1.5	Not of health concern at levels found in drinking-water	Not of health concern at levels found in drinking-water	Not of health concern at levels found in drinking-water	50
KABEGARAIRE 1	02/03/2014	30	24.6	0.01	0.3	2.4	2.8	24.9	0.66
KYARUSHESHA 1	02/03/2014	18.2	9.4	0.02	-	1.7	2.1	36.38	5.89
KASOGA 1	02/03/2014	61.4	17.5	0.02	1.7	1.4	2.8	18.04	0.75
KASOGA 2	07/03/2014	13.9	5.4	13.7	0.3	0.7	0.5	0.32	0.75
KYARUJUMBA	07/03/2014	13.5	6	14.1	0.5	0.5	2.7	6.18	2.21
HANGA 2B	07/03/2014	58.5	18.8	35.3	1.4	18	3.0	31.18	0.62
HANGA 2A	07/03/2014	24.8	12.4	31.7	1.1	9	1.8	16.41	2.35
Kyabasambu stream	10/12/2013	48	19.2	-	1.2	0.03	-	-	1.3
Busigi stream	10/12/2013	48	110.4	-	1.2	0.03	-	-	1.49
Ususa spring	10/12/2013	72	28.8	-	1	0.03	-	-	0.03
Senjojo stream	10/02/2014	136	-	-	1	0.03	-	-	0.03
Kachunde stream	10/02/2014	40	19.2	-	1	0.03	-	-	0.03





GROUNDWATER SPECIALIST STUDY

Site Name	Date	Ca	Mg	Na	F	Cl	K	SO ₄	NO ₃
US 201 drinking potable water specification class 2		75	50	400	1.5	500	100		5.00
WHO drinking water (2011)		Not of health concern at levels found in drinking-water		50	1.5	Not of health concern at levels found in drinking-water	Not of health concern at levels found in drinking-water	Not of health concern at levels found in drinking-water	50
Kina shores	10/12/2013	32	43.2	-	0.9	0.03	-	-	4.4
Lake Albert	10/02/2014	27.2	34.6	-	0.9	0.03	-	-	0.04
Nsonga shorelines	10/02/2014	16	48	-	0.9	0.03	-	-	0.11
Ususa BH	06/03/2014	57.6	24.4	81	0.3	81.3	8.4	47.9	133.47
Ususa BH	10/02/2014	112	24	-	0.7	0.03	-	-	1.43
Kina BH	10/12/2013	2000	186	-	1.1	3.30	-	-	1.64
Kina BH	06/03/2014	1587	948.7	5845	-	14979.4	16.8	692.33	14.65
Kyenyanya BH	10/12/2013	56	33.6	-	1	0.03	-	-	0.43
Busigi BH	10/12/2013	56	33.6	-	1.2	0.03	-	-	1.33
Kyenyanya BH	06/03/2014	21.8	28	87.4	0.8	56.6	49	19.12	19.88
Kyabasambu (CPF1)	06/03/2014	262.4	168	858.9	0.3	2420.9	4.2	-	2.21
KYANGWALI HQ	06/03/2014	19.9	5.5	8.3	0.4	16	2.8	10.34	2.30





GROUNDWATER SPECIALIST STUDY

Site Name	Date	Ca	Mg	Na	F	Cl	K	SO ₄	NO ₃
US 201 drinking potable water specification class 2		75	50	400	1.5	500	100		5.00
WHO drinking water (2011)		Not of health concern at levels found in drinking-water		50	1.5	Not of health concern at levels found in drinking-water	Not of health concern at levels found in drinking-water	Not of health concern at levels found in drinking-water	50
KABALE 1	02/03/2014	34.1	18.7	0.03	-	5.30	2.7	40.26	1.02
KABALE 2	02/03/2014	12.4	5.8	0.03	-	0.7	1.5	5.12	2.17
KABALE 3	02/03/2014	33.8	20	0.03	0.5	3	1	17.08	1.15
KISOBA 1	02/03/2014	21.7	11.4	0.02	1	1	2.1	6.24	4.29
KISOBA 2	02/03/2014	39.7	20	0.02	1.3	15.6	2.5	17.41	0.75
KISOBA 3	02/03/2014	21.7	10.2	0.01	0.6	0.5	2.7	6.99	2.04
HOHWA 1	02/03/2014	35.2	37.2	0.05	2.7	3.5	1.2	14.32	8.54
KABEGARAIRE 1	02/03/2014	30	24.6	0.01	0.3	2.4	2.8	24.9	0.66
KYARUSHESHA 1	02/03/2014	18.2	9.4	0.02	-	1.7	2.1	36.38	5.89
KASOGA 1	02/03/2014	61.4	17.5	0.02	1.7	1.4	2.8	18.04	0.75
KASOGA 2	07/03/2014	13.9	5.4	13.7	0.3	0.7	0.5	0.32	0.75
KYARUJUMBA	07/03/2014	13.5	6	14.1	0.5	0.5	2.7	6.18	2.21





GROUNDWATER SPECIALIST STUDY

Site Name	Date	Ca	Mg	Na	F	Cl	K	SO ₄	NO ₃
US 201 drinking potable water specification class 2		75	50	400	1.5	500	100		5.00
WHO drinking water (2011)		Not of health concern at levels found in drinking-water		50	1.5	Not of health concern at levels found in drinking-water	Not of health concern at levels found in drinking-water	Not of health concern at levels found in drinking-water	50
HANGA 2B	07/03/2014	58.5	18.8	35.3	1.4	18	3.0	31.18	0.62
HANGA 2A	07/03/2014	24.8	12.4	31.7	1.1	9	1.8	16.41	2.35



5.4.3.2 Macro Chemistry

The macro chemistry consists of the major cations and anions that contributed to the salinity of the groundwater, Table 8 . It can therefore be expected that the samples that showed elevated salinity will have corresponding elevated cations and anions. The major contributing cations to high salinity down at the lake from is Na and Ca, and to a lesser extent Mg. Cl and SO₄ is the major anion contributors to salinity and the Kina borehole have a very high Cl content of nearly 15 000mg/L. Nitrate (NO₃) is another anion that is problematic and is suspected to be sourced from poor sanitation practices. Bicarbonate is the major anion of the escarpment boreholes.

Piper diagrams are used to characterise the groundwater (Figure 10). The Piper plots include two triangles, one for plotting cations and the other for plotting anions. The cations and anion fields are combined to show a single point in a diamond-shaped field, from which inference is drawn on the basis of hydro-geochemical facies concept. These tri-linear diagrams are useful in bringing out chemical relationships among groundwater samples in more definite terms than is possible with other plotting methods.

From the plotted Piper Diagram, it can be seen that most of the escarpment boreholes can be characterised as Ca/Mg bicarbonate type water, which is expected from the type of geology and recharge mechanisms (rapid recharge after rainfall events) occurring on the escarpment.

The groundwater character of the lake front boreholes is less distinct, and most can be classified as Na Mg – bicarbonate with enrichment of Cl that contribute to the elevated salinity. The source of the Cl in groundwater cannot be directly linked to the lake water since the lake water samples (Kina shores, Lake Albert, Nsonga shorelines) all had very low Cl values (0.03 mg/L). The build-up of salts on the lake front plains is the result of evapotranspiration and a seasonal water level fluctuation. It is assumed that the gradient of groundwater flow towards the lake on the flats is very low and this will also contribute to the salinization of the upper soil profiles.

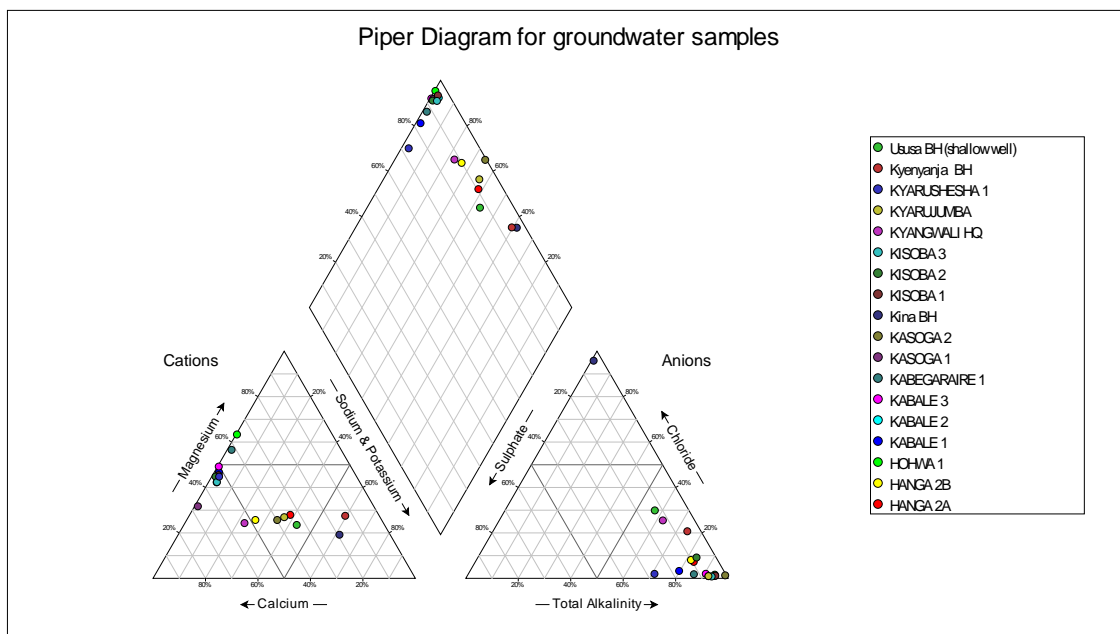

Figure 10: Piper diagram for the groundwater samples





5.4.3.3 *Micro Chemistry*

To determine the micro chemistry of the groundwater, a number of parameters were included in the analyses that include a wide range of trace metals. The trace metals that had positive detections are listed in Table 9.

Several trace metals exceed the set guidelines at a number of sampling points. These are: Mn, Fe, Al, Se, Pb and Hg. Pb and Hg is often associated with crude oil and natural gas occurrences but in this case the source is likely from natural groundwater leaching of the bedrock gneiss and granite. Mn, Al, Se, and Fe were also detected above guideline values at several of the sites. These elements are also associated with the gneiss and granite bedrock formations.

These elements are likely to pose a health risk in the long-term for users of the water resource.

5.4.3.4 *Organic Chemistry*

The samples taken during the March 2013 sample run were submitted for organic analyses consisting of Poly aromatic Hydrocarbons (PAH), Extractable Petroleum hydrocarbons (EPH), and Gasoline Range Organics. The analyses were *below detection for all the organic parameters tested in the submitted samples.*



Table 9: Micro constituents (units in mg/L unless otherwise stated)

Site Name	Date	NH ₃	PO ₄	Total P	Total N	Cr	Pb	Hg	Fe
US 201 drinking portable water		1		10	10	0.05	0.01	0.001	0.03 - 3.5
WHO drinking water (2011)		Not of health concern at levels found in drinking-water	-	-	-	0.05	0.01	0.006	Not of health concern at levels found in drinking-water
Kyabasambu stream	10/12/2013	0.50	-	0.07	0.13	-	-	0.001	0.05
Busigi stream	10/12/2013	-	-	0.26	0.06	0.0002	0.0006	0.0011	0.01
Ususa spring	10/12/2013	0.20	-	0.15	0.29	0.001	-	-	0.01
Senjojo stream	10/02/2014	-	-	0.05	0.31	-	-	-	0.01
Kachunde stream	10/02/2014	-	-	0.10	0.28	0.0004	-	-	0.02
Kina shores	10/12/2013	-	-	0.05	0.37	0.0002	0.0004	0.0012	0.01
Lake Albert	10/02/2014	-	-	0.05	0.27	0.0004	0.0025	0.001	0.02
Nsonga shorelines	10/02/2014	-	-	0.15	0.12	0.0003	0.0025	0.0011	0.04
Ususa BH (shallow well)	06/03/2014	0.27	1.35	-	-	-	0.01	-	-
Ususa BH (shallow well)	10/02/2014	-	-	0.17	2.67	0.001	-	-	0.04
Kina BH	10/12/2013	-	-	0.04	1.18	-	-	-	0.06
Kina BH	06/03/2014	0.74	-	-	-	-	0.02	-	0.22
Kyenyanya BH	10/12/2013	-	-	0.55	0.42	0.0003	-	0.001	-





GROUNDWATER SPECIALIST STUDY

Site Name	Date	NH ₃	PO ₄	Total P	Total N	Cr	Pb	Hg	Fe
US 201 drinking portable water		1		10	10	0.05	0.01	0.001	0.03 - 3.5
WHO drinking water (2011)		Not of health concern at levels found in drinking-water	-	-	-	0.05	0.01	0.006	Not of health concern at levels found in drinking-water
Busigi BH	10/12/2013	-	-	0.17	2.45	0.001	-	-	-
Kyenyanya BH	06/03/2014	0.44	2.48	-	-	-	-	-	-
Kyabasambu (CPF1)	06/03/2014	0.52	-	-	-	-	0.02	-	0.04
KYANGWALI HQ	06/03/2014	0.19	0.06	-	-	-	0.05	-	0.46
KABALE 1	02/03/2014	0.18	-	-	-	-	0.02	-	0.66
KABALE 2	02/03/2014	0.23	-	-	-	-	0.02	-	0.94
KABALE 3	02/03/2014	0.22	-	-	-	-	0.01	-	0.22
KISOBA 1	02/03/2014	0.86	-	-	-	-	0.02	-	0.85
KISOBA 2	02/03/2014	0.38	-	-	-	-	0.01	-	0.15
KISOBA 3	02/03/2014	0.36	-	-	-	-	0.01	-	0.03
HOHWA 1	02/03/2014	0.27	-	-	-	-	0.01	-	-
KABEGARAIRE 1	02/03/2014	0.30	-	-	-	-	0.02	-	2.06
KYARUSHESHA 1	02/03/2014	0.40	-	-	-	-	0.01	-	0.32
KASOGA 1	02/03/2014	0.41	-	-	-	-	0.01	-	0.98





GROUNDWATER SPECIALIST STUDY

Site Name	Date	NH ₃	PO ₄	Total P	Total N	Cr	Pb	Hg	Fe
US 201 drinking portable water		1		10	10	0.05	0.01	0.001	0.03 - 3.5
WHO drinking water (2011)		Not of health concern at levels found in drinking-water	-	-	-	0.05	0.01	0.006	Not of health concern at levels found in drinking-water
KASOGA 2	07/03/2014	0.40	-	-	-	-	0.01	-	1.09
KYARUJUMBA	07/03/2014	0.46	0.19	-	-	-	0.01	-	0.82
HANGA 2B	07/03/2014	0.40	-	-	-	0.009	0.02	-	1.00
HANGA 2A	07/03/2014	0.15	-	-	-	-	0.01	-	1.03



GROUNDWATER SPECIALIST STUDY

Site Name	Date	Al	Ba	Cu	Mn	Zn	Co	Ni	Se	Si	V
US 201 drinking portable water		0.2		1	0.1 -0.5	3		0.02	0.01	-	-
WHO drinking water (2011)		A health-based value of 0.9 mg/l could be derived, but this value exceeds practicable levels based on coagulation process in drinking-water plants	-	2	Not of health concern at levels causing acceptability problems in drinking-water	Not of health concern at levels found in drinking-water	-	0.07	0.04	-	-
Kyabasambu stream	10/12/2013	-	-	-	0.0016	-	-	-	0.01	-	-
Busigi stream	10/12/2013	-	-	-	0.0013	-	-	-	0.016	-	-
Ususa spring	10/12/2013	-	-	-	0.0005	-	-	-	0.013	-	-
Senjojo stream	10/02/2014	-	-	-	-	-	-	-	0.011	-	-
Kachunde stream	10/02/2014	0.17	-	-	0.0007	-	0.001	-	0.013	-	-
Kina shores	10/12/2013	-	-	-	0.0004	-	0.001	-	0.012	-	-
Lake Albert	10/02/2014	0.19	-	-	0.0008	-	0.001	-	0.024	-	-
Nsonga shorelines	10/02/2014	0.03	-	-	0.0007	-	0.001	-	0.014	-	-
Ususa BH (shallow well)	06/03/2014	0.17	0.19	-	0.598	0.06	-	-	-	27.4	0.02
Ususa BH (shallow well)	10/02/2014	-	-	-	0.16	0.00	-	-	0.0027	-	-
Kina BH	10/12/2013	-	-	-	0.119	0.21	0.001	-	-	-	-





GROUNDWATER SPECIALIST STUDY

Site Name	Date	Al	Ba	Cu	Mn	Zn	Co	Ni	Se	Si	V
US 201 drinking portable water		0.2		1	0.1 -0.5	3		0.02	0.01	-	-
WHO drinking water (2011)		A health-based value of 0.9 mg/l could be derived, but this value exceeds practicable levels based on coagulation process in drinking-water plants	-	2	Not of health concern at levels causing acceptability problems in drinking-water	Not of health concern at levels found in drinking-water	-	0.07	0.04	-	-
Kina BH	06/03/2014	-	0.10	-	0.04	0.20	-	0.002	-	42.10	-
Kyenyanya BH	10/12/2013	-	-	0.0009	0.001	-	-	-	0.013	-	-
Busigi BH	10/12/2013	-	-	-	0.01	-	-	-	0.016	-	-
Kyenyanya BH	06/03/2014	0.05	0.09	-	0.01	0.02	-	-	-	6.2	0.02
Kyabasambu (CPF1)	06/03/2014	-	3.05	-	1.54	0.19	-	-	-	34.1	-
KYANGWALI HQ	06/03/2014	0.07	0.11	-	0.002	2.48	-	-	-	55.6	0.0017
KABALE 1	02/03/2014	-	0.09	-	0.01	0.07	-	0.002	-	53.1	0.01
KABALE 2	02/03/2014	1.10	0.08	0.01	0.06	0.03	-	0.002	-	61.8	0.003
KABALE 3	02/03/2014	-	0.18	-	0.13	0.05	-	-	-	25.9	-
KISOBA 1	02/03/2014	-	0.14	0.01	0.03	0.04	-	-	-	37.6	0.003
KISOBA 2	02/03/2014	-	0.17	0.04	0.13	0.07	-	-	-	36.7	-
KISOBA 3	02/03/2014	-	0.16	-	0.03	0.17	-	-	-	32.2	-



GROUNDWATER SPECIALIST STUDY

Site Name	Date	Al	Ba	Cu	Mn	Zn	Co	Ni	Se	Si	V
US 201 drinking portable water		0.2		1	0.1 -0.5	3		0.02	0.01	-	-
WHO drinking water (2011)		A health-based value of 0.9 mg/l could be derived, but this value exceeds practicable levels based on coagulation process in drinking-water plants	-	2	Not of health concern at levels causing acceptability problems in drinking-water	Not of health concern at levels found in drinking-water	-	0.07	0.04	-	-
HOWWA 1	02/03/2014	-	0.14	-	0.05	0.03	-	-	-	33.9	0.01
KABEGARAIRE 1	02/03/2014	-	0.04	-	0.10	0.13	-	-	-	33.4	-
KYARUSHESHA 1	02/03/2014	0.27	0.06	-	0.08	0.02	-	-	-	36.0	0.01
KASOGA 1	02/03/2014	-	0.20	-	0.35	0.01	-	-	-	46.9	-
KASOGA 2	07/03/2014	0.21	0.08	-	0.05	0.06	-	-	-	32.2	0.0018
KYARUJUMBA	07/03/2014	-	0.12	-	0.01	0.09	-	-	-	36.6	0.0048
HANGA 2B	07/03/2014	-	0.13	-	0.31	0.05	-	-	-	38.5	-
HANGA 2A	07/03/2014	-	0.13	-	0.10	0.03	-	-	-	49.4	0.004





5.4.3.5 Microbial Water Quality

As noted earlier, one of the complaints recorded by the communities was the water quality causing outbreaks of diarrhoea and cholera. It was suspected that the microbial water quality is poor in most of the water sources. To confirm this; the water had to be tested for bacteriological counts. Due to the distance from accredited laboratories, water samples at Kingfisher and along the pipeline could not be submitted for microbial testing at a laboratory. As an alternative the water was tested using Colitag™1. Colitag™ is a Presence/Absence and MPN (most probable number) enzyme substrate test that detects as few as 1 MPN of total coliform and E. coli bacteria per 100mL water sample. Results can be read any time between 16 and 48 hours. Generally, water is not considered potable if there are more than 1 MPN/100mL (or CFU/100mL) E.coli in a water sample.

Water pollution caused by faecal contamination is a serious problem contributing to diseases from pathogens (disease causing organisms). Frequently, concentrations of pathogens from faecal contamination are small, and the number of different possible pathogens is large. As a result, it is not practical to test for pathogens in every water sample collected. Instead, the presence of pathogens is determined with indirect evidence by testing for an "indicator" organism such as coliform bacteria. Coliforms come from the same sources as pathogenic organisms. Coliforms are relatively easy to identify, are usually present in larger numbers than more dangerous pathogens, and respond to the environment, wastewater treatment, and water treatment similarly to many pathogens. As a result, testing for coliform bacteria can be a reasonable indication of whether other pathogenic bacteria are present.

The most basic test for bacterial contamination of a water supply is the test for total coliform bacteria. Total coliform counts give a general indication of the sanitary condition of a water supply. Total coliforms include bacteria that are found in the soil, in water that has been influenced by surface water, and in human or animal waste. Faecal coliforms are the group of the total coliforms that are considered to be present specifically in the gut and faeces of warm-blooded animals. Because the origins of faecal coliforms are more specific than the origins of the more general total coliform group of bacteria, faecal coliforms are considered a more accurate indication of animal or human waste than the total coliforms.

Escherichia coli (E. coli) is the major species in the faecal coliform group. Of the five general groups of bacteria that comprise the total coliforms, only E. coli is generally not found growing and reproducing in the environment. Consequently, E. coli is considered to be the species of coliform bacteria that is the best indicator of faecal pollution and the possible presence of pathogens. The results from the Colitag™, therefore gives an indication of the presence of Total coliform and E. coli bacteria in the water samples.

Samples were taken from all the hydrocensus boreholes, springs, the gravity flow system, and Lake Albert to test for the bacteria. Results are indicated in Table 10 and full results with photographs and site descriptions are provided in APPENDIX B.

Table 10: Colitag™ test results

Table with 3 columns: Location, Total coliforms, and E. coli. Rows include Kingfisher (Buhuka Flat) and various CPF sites (KYABASAMBU, NSONGA, LAKE-JETTY, GRAVITY FLOW).

1 Colitag™ is a Presence/Absence and MPN (most probable number) enzyme substrate test that detects as few as 1 MPN of total coliform and E. coli bacteria per 100mL water sample. Results can be read any time between 16 and 48 hours. Generally water is not considered potable if there are more than 1 MPN/100mL (or CFU/100mL) E.coli in a water sample





	Total coliforms	<i>E. coli</i>
USUSA BH	no	no
USUSA SPRING	yes	yes
KENYANYA BH	yes	yes
KYENYANYA SPRING	yes	yes
BUSIGI BH	yes	no
BUSIGI SPRING	yes	yes
KIINA	no	no
GRAVITY FLOW-KIINA	yes	yes
KACUMDE SPRING	yes	yes
LAKE-KACUMDE	yes	yes
LAKE-JETTY	yes	yes
LAKE-JETTY DUP	yes	yes
KYABASAMBU STREAM	yes	yes
Along the pipeline		
KABALE 1	no	no
KABALE 2	no	no
KABALE 3	yes	yes
KISOBA 1-STREAM (NYANKEREBE)	yes	yes
KISOBA 2	yes	yes
KISOBA 3	yes	yes
HOHWA	yes	yes
KABEGARAMIRE 1	yes	yes
KYARUSHESHA	yes	yes
KASOGA 1-SPRING	yes	yes
KASOGA 2	yes	yes
KYARUJUMBA	no	no
HANGA 2A	no	no
HANGA2B	yes	yes
KYANGWALI –NYAKATEHE I	no	no





From the results it can be seen that from the surface water samples tested that 100% tested positive for total Coliforms and *E.coli*. The boreholes on the Buhuka flats and lake front villages had a 71% positive result. Similarly, the escarpment villages along the pipeline had a 72% positive result. This shows that the majority of the water sources utilised by communities for domestic use in both areas are not fit for use. The water quality is negatively influenced by poor or non-existing sanitation practices.

5.4.4 Hydrogeological Conceptual Model

The groundwater resources at the Kingfisher Project site and associated pipeline infrastructure can be summarised as followed:

- On the Buhuka flat and lake front villages the groundwater is utilised as a source of domestic water through shallow wells and deeper installed wells. Most are equipped with hand pumps and sealed at surface;
- The groundwater is assumed to be associated with the bedrock formations consisting of granite, gneiss or quartzite formations on the escarpment and with sediments such as sandstone down at the lake front. All geological information was limited to National database information and no ground truthing through drilling was done;
- In general, on the flats next to the lake, the first 50 m below ground is dominated by sand, increasingly interbedded with clay layers at depth, but the sequence of sands and clays is not laterally continuous. Hydrogeologically, the sand deposits can provide reasonably productive aquifers. Rivers crossing the area typically lose water, demonstrating infiltration into the permeable sandy deposits. However, the frequent interbedded clay layers break the sand deposits up into hydraulically isolated units. Borehole yields are highly variable, and even when yields are good, the boreholes would not support sustained abstraction at high rates (Figure 11).
- Water level elevations were interpolated for the area, and static water levels showed great variation between 1m to 63m below ground level. The variability in water levels confirms the fractured and thus heterogeneous character of the aquifers;
- Groundwater levels are about 10 m below ground level (mbgl) near the lake shore, with depth to water increasing inland as the topography rises. Correcting the groundwater levels into metres above datum, a hydraulic gradient is revealed, driving groundwater flow towards the lake, in a similar pattern to surface water. Groundwater levels just inland from the lake appear to be below lake level; this could just be because datum levels are inaccurate, or it could represent a groundwater discharge zone.
- Water quality on the Buhuka flats are very poor and characterised by very high salinity (and corrosive character) caused by accumulation of salts from evapotranspiration and seasonal water fluctuations;
- Water quality along the escarpment villages was generally acceptable with some trace metals exceeding the drinking water guidelines;
- No organic (petroleum) hydrocarbons were detected in any of the samples; and
- Microbial water quality was very poor and most of the water sources including the lake water tested positive for Coliforms and *E.coli*. The cause of this is most likely due to poor or non-existing sanitation practices.

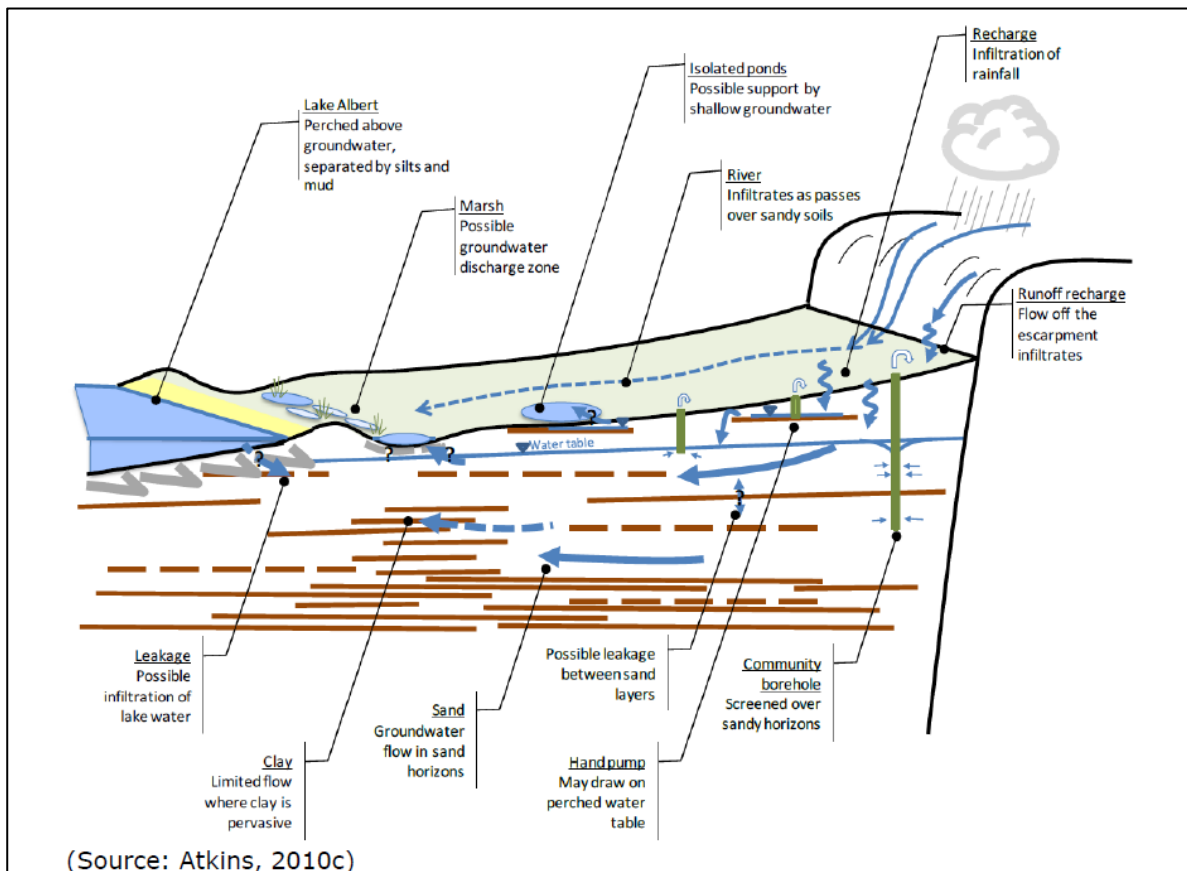

Figure 11: Site hydrogeological conceptualisation from Atkins, 2010





6.0 IMPACT ASSESSMENT

6.1 Impact Assessment Rating of Potential Impacts

The methodology and approach followed during impact assessment in the detailed ESIS is described below.

Potential impacts during the construction, operational and decommissioning/restoration phases of the project are considered separately in the ESIA.

The impact assessment process compares the magnitude of the impact with the sensitivity of the receiving environment. This method relies on a detailed description of both the impact and the environmental or social component that is the receptor. The magnitude of an impact depends on its characteristics, which may include such factors as its duration, reversibility, area of extent, and nature in terms of whether positive, negative, direct, indirect or cumulative.

Once the magnitude of the impact and the sensitivity of the receiving environment have been described, the significance of the potential impact can be determined. The determination of significance of an impact is largely subjective and primarily based on professional judgment.

The types of potential Project impacts considered appropriate for the groundwater assessment are summarised in Table 11.

Table 11: Types of Potential Groundwater Impacts

Direct Impact	Impacts that result from a direct interaction between a planned project activity and the receiving environment/receptors
Cumulative impact	Impacts that act together or combine with other impacts (including those from concurrent or planned activities) to affect the same resources and/or receptors of the Project.

To provide a relative illustration of impact significance, it is useful to assign numerical descriptors to the impact **magnitude** and receptor **sensitivity** for each potential impact. Each is assigned a numerical descriptor of 1, 2, 3, or 4, equivalent to very low, low, medium or high (Table 12). The significance of impact is then indicated by the product (multiplication) of the two numerical descriptors, with significance being described as negligible, minor, moderate or major, as in Table 13. This is a qualitative method designed to provide a broad ranking of the different impacts of a project.





Table 12: Determination of impact significance

			Sensitivity of receptor			
			Very low	Low	Medium	High
			1	2	3	4
Magnitude of Impact	Very low	1	1 Negligible	2 Minor	3 Minor	4 Minor
	Low	2	2 Minor	4 Minor	6 Moderate	8 Moderate
	Medium	3	3 Minor	6 Moderate	9 Moderate	12 Major
	High	4	4 Minor	8 Moderate	12 Major	16 Major

Table 13: Impact assessment criteria and rating scale

Criteria	Rating scales
Magnitude (the expected magnitude or size of the impact)	Negligible - where the impact affects the environment in such a way that natural, and /or cultural and social functions and processes are negligibly affected and valued, important, sensitive or vulnerable systems or communities are negligibly affected.
	Low - where the impact affects the environment in such a way that natural, and/or cultural and social functions and processes are minimally affected and valued, important, sensitive or vulnerable systems or communities are minimally affected. No obvious changes prevail on the natural, and / or cultural/ social functions/ process as a result of project implementation
	Medium - where the affected environment is altered but natural, and/or cultural and social functions and processes continue albeit in a modified way, and valued, important, sensitive or vulnerable systems or communities are moderately affected.
	High - where natural and/or cultural or social functions and processes are altered to the extent that they will temporarily or permanently cease, and valued, important, sensitive or vulnerable systems or communities are substantially affected. The changes to the natural and/or cultural / social- economic processes and functions are drastic and commonly irreversible
Sensitivity of the Receptor	Low – where natural recovery of the impacted area to the baseline or pre-project condition is expected in the short-term (1-2 years), or where the potentially impacted area is already disturbed by non-project related activities occurring on a scale similar to or larger than the proposed activity
	Medium – where natural recovery to the baseline condition is expected in the medium term (2-5 years), and where marginal disturbance or modification of the receiving environment by existing activities is present.
	High – where natural recovery of the receiving environment is expected in the long-term (>5 years) or cannot be readily predicted due to uncertainty over the nature of the potential impact, and where unique or highly valued ecological, social or cultural resources could be adversely affected.





6.2 Construction Phase Impacts

From a hydrogeological perspective, the following section summarises the potential impacts that are related to the construction phase of Kingfisher Well Field Development, and provides a significance rating for each impact before and after mitigation (Table 14). The construction phase activities that could potentially impact on the groundwater resource include the materials handling, water demand, and waste generation associated with the following elements:

- Residential, ablution, kitchen and administration facilities for Contractors and CNOOC workers;
- Drilling of oil production wells and the water injection wells from the five well site locations adjacent to the banks of Lake Albert;
- Construction of a 40,000 bopd design capacity CPF on the Lake Albert Buhuka Plain;
- Linking of the well sites to the CPF by buried, heated and insulated production flow lines, water injection lines, electrical cables, and fibre optic cables;
- Construction of a water intake and water extraction pump station on the shore of Lake Albert to the beach, a water extraction pump station on the beach, and a buried water transfer pipeline to the CPF;
- Construction of permanent operators' accommodation near the CPF;
- Construction of a power station at the CPF fuelled by produced gas from the CPF during initial years of production and by crude oil during the later years of production;
- Construction of a pump station at the CPF and a heated, insulated, ~50km crude oil transmission pipeline from the CPF to Kabaale; and
- Construction of a buried high voltage electrical transmission line from the CPF to Kabaale to power pipeline heating stations and block valve stations.

Currently, there is an existing Bugoma drilling camp in Kingfisher that accommodates the crews undertaking field planning and rehabilitation of some field infrastructure ahead of the anticipated field development program. Kingfisher field construction and the production phase will however necessitate a number of various crews that will undertake among other activities, the construction and upgrade of the necessary infrastructure (pipeline, CPF, well sites among others), drilling, production and processing, management of crude export along the pipeline and other support service contractors. These activities are intensive and necessitate resident specialized crews to be accommodated in close proximity to their work stations. Since however, the temporal occupation of the various crews is not uniform and only dependent on the lifespan of the particular project component, there is a consideration to have more than one camp for the project to include:

- The drilling crew camp (drilling camp) – which is the existent current Bugoma camp and can accommodate a maximum of about 250 people.
- Two temporary construction camps will be required: One is dedicated to the CPF and in-field facilities and the other is associated with the crude oil pipeline construction. The CPF and In-field Construction camp would be located on the Buhuka flats north of the CPF. The camp will comprise accommodation, messing and welfare facilities for the labour force undertaking the construction and commissioning work. The construction camp dedicated to the construction of the export pipeline from Kingfisher CPF to Kabaale would be significantly smaller than the main Kingfisher Construction camp and would be fully self-sufficient comprising power generation, water treatment and sewage and waste disposal.

6.2.1 Abstraction of groundwater for potable use

Groundwater on the Buhuka flats is not seen as a sustainable or potable source of water. The main water supply for the Project will be from Lake Albert and therefore abstraction of groundwater is not considered to be an associated impact of the Project. However, should later investigations prove that groundwater



abstracted from deeper aquifers (not yet explored) is an option for water supply, the abstraction and associated impacts on the groundwater system will have to be reassessed, defined, and quantified.

6.2.2 Generation of domestic waste water discharge

Domestic waste water from the construction camp kitchen, bathrooms, residential block, and administration areas will be discharged in subsurface drains, until the permanent waste water treatment plant is completed. There is no current detail information on the expected volumes of domestic waste water that will be generated and the design of the systems. The impact description is therefore based on experiences from similar projects.

The presence of the additional workers on site during construction will increase the pressure on the sewage water systems and potential for overloading the existing waste water treatment systems is possible. This could result in spillages and malfunctioning of drain systems, which can lead to shallow groundwater pollution.

The impact for this activity (i.e. potential for groundwater pollution) is rated at **moderate** (9) before mitigation, because of the medium sensitivity and magnitude of the impact expected without mitigation. Post mitigation the impact will be **minor** (4).

Mitigation measures include:

- Adequate design and management to handle the expected volumes of effluent and allow drainage in order not to cause flooding or over saturation of the subsurface.
- Downstream groundwater monitoring of the systems is recommended especially in the case where groundwater may be used for domestic supply.
- Solid and liquid waste must remain contained and quarantined, and be disposed of at an appropriately licenced facility (a register containing safe disposal receipts should be maintained on site);
- Bins must be provided on site for both contractors and security personnel. Litter must be removed from site and disposed of correctly; and

6.2.3 Generation of sanitation waste– well pads and pipeline construction

During the construction phase of the well pads and pipeline (located away from the Construction camp), sanitation waste will be generated by workers. There are no permanent ablution facilities associated with these construction sites, and the workers will have to be provided with adequate sanitation solutions on site to prevent the disposal of waste in unsanitary manners. The informal disposal of these wastes can lead to pollution of the groundwater resources at the construction sites.

The impact from this activity can potentially be **moderate** (9) if local communities along the pipeline route's groundwater resources are polluted from the waste disposal which can cause the outbreak of waterborne diseases such as cholera. The impact can however be reduced to **minor** (4) if adequate mitigation measures are put in place.

Mitigation will typically be the provision of clean water or hand washing and provision of portable toilets at the construction sites. These portable toilets need to be managed and maintained in a manner that will protect the environment.

6.2.4 Waste generated during the maintenance of equipment and machinery

Hazardous waste materials will be generated during the construction phase ranging from used solvents, used oil and grease, etc. The magnitude of the groundwater impact of the generation of hazardous waste before mitigation is expected to be **major** (12), because of high sensitivity of groundwater.



Mitigation measures include:

- Vehicles/ machinery must be maintained and serviced when necessary to prevent leaks and breakdowns. As a minimum, the following must be done:
 - Avoid overfilling of tanks;
 - Ensure correct disposal of hydrocarbons such as lubricants and oils.
 - Toxic chemicals (e.g. fuel, lubricants and oils) must be kept within an appropriate bund;
 - Vehicles must be parked in a designated place with drip trays and spill kits readily available;
 - All vehicles must be regularly serviced and in good working order.
 - Ensure an appropriately trained person is on site at all times to quickly deal with spills.
- Vehicles/ machinery must be kept at least 100m from water resources;

After the implementation of mitigation measures, the magnitude can be reduced to **minor** (4) and the potential impact will be of short term and limited to the directly affected site.

6.2.5 Accidental spills of materials stored and handled

It is expected that large volumes of potential hazardous materials will be stored and handled at the CPF construction site. The risk for a spill has to be considered as a potential impact. The magnitude of the impact is considered to be **major** (12) before mitigation measures are adopted.

Mitigation of these types of impacts will include the setup of site specific risk assessments and materials handling procedures by construction workers. All chemicals (e.g. fuel, lubricants and oils) must be kept within an appropriate bunded areas. All workers should be made aware of the risks associated with handling these hazardous materials and spill prevention and clean-up measures. With these applied mitigation measures the impact on the groundwater can be reduced to **minor** (4).

6.2.6 Domestic Waste generation

The influx of construction workers and permanent staff on the flats will cause the generation of domestic waste from the residential and construction camp. The wastes generated will typically constitute food packaging, food waste, plastic bags, and bottles, etc.

Potentially if the domestic waste is not properly disposed of or managed it can lead to groundwater pollution at the waste disposal site. A formal waste management plan that includes re-use and recycling will be required to reduce the impact from this activity on the groundwater source.

The EPC contractor will be required to comply with Ugandan Waste Regulations and IFC waste management guidelines, which encompass the principles of the waste hierarchy. Waste generation and waste disposed to landfill will be minimised. All re-usable and recyclable waste will be separated at source from waste destined for disposal to landfill. Waste will be labelled and stored in covered temporary storage areas, for collection.

The impact is therefore rated as **moderate** (9) before mitigation and after mitigation can reduce to **minor** (4).

6.2.7 Well drilling

All 40 wells are proposed to be drilled from five onshore well pads: Pad 1, Pad 2, Pad 3, Pad 4-2 and Pad 5. Amongst those well pads, Pad 1, Pad 2 and Pad 3 are already existing pads. A typical pad for drilling will be approximately 200m by 100m in size. These will be fenced facilities.



During the drilling phase, a typical well pad will include a rig and auxiliary facilities, drill waste pits, fuel tank storage area, drilling fluids preparation area and mud tank, flare pits for emergency use, control rooms, fence among others. All five well pads including three existing well pads will be constructed and/or upgraded to meet development well drilling requirements. It should be noted that drilling operations of development wells shall continue after the onset of the first oil production. Therefore, the construction phase and operation phase will overlap for this task.

The potential impacts on the groundwater resource from drilling are caused by:

- Drill fluids management and disposal;
- Mud cuttings disposal;
- Materials handling; and
- Well blow-out.

There will be two types of drill fluids to be used at Kingfisher Project: Water Based Mud (WBM) and Synthetic Based Drilling Mud (SBM). WBM will be used to drill the upper portions of the well (26" hole section) only and is designed to be environmentally friendly and its constituents will typically include:

- Water, from Lake Albert
- Bentonite (naturally occurring montmorillonite clays)

It is known that the WBM with constituents listed above pose little or no ecological risk. "Saraline 185V" as the base product for SBM has been selected based primarily on its acceptability in the drilling environment and extensive testing on the fluid to determine its impact on the environment. Extensive testing has been conducted over a number of years to validate its non-toxicity in the water column and biodegradability.

The main concern for use of SBMs is safe disposal of SBM associated drill cuttings. Drilled cuttings removed from the wellbore are typically the largest waste streams generated during oil and gas drilling activities. The impacts on the groundwater from drilling fluids will thus be related to improper handling and disposal of the drill fluids and cuttings that can cause groundwater pollution. However, to the use of the selected drill fluids the impact is rated as **moderate** (9) before mitigation and reduce to **moderate** (6), with a lower sensitivity, after considering the mitigation measures in place to safely handle and store drill fluids.

A well blow-out is the uncontrolled release of crude oil from a well, resulting in the release of hydrocarbons, water-based mud and/or water. Blow-outs can occur during exploration or development drilling. They can also occur in the production stage, for instance during maintenance work on a well or due to escalation of a collision or a fire or explosion on the platform. The risk of a blow-out is minimal and not all blow-outs have significant environmental impacts. A blow-out will last until the well is under control again. This may take anywhere from a few hours if control can be regained using the safety systems, up to several months if an additional well needs to be drilled to regain control over the first well. Experience has shown that control over wells can be regained in one or a few days if a blow-out should occur.

The crude oil mixture released during a blow-out, will have a detrimental effect on groundwater systems if not brought under control timeously; and is potentially the most severe and long-term environmental impact associated with oil and gas projects. However, blow out incidents are limited by the use of technology advances in drilling techniques and fluid management. The impact is listed here as **Major** (16) based on the potential to cause detrimental damage to aquifers and other water sources in the case of a blow-out. The mitigation measures reduce the impact to **moderate** (9) based on the low likelihood of such an incident occurring.



Table 14: Construction Phase Impacts

Receptor	Description	Type of Impact	Pre-mitigation			Post-mitigation		
			Sensitivity	Magnitude of Impact	Impact Significance	Sensitivity	Magnitude of Impact	Impact Significance
Groundwater	Pollution from domestic waste water discharge	Direct	Medium	Medium	9 Moderate	Low	Low	4 Minor
Groundwater	Pollution from sanitation waste - well pads and pipeline construction	Direct	Medium	Medium	9 Moderate	Low	Low	4 Minor
Groundwater	Pollution from accidental spills from materials handling	Direct	High	Medium	12 Major	Low	Low	4 Minor
Groundwater	Pollution from waste generated during vehicle maintenance	Direct	High	Medium	12 Major	Low	Low	4 Minor
Groundwater	Pollution from domestic waste disposal	Direct	Medium	Medium	9 Moderate	Low	Low	4 Minor
Groundwater	Pollution from drill wastes - management and disposal	Direct	Medium	Medium	9 Moderate	Low	Medium	6 Moderate
Groundwater	Pollution from well blow-out	Direct	High	High	16 Major	Medium	Medium	9 Moderate





6.3 Operational Phase Impacts

The operational phase of the Kingfisher project will include a number of activities that could potentially impact on the groundwater resources. The Project surface facilities shall cover the Kingfisher production and transmission system from outlet of the well Christmas choke valves; to inlet flange of delivery point and include the following elements:

- Operational Well pads;
- Flowlines;
- Central Process Facilities (CPF);
- Crude oil Pipeline;
- Lake Water Extracting Station; and
- Infrastructure (camps, roads, buildings, etc.).

The well-fluids from the Kingfisher field will be sent to a CPF on the Buhuka flats. In general, the CPF will comprise the following activities and areas:

- Oil Separation Flash Gas facilities
- Gas Treatment & Compression facilities
- Produced Water Treatment & Injection facilities
- Oil Storage & Export facilities
- Ground flare
- Power Generation plant
- Electrical substation
- Water treatment plant
- Fire water and pumps
- Plant Utilities area
- Control room and administrative buildings
- Maintenance workshop
- Gatehouse
- Perimeter fencing, lighting and internal access road system

The well-fluids will be processed in the CPF to separate formation water and associated gas from the oil phase. The oil will be stabilized, desalted, and dehydrated to meet the export specification of oil.

Associated gas will be separated at the CPF and utilized in priority for field requirements such as fuel gas for power generation, heating system and other utilities.

Produced water from separators is required to be treated in three stages of separation to achieve the injection water specifications. Produced water along with treated lake water from the CPF will be injected into the reservoir. Lake water will be pumped to the CPF via a dedicated flow line running from the Lake Albert intake facilities.



After well completion, the rig and the auxiliary facilities will be removed, and feeder field pipeline will be installed to conduit the crude from the well to CPF. Some minor adjustments in the well configuration design may be adopted to factor in the infrastructural changes. Normally, each well pad comprises:

- Production well heads and manifolds
- Water injection wells and manifolds (described in more detail in Section xx);
- Utility Systems;
- Production and test flow meters;
- Pig Launcher/Receiver;
- Chemical injection system;
- Closed drain system; and
- Equipment room to accommodate instrumentation, telecom, and electrical equipment etc.

The well pads will be security fenced, with a 24-hour security guard, but will not otherwise be manned. All normal monitoring and operational requirements will be managed from the CPF control room.

A production manifold shall be installed at each well site to gather produced fluids from the production choke valve on each Christmas tree (well head) via the individual well flowline. A test manifold shall also be provided to allow well testing to occur without interrupting production. The individual well flowlines shall be provided with manual block valves to divert produced fluids from production to test manifolds.

A water injection manifold shall be installed at each well site to deliver high pressure water for injection to the water injection choke valve on the Christmas tree via individual well flowlines. The individual well flowlines shall be provided with a manual block valve and a flowmeter.

The well-fluids (mixture of gas, crude and water, etc.) from the Kingfisher Field will be sent to the CPF (as described above) via infield flowlines from individual well pads. All individual well flowlines and manifolds shall be heat traced and insulated for heat conservation. Its design shall allow for drilling rig to move between different slots without shutting down production from the well pad. The well pads are designed as normally unmanned. Firefighting philosophy will also be defined for drilling and completion operations and workover operations and normal production on the well pads.

A buried crude oil pipeline about 50km long with a width of approximately 12"~14" (and requiring a servitude of approximately 30m) with Block Valve Station (BVS) on the escarpment is proposed for the oil export from CPF to the delivery point. Electricity shall be generated at the Kingfisher CPF. A high voltage transmission cable (buried and installed in the same trench as the oil export pipeline) routes from Kingfisher CPF to Kingfisher Block Valve Station and on to Kabaale, with connections to each intermediate heating station and isolating block valve station along the route of the export pipeline. Each connection shall include a local transformer and switchgear.

6.3.1 Generation of domestic waste water discharge

The permanent operators' accommodation Camp (production camp) would be sized for around 220 personnel (approximately 200m x 150m) and would include operational, maintenance, support, security and Well Workover personnel.

The planned capacity of the domestic sewage treatment plant is 45 m³/day, making provision for an estimated 135 personnel plus contingency. Treated sewage effluent will meet the more stringent of the Ugandan and IFC treated sewage effluent requirements. The sewage treatment plant will be located at the permanent camp. Backup sewage treatment capability will be provided by the sewage treatment plant built to supply the drilling camp, which has spare capacity for an additional 90 people. The two sewage plants will be linked to allow for maintenance shutdowns of either plant. After drilling is completed in year 6, the drilling sewage plant will be maintained as a backup.



Sewage from the CPF will be routed via conservancy tanks to a regulating tank at the permanent camp from where it will be treated in a Membrane Bioreactor sewage treatment works.

Options for final disposal of treated sewage effluent include the base case (discharge into perimeter drains around the CPF, which discharge into small drainage lines leading to Lake Albert), irrigation onto land in the buffer area around the CPF and at the personnel camp lawns and gardens, discharge into an artificial wetland and other possibilities to be considered in the ESIA. Injection with produced water is not feasible due to the risk of bacterial contamination in the reinjection wells.

There may be potential for groundwater pollution as a result of spillages and malfunctioning of the WWTP system, as well as from seepage from drains, which can lead to shallow groundwater pollution. The impact for this activity which is the potential for groundwater pollution is rated at **moderate** (9) before mitigation, because of the medium sensitivity and magnitude of the impact expected without mitigation.

Mitigation measures include adequate design of the WWTP and management to handle the expected volumes of effluent and treated effluent discharge. Downstream groundwater monitoring of the systems is recommended especially in the case where groundwater may be used for domestic supply. Post mitigation the impact will be **minor** (4).

6.3.2 Solid Waste Generation

Domestic waste generation is common to both the construction and operational phase. As discussed in section 6.2.6 above, the influx of workers on the flats will generate domestic waste at the residential and operational areas. Waste will typically comprise of food packaging, food waste, plastic bags and bottles, etc. A formal waste management plan that includes re-use and recycling will be required to reduce the impact from this activity on the groundwater source and a formal waste handling/disposal site will have to be developed.

The Project will comply with the Ugandan National Environment (Waste Management) Regulations, S.I. No 52/1999. Reference will also be made the OGP (International Association of Oil & Gas Producers), Guidelines for Waste Management with special focus on areas with limited infrastructure (updated March 2009) as a best practice reference.

The management of solid wastes generated at the CPF is described below. Further details of solid waste management are provided in the CNOOC Waste Management Philosophy (KF-FS-RPT-CPF-SA-0002) and in the Waste Management specialist study undertaken as a part of the ESIA.

The Ugandan Waste Management Regulations prohibit the 'treatment' of petroleum waste by the operator.

CNOOC's Waste Management Design Philosophy (2016) commits the company to comply with the key principles underpinning the waste hierarchy, which are, wherever possible, to avoid or reduce the generation of waste (or waste toxicity) at source, and/or to re-use or recycle the waste, before considering disposal options. This philosophy is also enshrined in the Ugandan Waste Management Regulations and in most international waste management standards and guidelines, including those of the IFC/World Bank.

Wastes will be segregated and stored temporarily at designated Waste Collection Points (WCPs) which will operate at the CPF. The WCPs will typically comprise of concrete hardstands, storage containers, secondary containment for hazardous liquid wastes (oil etc.), and provisions to prevent ingress of rain and sunlight, as well as protection measures from fire. Space will be reserved for separate storage containers to store prime recyclables (paper, cardboard, scrap, metal), domestic waste and hazardous waste which require segregation. A Waste Storage Area (WSA) will be determined as the central collection area for all stored waste generated at the CPF and as the transit station for collection by waste contractors for disposal.

Waste streams will be divided into three broad groups:

- recyclable / recoverable;
- general (non-hazardous); and



- hazardous.

Waste will be segregated at source. Once the waste is segregated, the labelled containers will be stored in the WCP area with secondary containment, where necessary. The waste management area will be concrete floored, bunded and roofed to prevent rainfall ingress. The temporary storage area for hazardous wastes will be secured to prevent unauthorized access.

Hazardous waste materials will be generated during the operation phase ranging from used solvents, used oil and grease, etc. The magnitude of the groundwater impact of the generation of waste before mitigation is expected to be **major** (12). After the implementation of mitigation measures, such as the waste management plan, the magnitude can further be reduced to **moderate** (6) and the potential impact will be of short term and limited to the directly affected site.

6.3.3 Accidental spills of materials stored and handled

The design will provide for secondary containment around storage tanks of hazardous liquids, so as to minimize the risk of spillages due to accidents or leaks. Secondary containment shall consist of berms, dykes or walls capable of containing the larger of 110% of the largest tank or 25% of the combined tank volumes in areas with above-ground tanks with a total storage volume equal to or greater than 1,000 litres and will be made of impervious, chemically resistant material.

It is expected that large volumes of potential hazardous materials will be stored and handled at the CPF site. The risk for a spill has to be considered as a potential impact. The magnitude of the impact is considered to be **major** (16) before mitigation measures are adopted. Mitigation of these types of impacts will include the setup of site specific risk assessments and materials handling procedures by construction workers. All workers should be made aware of the risks associated with handling these hazardous materials and spill prevention and clean-up measures. With these applied mitigation measures the impact on the groundwater can be reduced to **moderate** (8).

6.3.4 Waste generated during flow line and CPF maintenance activities

Operational activities consider routine maintenance such as welding, pigging of flowlines and, testing. Impacts are spillages of solid or pigging waste or, of hydro-test water. Potentially hydrocarbon contaminated drainage including pigging waste need to be collected in sumps for drumming and disposal at the CPF. The drums should be protected from rain water ingress. Hydro-testing should be carried out with a minimum of chemical additives and hydro-test water will be kept in lined ponds until tested and if necessary treated to remove contaminants prior to release through distribution to the surrounding environment. Adopting the correct mitigation measures reduces the magnitude of the impact from **moderate** (9) to **moderate** (6).

6.3.5 Inadequate drainage/stormwater management

Potentially Oil Contaminated (POC) stormwater generated in the defined hazardous areas of the plant will be collected in the open drain system for delivery to an API oil separator. API separators are designed to separate gross amounts of oil and suspended solids from the water. The first 15 minutes of any storm will be captured and routed through the API separator before being delivered to the secondary treatment section of the produced water treatment system for further treatment and disposal with produced water. A maximum 15-minute stormwater runoff value of 120 m³ (equivalent to runoff of 478 m³/hr) is provided for. The balance of any stormwater will be captured in a stormwater pond, tested and released into the environment, if it meets the discharge specification. All stormwater from designated non-hazardous areas of the plant will be released directly from the open drains, without testing.

The design and application of drainage/stormwater management ensures that contamination of groundwater and other receptors is avoided. The system will require permanent maintenance in order to ensure it has the capacity to handle the required volumes. A potential impact is associated with the failure of the drainage system to function to its capacity. The magnitude of the impact is determined to be **moderate** (9) after mitigation, which should include upgrading and continually managing the drainage systems on site, the magnitude is lowered to **minor** (3).



6.3.6 Production Waste Generated on the Well pad

In order to handle oily drainage from pipelines and equipment, each well pad will be provided with an underground closed drain system leading to a sump with a submersible pump. The levels will be monitored and the sump periodically emptied into a mobile tanker for handling at the CPF.

Only small quantities of solid waste will be generated, once drilling is completed. The wells are unmanned and will be remotely operated from the CPF over extended periods, without intervention on the well pad. During maintenance, small quantities of potentially oil contaminated and non-hazardous waste will be generated. These will be separated into non-hazardous and hazardous components, delivered to the CPF for temporary storage and then recycled, where possible, or earmarked for disposal by a certified hazardous waste contractor. CNOOC indicates that NORM is not expected in the pigging wastes. Estimated quantities of potentially hazardous waste are less than 0.5 t/well/year.

Management and mitigation can reduce the potential impact on the groundwater from these waste sources from an impact rating of **moderate** (9) to **minor** (4).

6.3.7 Produced Water Injection

Discharge of produced water outside the boundary of the production facilities will not be considered owing to the sensitivity of the receiving environment. Produced water will be treated to meet the injection water specification, combined with lake water to make up the required quantity, and injected back into the oil reservoir to maintain reservoir pressures. Produced water will increase sharply in the first few years of the project while ramping up to full production in year 6 (415 m³/h). The steep annual increase continues until around year 11 (679 m³/h) after which the curve flattens, and from year 17 onward annual increases in produced water generation are slight. At year 25 end-of-life of the field, produced water reaches a peak of 756 m³/h.

Injection water will consist of a combination of produced water, water from POC areas at the CPF and make up water from Lake Albert. All injection water will be treated to meet the injection water specification. The stringent requirement to remove oil from the produced water (Table 15) is mainly to prevent clogging of the injection system. The produced water stripped from the oil in the primary and secondary separators will be delivered to the water treatment plant for further cleaning.

Table 15: Specification for injection of produced water

Specification	Unit	Value
Suspended Solids	mg/l	< 5.0
Particle Size	mm	< 3.0
Oil cut	mg/l	< 15.0
Average corrosion rate	mm/a	<0.076
Dissolved Oxygen	mg/l	0.1
Sulphate Reducing Bacteria	unit/ml	25
Ferrobacteria	unit/ml	< n X 10 ³ (1<n<10)
Metatrophic bacteria	unit/ml	< n X 10 ³ (1<n<10)

The produced water treatment plant will consist of three treatment stages: primary, secondary and tertiary. The specification for produced water quality is stringent, and the basis of design requires a multi staged produced water treatment plant, comprising primary, secondary and tertiary treatment. A number of options have been considered for each stage.

Maximum water injection pressure will be 199.8 bar (a typical car tyre is pressurised to around 2.5 bar). Pressure will be provided by pumps located at the CPF. Produced water injection temperature at the well head will be 75°C. Produced water will be heated at the CPF and transmitted along the injection flowlines to





the injector wells. Sixty three percent of the oilfield thermal load (heating requirement) will be for produced water injection, the balance being heating required for maintenance of minimum required oil temperatures. Injection of chemical additives at the well pad will not be required. A wide variety of additives will be required but these will be injected in different areas of the produced water circuit at the CPF, prior to delivery to the wells. CNOOC proposes to test polymer flooding after first oil, which is a method of adding a polymer to the injection water that increases its viscosity and improves oil recovery performance from the reservoir.

There are various chemical constituents that could be present in the Produced water. These chemicals, individually or collectively, could have significant impact on the environment if releases through accidents, leakage from the wells, or spillages. The severity of an uncontrolled release of produced water impact is therefore rated as **major** (16) but can be reduced to **moderate** (9) after mitigation.

6.3.8 Pipeline or Flowline Failure

The processes utilised at the CPF and pipelines are complex and, in many instances, involve high pressures. Potential failures of materials and equipment could result in the accidental release of hazardous materials and severe groundwater pollution if not brought under control. The main pipeline to Kabaale will follow a route through several communities that are dependent on groundwater as the main water supply. The associated impact is therefore determined as **major** (16) before mitigation. Mitigation will involve hazardous materials management plan including: equipment audits, flow line testing, inspections programs; as well as application of Standard Operating Procedures (SOPs). The probability of such an event taking place over the life time of the plant and pipeline is high before the mitigation but the impact rating is lowered to **moderate** (9) following mitigation.

6.3.9 Well Failure or Blow-out

A well blow-out is the uncontrolled release of crude oil from a well, resulting in the release of hydrocarbons, water-based mud and/or water. Blow-outs can occur during exploration or development drilling. They can also occur in the production stage, for instance during maintenance work on a well or due to escalation of a collision or a fire or explosion on the platform. The risk of a blow-out is minimal and not all blow-outs have significant environmental impacts. A blow-out will last until the well is under control again. This may take anywhere from a few hours if control can be regained using the safety systems, up to several months if an additional well needs to be drilled to regain control over the first well. Experience has shown that control over wells can be regained in one or a few days if a blow-out should occur.

The crude oil mixture released during a blow-out, will have a detrimental effect on groundwater systems if not brought under control timeously; and is potentially the most severe and long-term environmental impact associated with oil and gas projects. However, blow out incidents are limited by the use of technology advances in drilling techniques and fluid management. The impact is listed here as **Major** (16) based on the potential to cause detrimental damage to aquifers and other water sources in the case of a blow-out. The mitigation measures reduce the impact to **moderate** (9) based on the low likelihood of such an incident occurring.



GROUNDWATER SPECIALIST STUDY

Table 16: Operation Phase Impacts

Receptor	Description	Type of Impact	Pre-mitigation			Post-mitigation		
			Sensitivity	Magnitude of Impact	Impact Severity	Sensitivity	Magnitude of Impact	Impact Severity
Groundwater	Pollution from domestic waste water discharge	Direct	Medium	Medium	9 Moderate	Low	Low	4 Minor
Groundwater	Pollution from accidental spills from materials handling	Direct	High	High	16 Major	High	Low	8 Moderate
Groundwater	Pollution from waste generated during flow line and CPF maintenance activities	Direct	Medium	Medium	9 Moderate	Medium	Low	6 Moderate
Groundwater	Inadequate drainage/stormwater management	Indirect	Medium	Medium	9 Moderate	Medium	Very Low	3 Minor
Groundwater	Pollution from solid waste generation	Direct	High	Medium	12 Major	Medium	Low	6 Moderate
Groundwater	Production Waste Generated on the Well pad	Direct	Medium	Medium	9 Moderate	Low	Low	4 Minor
Groundwater	Pollution from Produced Water Injection	Direct	High	High	16 Major	Medium	Medium	9 Moderate
Groundwater	Pollution from pipeline/flowline failure	Direct	High	High	16 Major	Medium	Medium	9 Moderate





GROUNDWATER SPECIALIST STUDY

Receptor	Description	Type of Impact	Pre-mitigation			Post-mitigation		
			Sensitivity	Magnitude of Impact	Impact Severity	Sensitivity	Magnitude of Impact	Impact Severity
Groundwater	Pollution from well blow-out	Direct	High	High	16 Major	Medium	Medium	9 Moderate



6.4 Cumulative Impacts

Cumulative impacts can be described as the impacts on the environment that results from the incremental impact of the action when added to other past, present, and reasonably foreseeable future activities at a project site. Cumulative impacts can therefore result from individually minor but collectively significant actions taking place over a period of time.

All the “past, present, and future activities” associated with the oil field development in the Albertine Graben is located outside of the Kingfisher and Block EA 3A areas operated by CNOOC. The potential groundwater impacts discussed and identified in the previous sections related to materials, waste, and effluent handling. The groundwater pollution resulting from these activities will be localised to the site of occurrence and will affect the resource (groundwater and surface water) directly downstream. It is not foreseen that the impacts will be affecting the resources in an area more than 1km from the impact site – unless in the case of an unlikely catastrophic well blow out or pipeline failure.

It is therefore concluded that there will be *no cumulative impacts on the groundwater resource* as a result of adjacent oil field development

6.5 Residual impacts

Residual impacts on groundwater would depend on the success of implementation of mitigation measures to prevent the contamination of groundwater resources by activities of all phases of the project lifecycle. Ongoing groundwater monitoring would indicate if residual impacts could occur and should be managed accordingly.

7.0 MITIGATION MEASURES

7.1 Construction Phase Mitigation

Performance Standard 1 of the IFC Standards (Assessment and Management of Social and Environmental Risks) establishes the overarching process of managing social and environmental risks and impacts throughout the life of the project. The major objectives are to identify and evaluate these social and environmental risks; to adopt a mitigation hierarchy that responds to these risks; to ensure communications with external stakeholders are appropriately managed and promoted; and to provide a means for the adequate engagement of affected communities. All mitigation measures discussed here thus takes cognisance of the IFC Standards, together with the relevant Ugandan legislative requirements, CNOOC’s in-house environmental specifications and acceptable industry best practice.

The impacts expected on groundwater resources are discussed in the previous sections touched on mitigation measures that could be applied to minimise the impacts and reduce impact severity. Impacts are mostly related to waste water and solid waste generation during the construction phase and mitigation measures typically consist of management plans to handle hazardous materials, waste and waste water to reduce the impacts.

Sewage waste from workers camps etc. should be treated and disposed of in accordance with (i) the National Environment (Standards for Discharge of Effluent into Water or on Land) Regulations, S.I. No 5/1999; (ii) The IFC General EHS Guidelines for environmental Waste water and ambient water ; and (iii) the Company requirements as stated in Water Management Specification (2148-QHSE) Table 20:

Table 17: Standards for Discharge of Effluent

Parameter	Unit	Uganda	IFC	Company requirement
pH	pH	6 – 8	6 – 9	6 – 8
BOD	mg/l	50	30	30
COD	mg/l	100	125	100





Parameter	Unit	Uganda	IFC	Company requirement
Total nitrogen	mg/l	10	10	10
Total phosphorus	mg/l	10	2	2
Oil and grease	mg/l	10	10	10
Total suspended solids	mg/l	100	50	50

CNOOC's Waste Management Design Philosophy (2016) commits the company to comply with the key principles underpinning the waste hierarchy, which are, wherever possible, to avoid or reduce the generation of waste (or waste toxicity) at source, and/or to re-use or recycle the waste, before considering disposal options. This philosophy is also enshrined in the Ugandan Waste Management Regulations and in most international waste management standards and guidelines, including those of the IFC/World Bank.

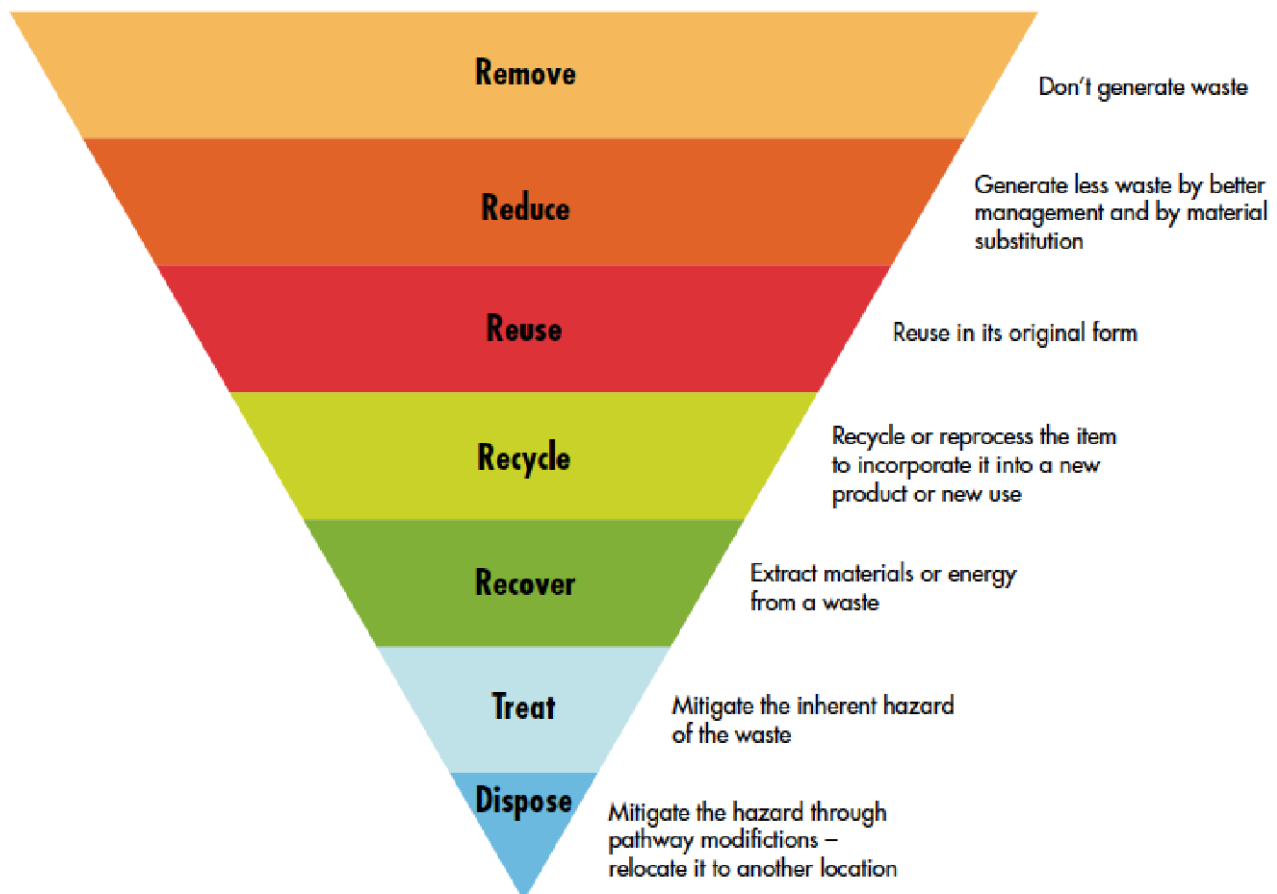

Figure 12: The solid waste management hierarchy

Wastes will be segregated and stored temporarily at designated Waste Collection Points (WCPs) which will operate at the CPF. The WCPs will typically comprise of concrete hardstands, storage containers, secondary containment for hazardous liquid wastes (oil etc), and provisions to prevent ingress of rain and sunlight, as well as protection measures from fire. Space will be reserved for separate storage containers to store prime recyclables (paper, cardboard, scrap, metal), domestic waste and hazardous waste which require



segregation. A Waste Storage Area (WSA) will be determined as the central collection area for all stored waste generated at the CPF and as the transit station for collection by waste contractors for disposal.

Groundwater monitoring wells should be installed up and down-stream from any waste disposal and or storage areas. These monitoring wells should form part of the overall groundwater monitoring programme of the Project. Similarly, if the waste discharge effluent disposal is done by means of subsurface drains, these facilities should be monitored through installation of downstream monitoring wells.

Table 18 describes the waste streams, estimated quantities and disposal options for drilling and other wastes from the well pad during the drilling of wells (further details and hazard classification are to be provided in the Waste impact study undertaken for the ESIA). CNOOC will meet the requirements of the Ugandan National Environment (Waste Management) Regulations, S.I. No 52/1999. Where specific Ugandan environmental standards are not available, international guidelines will apply. In particular, CNOOC waste management practices will be aligned with the International Association of Oil and Gas Producers (OGP) guidelines as a measure of international best practice (OGP, 2008: Guidelines for Waste Management with Special Focus on Areas with Limited Infrastructure. Report 413, Rev. 1.1; and with IFC Health and Safety Guidelines for Onshore Oil and Gas Development, April 4th, 2017).

The bulk of the waste generated on the well pads will consist of drilling cuttings and clear liquids. While there will be some variability between the wells, and the quantity of drilling waste will depend on final decisions about dewatering equipment, typical cuttings volumes will be in the order of 600 m³/well, with one third water based mud cuttings and the balance synthetic mud cuttings. Liquids for disposal are expected to be in the order of 1,000 m³ per well, dependent on how much is evaporated from the evaporation ponds.



Table 18: Wastes generated on the Kingfisher well pads during the drilling phase

Waste Stream	Estimated quantity (total per well)	Waste Management Options
Hazardous Solids (used chemical containers, fuel storage containers, oil-contaminated rags, used batteries, used filters, fluorescent tubes, power unit/transport maintenance wastes, paint waste,)	0.1 t	Options include recovery / recycling, disposal (with or without pre-treatment) to landfill licensed to receive hazardous waste.
Hazardous solids (potentially contaminated cement slurry)	4 t	Disposed to landfill licensed to receive hazardous waste.
Hazardous Liquids (used oil, waste chemicals, rinsate, thinners, viscofiers, solvents, acids, treating chemicals, other used chemicals in drums)	0.07 t	Options include recovery / recycling, disposal (with or without pre-treatment) to landfill licensed to receive hazardous waste.
Non Hazardous Liquids (sewage effluent, grey water)		Conservancy tanks. Domestic effluent removed by tanker to the sewage treatment plant at the drilling camp
Non Hazardous Solids (construction materials, packaging wastes, paper, scrap metal, plastics, glass)		Waste minimization, separation, re-use and recycling where possible. Domestic refuse disposed to landfill licensed to receive domestic waste.
Drilling Cuttings (solids), coarse and fine particles - aqueous (water based)	205 m ³	Separation from drilling fluids in varying degrees, depending on dewatering equipment installed on the well pad. Disposal to landfill licensed to receive the waste by a certified waste contractor. Landfill site options to be assessed in the ESIA. Landfills include: <ol style="list-style-type: none"> 1. Enviroserv Uganda Ltd. 2. White Nile Consultants Ltd. 3. ??
Drilling Cuttings (solids), coarse and fine particles - synthetic	402 m ³	
Drilling Liquids (including clear liquids from dewatering of aqueous drill cuttings)	500 m ³	Recycled as much as possible. May also be reduced by evaporation ponds. Disposal to landfill licensed to receive the waste. Quantity will depend on extent of evaporation in evaporation ponds. Landfill site options to be assessed in the ESIA (see above).
Completion Fluids (solids, residual drilling fluids, hydrocarbons, acids, glycol, methanol, other)		Pre-treatment and/or disposal to landfill licensed to receive the waste. Preferred landfill site to be determined by the ESIA (see above).

Note: there will be a total of 31 wells drilled (production and injection) in 5 years

Figure 13 provides an organogram of a typical drilling circuit, showing the two main waste streams (cuttings and clear liquids). Quantities are estimates and will depend on a number of factors, including the extent to which dewatering equipment is used on site and liquids are recycled. A rule of thumb is roughly 0,5 m³ of drilling mud per metre of well drilled.

The drilling waste management system will operate in a ‘Zero discharge’ principle. Facilities will always be available to deal with discharge requirements and react quickly to changing conditions. The main principle is





solid-liquid separation and water-oil separation, solid, water process. Typical drilling waste process and recycle flow chart is shown in Figure 13.

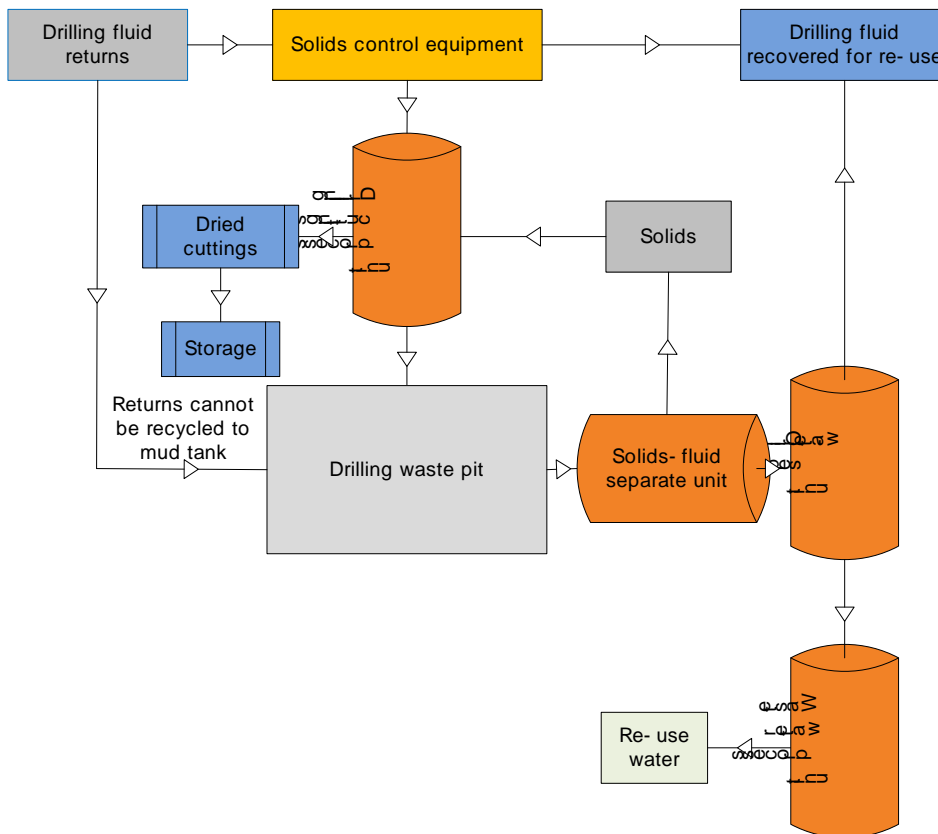

Figure 13: Drilling waste process and recycle flow chart.

On the rig site drilling fluid that returns from the drill hole will be transferred to solid control equipment for primary processing. The fluid will be recovered for re-use and the cuttings will be transferred to the drilling cuttings process unit for secondary processing. The majority of drill cuttings will be processed to dried cuttings with oil content below 5%. These cuttings will be stored in specific containers. The remaining fluid and tiny solid particles will be discharged to the drilling waste pit. Returned drilling fluid that cannot be recycled to the mud tank (such as waste fluid after cementing) will be discharged to the drilling waste pit. These wastes will be pumped to the solids-fluid separate unit for separating. Solids will be transferred to the drilling cuttings process unit for further processing and the fluid will be transferred to the oil-water separator (to recover oil for re-use), and the waste water processing unit (to recover water for re-use).

If drill cuttings will be stored and/or disposed in pits, the following mitigation measures must apply:

- Pits should be lined and tested for integrity prior to use;
- Bottom of pits should be higher than 5 m above the seasonal high water table;
- Prevention of natural surface drainage entering the pits during rains;
- Installation of a perimeter fence around the pits or installation of a screen to prevent access by wildlife (including birds), livestock, and people;
- Pit closure should be completed as soon as practical, but no longer than 12 months, after the end of operations; and
- If the drilling waste is to be buried, the Mix-Bury-Cover disposal method should be used.





The drilling fluid is the primary safeguard against blow-out of hydrocarbons from a well and its density can be controlled to balance any anticipated formation pressures. The drilling mud will be tested from time-to-time during the drilling process and its composition adjusted to account for any changing down-hole conditions. The mud density will be adjusted as required by an on-site chemist. The likelihood of a blow-out will be further minimized by using a specially designed blow-out preventer (BOP). When installed on top of the well-bore, a BOP will close the well automatically in case of a blowout.

The most important mitigation measure for potential impacts to groundwater will be monitoring of the groundwater systems. This will only be accomplished by installation of dedicated groundwater monitoring wells. The monitoring network should be concentrated at the KP area and should include community wells. The installation of the network should be done during the construction phase of the project.

The spatial distribution, depth, and construction of the wells will be dependent on the identified waste sources and final infrastructure distribution. The monitoring system needs to be designed to monitor all identified potential sources of groundwater contamination on the Kingfisher Project area (CPF, well pads, flow lines and accommodation camps). This will ideally include the installation of monitoring wells up- and down-gradient of all activities/sources that could result in potential groundwater pollution. Frequencies of sampling and required analytical parameters need to be discussed with the relevant Regulatory Authority. It is recommended, based on similar project experience, to sample wells quarterly, and to analyse for all the parameters included in the hydrochemical evaluation of this report (See Section 5.4.3).



Table 19: Mitigation Summary - Construction Phase

Groundwater Impacts During Construction Phase				
Management Objectives: Protect groundwater resource				
Overall Significance before mitigation: Major/Moderate				
Overall Significance after mitigation: Minor				
Mitigation Measures	Monitoring Indicators	Monitoring Frequency	Responsible Entity	Training Necessary
Design waste water discharge systems according to the volumes expected based on the number of workers on site and to allow adequate draining, to avoid any flooding	Flow volumes	Monthly	CNOOC	
Provision of portable toilets along construction routes (pipeline) and at the well pads.	Maintenance and disposal of effluent	Weekly	CNOOC and Contractors	
Waste Management Plan	Waste management regulations		CNOOC	
Installation of groundwater monitoring boreholes and water sampling	As required by Regulatory Authority	Quarterly	CNOOC	Microbial indicators need to be done on-site
Monitoring of effluent discharge	As per effluent discharge regulations (Table 20)	Monthly	CNOOC	Microbial indicators need to be done on-site
Drilling fluid testing and installation of blow-out preventer	Drilling mud properties and pressure testing	Daily?	CNOOC	

7.2 Operational Phase Mitigation

During operation of the Project there will be many mitigation and monitoring measures that will be required to minimise any potential impacts from the Project sites.

The most important mitigation measure for the protection of the groundwater systems will be the ongoing monitoring of groundwater with the monitoring programme established during the Construction phase of the project (see previous Section). Monitoring of the groundwater at the CPF, well pads and local communities on the Buhuka Flats needs to take precedence.

Leak detection and regular testing of the pipeline will be part of the operational procedures for the pipeline, and therefore the installation of monitoring wells along the pipeline should not be required, unless an incident occurs along the route. It is however, recommended that the local community wells less than 1km from the pipeline need to be considered as part of the monitoring programme.





Pipeline failures can be prevented by choosing the right materials suited to the product transported, equipment and appropriate maintenance and testing of the pipeline. Hydrostatic testing by which the pipeline is subjected to pressure above the operating pressure, to blow out defects before they reach a critical size in service should also be used to detect corroded pipe before it fails in service. A pipeline integrity strategy should be compiled; to guide inspection and preventive maintenance to ensure the integrity of the pipeline. In order to prevent a catastrophic pipeline failure, a management plan should be developed and measures put in place to clean-up soils and groundwater.

Stormwater management should be done in accordance with the recommendations in the surface water specialist report to prevent potential groundwater pollution. Storm water should be separated from process and sanitary wastewater streams wherever possible in order to reduce the volume of wastewater to be treated prior to discharge. Storm water from clean areas such as building roofs or roads shall be allowed to soak-away or be reused as a resource where possible. Good engineering practice need to be employed in the drainage design to ensure that contamination of water and waste by undesirable elements (e.g. oil and heavy metals) is kept to a minimum, and below legislated requirements.

A 'hazardous area open drains' system should be designed to collect water run-off (storm water, fire water, wash-down and any chemical spillages) from hazardous paved areas that are not normally contaminated by hydrocarbons, and hydrocarbon contaminated oily water from designated hazardous areas. The oily water collection system which gathers the above mentioned drainage can be through buried pipes with first flush sumps connected to oil-water interceptors. Storm water runoff should be treated through an oil/water separation system to achieve an oil & grease concentration of <10 mg/L.

To control leaks from storage tanks, secondary containment must be used in the design of the facilities to control the accidental release of liquids to the environment. Secondary containment shall consist of berms, dykes or walls capable of containing 110 percent of the largest tank or 25 % of an areas combined tank volume (i.e. where above-ground tanks have a total storage volume => 1,000 litres). Such structures must be made of impervious, chemically resistant material.

Necessary measures must be considered and provided to prevent oil spillage and discharge of site If discharge of site is needed, it should be treated to meet the discharge limits and the oil concentration must be less than 10 mg/L.

Sewage waste from the Permanent workers camp and CPF should be treated and disposed of in accordance with (i) the National Environment (Standards for Discharge of Effluent into Water or on Land) Regulations, S.I. No 5/1999; (ii) The IFC General EHS Guidelines for environmental Waste water and ambient water ; and (iii) the Company requirements as stated in Water Management Specification (2148-QHSE) and shown in Table 20 below:

Table 20: Standards for Discharge of Effluent

Parameter	Unit	Uganda	IFC	Company requirement
pH	pH	6 – 8	6 – 9	6 – 8
BOD	mg/l	50	30	30
COD	mg/l	100	125	100
Total nitrogen	mg/l	10	10	10
Total phosphorus	mg/l	10	2	2
Oil and grease	mg/l	10	10	10
Total suspended solids	mg/l	100	50	50



The Project should comply with the Ugandan National Environment (Waste Management) Regulations, S.I. No 52/1999. Reference will also be made the OGP (International Association of Oil & Gas Producers), Guidelines for Waste Management with special focus on areas with limited infrastructures (updated March 2009) as indicators of best international practice. See KF-FS-RPT-CPF-SA-0002 Waste Management Philosophy for more details.

Waste will be segregated at source. Once the waste is segregated, the labelled containers will be stored in the WCP area with secondary containment, where necessary. The waste management area will be concrete floored, bunded and roofed to prevent rainfall ingress. The temporary storage area for hazardous wastes will be secured to prevent unauthorized access.

A description of typical wastes and their quantities expected at the CPF is included in Table 21.

Table 21: Hazardous production wastes generated at the CPF during the operational phase

Waste Type	Activity / Source	Potential Contaminants	Mass per year (t)
Contaminated soil/hydrocarbon bearing soil	Spill/leaks	Hydrocarbons, heavy metals, salts, treating chemicals	5 t
Pigging sludge	Pipeline cleaning operations	Hydrocarbons, solids, production chemicals, phenols, aromatics	10 t
Waste oil sludge (from produced water treatment)	Produced water treatment system	Hydrocarbons	200 t
Produced sand	Removal from well fluids	Hydrocarbons	145 t
Pipe scale, hydrocarbon solids, hydrates, and other deposits	Cleaning piping and equipment	Hydrocarbons, heavy metals	20 t
Solid wastes generated by crude oil and tank bottom reclaimers	Separation tank sediments	Hydrocarbons, solids, production chemicals, phenols, aromatics	5 t
Empty chemical drums, drum rinsate and containers	Chemical injection, water treatment, cleaning agents	Heavy hydrocarbons, solvent	65 t
Cement slurries	Cement slurries	Heavy metals, thinners, viscosifiers, pH, salts	5 t
Paint materials	Unused paints, used thinners	Heavy metals, solvent, hydrocarbons	0.5 t
Maintenance wastes	Sandblast (grits), greases, fuel oils, filters, paint scale	Heavy metals, hydrocarbons, solids, solvents	5 t
Industrial waste	Batteries, transformers, Capacitors	Acid, alkali, heavy metals, PCBs	3 t
Scrap metals	Used piping, cables, drums, casing etc.	Heavy metals, scales	2 t
Sewage sludge	Domestic water treatment	Pathogens	???

Table 22: Non-hazardous waste generated at the CPF during the operational phase (including wastes from the permanent camp)

Waste Type	Activity (Source)	Mass per year (t)	Recycling / Disposal
Plastic	Bottles, waste packings		Mostly recycled





Waste Type	Activity (Source)	Mass per year (t)	Recycling / Disposal
Paper / packaging	Packaging, office paper waste		Recycled
Wood	Packaging		Recycled
Rubber	Vehicle tyres		Recycled
Glass	Bottles		Recycled
Food and vegetable waste	Kitchens		Composted
Metal	Cold drink cans, processed food, other non-hazardous products, electrical metal scrap		Steel disposed to landfill. Aluminium recycled. Copper recycled
Miscellaneous	General office and personnel camp scrap		Disposed to landfill

As mentioned above, mitigation will involve a hazardous materials management plan encompassing: equipment audits, flow line testing, inspections programs; and application of Standard Operating Procedures (SOPs).

Pipeline failures can be prevented by choosing the right materials suited to the product transported, equipment and appropriate maintenance and testing of the pipeline. Hydrostatic testing by which the pipeline is subjected to pressure above the operating pressure, to blow out defects before they reach a critical size in service should also be used to detect corroded pipe before it fails in service. A pipeline integrity strategy should be compiled; to guide inspection and preventive maintenance to ensure the integrity of the pipeline

The drilling fluid is the primary safeguard against blow-out of hydrocarbons from a well and its density can be controlled to balance any anticipated formation pressures. The drilling mud will be tested from time-to-time during the drilling process and its composition adjusted to account for any changing down-hole conditions. The mud density will be adjusted as required by an on-site chemist. The likelihood of a blow-out will be further minimized by using a specially designed blow-out preventer (BOP). When installed on top of the well-bore, a BOP will close the well automatically in case of a blowout.

A management plan needs to be in place in case of a catastrophic well blow-out and or pipeline failure. Such a management plan needs to include measures to clean-up soils and groundwater.



Table 23: Mitigation Summary - Operation Phase

Groundwater Impacts During Operation Phase				
Management Objectives: Protect groundwater resource				
Overall Significance before mitigation: Major/Moderate				
Overall Significance after mitigation: Minor/Moderate				
Mitigation Measures	Monitoring Indicators	Monitoring Frequency	Responsible Entity	Training Necessary
Design and installation of groundwater monitoring network	Water quality parameters	Monthly/quarterly	CNOOC	Microbial indicators need to be done on-site
Design waste water treatment systems according to the volumes expected based on the number of workers on site and to allow adequate draining, to avoid any flooding	Flow volumes	Monthly	CNOOC	
Storm water drainage system, clean and dirty water separation				
Waste Management Plan	Waste management regulations		CNOOC	
Engineering design to prevent accidents and spillages at storage areas – Secondary containment			CNOOC	
Monitoring of waste water discharge	As require per regulations (Table 20)	Monthly	CNOOC	Microbial indicators need to be done on-site
Pipeline integrity strategy	Corrosion, leak detection, failure indicators	Weekly?	CNOOC	
Drilling fluid and blow-out preventer	Drilling mud properties and pressure testing	Daily?	CNOOC	
Management plan in case of catastrophic well blow-out and or pipeline failure	Groundwater parameters, clean-up standards		CNOOC	

8.0 CLOSURE

This report had the objectives of establishing a groundwater baseline and groundwater impact assessment for the CNOOC’s Uganda’s, Kingfisher Oil Field Development in the Albertine Rift Valley in Western Uganda.

The baseline was established through review of existing groundwater information, a field investigation that included an extensive hydrocensus and sampling of groundwater. The groundwater systems has been characterised based on aquifer properties and water quality.





It was established that at the Kingfisher Project site on the Buhuka flats the groundwater is not considered as a viable source of water supply. However, along the pipeline route and other lake front villages, groundwater from wells is the only supply of potable water for many communities. Therefore, the groundwater systems need to be considered as an important element of the environment that needs to be protected against any potential negative impacts.

Potential impacts and risk factors to the groundwater from the Project during the construction phase are mainly limited to materials handling in conjunction with waste water and solid waste management. Most of the impacts are rated as high or moderate, and in all cases can be reduced to minor through mitigation and management measures. Impacts related to the operational phase include construction impacts (i.e. materials handling, as well as waste water and solid waste management) but also extend to storage of liquid waste, solid waste, drainage, and storm water management, at the CPF and accommodation camps.

The potential impacts associated with oil well drilling and operation is relevant to both the construction and operational phases of the Project and poses the most severe risks to the groundwater systems. However, by utilising technology, monitoring and management measures the impacts can be reduced to minor in all cases. Pipeline failure can also result in severe negative impacts of the groundwater systems but can be mitigated and managed through comprehensive operational practices.

Groundwater monitoring networks need to be established to monitor all potential sources of pollution to groundwater at the CPF and well pads. Community wells should be included in the monitoring networks where infrastructure failure can pose a risk to the groundwater.

9.0 ASSUMPTIONS AND LIMITATIONS

Assumptions and limitations pertaining to the Groundwater study include:

- No dedicated monitoring groundwater wells were available for the study; all samples were taken from community wells.
- The lithological description of the aquifer formations are based on public available information and no ground truthing were done to confirm the lithology of the formations that will constitute the aquifers for the project site.
- The mitigation measures recommended for the waste, waste water, and stormwater management need to be read and applied together with the Waste and Surface Water Specialist study reports.
- There is limited evidence that the groundwater resource and the surface water bodies are linked, such that the groundwater and surface water interaction for the project area is assumed to be insignificant.



10.0 REFERENCES

- Atecama Consult (2013) Proposed Appraisal Drilling: Mpyo Field (south area) Environmental and Social Impact Statement
- AWE (2008) ESIA for Kingfisher-2 Onshore Oil Exploration Well in Bugoma, Hoima District.
- AWE (2008) ESIA of Kingfisher-3 Onshore Oil Exploration Well in Bugoma, Hoima District.
- CNOOC (2013) Injection water supply for the Kingfisher Development area
- CNOOC (2013) Kingfisher-4 Pre-Development Well ESIA
- CNOOC (2013) Lake Region Operations Management Specification - 2148-QHSE
- CNOOC (2013) Waste Management Specification - 2148-QHSE
- CNOOC (2013) Water Management Specification - 2148-QHSE
- CNOOC (2014) Introduction to the Kingfisher field Geological Background. Presentation by Ronald Kaggwa on 26/02/2014.
- Directorate of Water Development, Ministry of Water & Environment (2012) Albert Water Zone, hydrogeological map series
- Directorate of Water Resources Management, Ministry of Water & Environment (2010) Hoima District Domestic Water Supply Report
- Environmental Assessment Consult Ltd (2013) EIA for 2D Seismic testing Kingfisher Area
- Environmental Assessment Consult Ltd (2013) The Environmental Audit for the drilling operations of Kingfisher 1, 2 and 3
- GAA (2014) Groundwater Report, Environmental and Social Impact Assessment for Kingfisher Development Area, Hoima District, Uganda, Golder Associates Africa (Pty) Ltd Ref: 13615730-12963-14, July 2014
- Heritage Oil (2010) Structure and Stratigraphy of the Lake Albert Rift, East Africa: Observations from Seismic Reflection and Gravity Data
- International Finance Corporation (2007) General EHS Guidelines: Environmental Wastewater and ambient Water Quality. Available at <http://www.ifc.org>.
- International Finance Corporation (2007) Onshore Oil and Gas development. Retrieved 06 11, 2014, from Environmental, Health, and Safety (EHS) Guidelines. Available at <http://www.ifc.org>.
- International Finance Corporation (2012) IFC Performance Standards on Environmental and Social Sustainability. Available at <http://www.ifc.org>.
- RPS Energy (2006) HOG EIA_Drilling Kingfisher1 Block 3A
- Tobias Karp, Christopher A. Scholz, and Michael M. McGlue (2013) Proposed Appraisal Drilling: Mpyo Field (south area) Environmental and Social Impact Statement
- Total (2012) Report on the Environmental Baseline Exploration Area 2
- Uganda National Environmental Management Authority (1999) National Environment (Waste Management) Regulations
- Uganda National Environmental Management Authority (2010) Environmental sensitivity atlas for the Albertine Graben - 2nd edition. Kampala.



Uganda National Environmental Management Authority (2013) Strategic environmental assessment (sea) of oil and gas activities in the Albertine Graben, Uganda

WHO (2011) Guidelines for Drinking-water Quality. 4th Edition - Geneva: WHO Press.

GOLDER ASSOCIATES AFRICA (PTY) LTD.

Author: Dr Jennifer Pretorius Senior
ESIA and Groundwater Specialist
PhD Geohydrology; Msc. Geohydrology;
Bsc. Geohydrology
NEMA Registration: CC/EIA/147/15

Senior review: Gerhard van der Linde
Senior Hydrogeologist
Bsc (Hons) Geohydrology 1998; National
higher diploma – Geotechnology 1995



APPENDIX A

Chemical Analytical Results



Republic of Uganda

Form A

NATIONAL WATER QUALITY REFERENCE LABORATORY - ENTEBBE

Certificate of Analysis

Name of client : CNOOC
 Date of sampling : 23rd Dec 2013
 Serial no : LIMNO/2014/03

Sampled by: Eco & Partner and Golder Associates
 Date received: 23rd Dec 2013
 Date of reporting: 3 March 2014

Source Name	Kyabasambu stream	Kyenyanya BH	Busigi BH	Busigi stream	Ususa spring	Kina BH	Kina shores	US 201 DRINKING POTABLE WATER SPECIFICATION CLASS II
Source Location/GPS	Eastings Northings	253969 144783	252471 143039	252682 142819	257901 147698	246306 133757	246408 133715	
Parameters	Units/Lab No.	E22160	E22158	E22159	E22155	E22152	E22151	
Conductivity	µs/cm	671	1766	543	667	4400	634	2500
pH	--	10.1	10.2	10.1	9.3	7.75	10.1	6.5-8.5
Alkalinity	mg/L	88	100	80	76	48	84	500
Total Dissolved Solids	mg/L	906	307	335	197.5	20100	326	1200
Total Suspended Solids	mg/L	0	0	3	4	24	0	0
Turbidity	NTU	1	1	1	2	1	0	10
Calcium: Ca ²⁺	mg/L	56	56	48	72	2000	32	75
Magnesium: Mg ²⁺	mg/L	33.6	33.6	110.4	28.8	186	43.2	50
Iron: Total	mg/L	0	0	0.01	0.01	0.06	0.01	1
Fluoride: F ⁻	mg/L	1	1.2	1.2	1	1.1	0.9	1.5
Chloride: Cl ⁻	mg/L	0.03	0.03	0.03	0.03	3.3	0.03	500
Nitrate	mg/L	1.3	1.33	1.49	0.03	1.64	4.4	5
Ammonia	mg/L	0.5	0	0	0.2	0	0	1
Total Phosphorus	mg/L	0.07	0.17	0.26	0.15	0.04	0.05	10
Total Nitrogen	mg/L	0.13	2.45	0.057	0.29	1.18	0.37	10

NOTE:

- SDR Standard Deviation; AQC = Analytical Quality Control; NR = not Required; ND = Not Done
- S. D. values have been quoted only form methods that have been validated in our laboratory.
- The type of sample container and sample holding time affect the integrity of the sample and hence the results of analysis

PRINCIPAL ANALYST LABORATORIES

★ 26 MAR 2014 ★

NATIONAL WATER QUALITY REFERENCE LABORATORY - ENTEBBE

Sign:.....

Checked: *[Signature]*
 Laboratory Manager
 Date: 26/03/2014

Issued: *[Signature]*
 Principal Analyst
 Date:

MANAGER

Directorate of Water Resources Management Department
 P.O Box 19, Entebbe
 Tel: 041-321342
 Fax: 041-321368



Republic of Uganda

NATIONAL WATER QUALITY REFERENCE LABORATORY - ENTEBBE

Certificate of Analysis

Sampled by: Eco & Partner and Golder Associates
 Date received: 23rd Dec 2013
 Date of reporting: 3 March 2014

Name of client : CNOOC
 Date of sampling : 23rd Dec 2013
 Serial no : LIMNO/2014/03

Source Name	CNOOC SW1		CNOOC SW2		CNOOC SW4		CNOOC SW6		CNOOC SW9		US 201 DRINKING POTABLE WATER SPECIFICATION CLASS II
	Northerings		Northerings		Northerings		Northerings		Northerings		
Source location/GPS	Eastings		Eastings		Eastings		Eastings		Eastings		
Parameters	Units/Lab No.		Units/Lab No.		Units/Lab No.		Units/Lab No.		Units/Lab No.		
Conductivity	984		711		488		445		227		2500
pH	8.63		9.29		9.11		9.25		9.03		6.5-8.5
Alkalinity	76		88		100		80		76		500
Total Dissolved Solids	284		906		307		335		197.5		1200
Total Suspended Solids	1		0		0		3		4		0
Turbidity	1		1		1		1		2		10
Calcium: Ca ²⁺	48		56		56		48		72		75
Magnesium: Mg ²⁺	19.2		33.6		33.6		110.4		28.8		50
Iron: Total	0.05		0		0		0.01		0.01		1
Fluoride: F ⁻	1.2		1		1.2		1.2		1		1.5
Chloride: Cl ⁻	0.03		0.03		0.03		0.03		0.03		500
Nitrate	0.13		0.11		0.04		0.17		0.15		5
Ammonia	0		0		0		0		0		1
Total Phosphorus	0.23		0.14		0.08		0.12		0.05		10
Total Nitrogen	0.21		0.21		0.28		0.07		0.16		10

PRINCIPAL ANALYST LABORATORIES

Principal Analyst: **6 MAR 2014** ★

Date: NATIONAL WATER QUALITY REFERENCE LABORATORY - ENTEBBE

Sign:

NOTE:

- S.D. = Standard Deviation; AQC = Analytical Quality Control; NR = not Required; ND = Not Done
- P.S. D. values have been quoted only from methods that have been validated in our laboratory.
- The type of sample container and sample holding time affect the integrity of the sample and hence the results of analysis

Checked: *[Signature]*
 Laboratory Manager
 Date: 26/03/2014

Directorate of Water Resources Management Department
 P.O Box 19, Entebbe
 Tel: 041-321342
 Fax: 041-321368



Republic of Uganda

NATIONAL WATER QUALITY REFERENCE LABORATORY - ENTEBBE

Certificate of Analysis

Sampled by: Eco & Partner and Golder Associates
 Date received: 23rd Dec 2013
 Date of reporting: 3 March 2014

Name of client : CNOOC
 Date of sampling : 23rd Dec 2013
 Serial no : LIMNO/2014/03

Source Name	CNOOC SW12	CNOOC SW14	CNOOC GW1	CNOOC GW2	US 201 DRINKING POTABLE WATER SPECIFICATION CLASS II
Source location/GPS	Northings N01°14'51.3" Eastings E30°44'21.0"	N01°13'13.9" E30°43'23.1"	N01°14'31.6" E30°44'17.4"	N01°13'56.1" E30°43'38.8"	
Parameters	Units/Lab No.	E22167	E22168	E22169	
Conductivity	µs/cm	250	10540	7060	2500
pH	--	8.53	7.43	7.82	6.5-8.5
Alkalinity	mg/L	84	80	36	500
Total Dissolved Solids	mg/L	326	249	470	1200
Total Suspended Solids	mg/L	0	2	5	0
Turbidity	NTU	0	1	2	10
Calcium: Ca ²⁺	mg/L	32	40	112	75
Magnesium: Mg ²⁺	mg/L	43.2	19.2	24	50
Iron: Total	mg/L	0.01	0.02	0.04	1
Fluoride: F ⁻	mg/L	0.9	1	0.7	1.5
Chloride: Cl ⁻	mg/L	0.03	0.03	0.03	500
Nitrate	mg/L	0.13	0.11	0.13	5
Ammonia	mg/L	0	0	0	1
Total Phosphorus	mg/L	0.06	0.056	0.092	10
Total Nitrogen	mg/L	0.17	0.273	0.247	10

NOTE:

1. S.D. = Standard Deviation; AQC = Analytical Quality Control; NR = not Required; ND = Not Done
2. S.D. values have been quoted only form methods that have been validated in our laboratory.
3. The type of sample container and sample holding time affect the integrity of the sample and hence the results of analysis

Checked:
 Laboratory Manager
 Date: **CHECKE**
DATE 26/03/2014

PRINCIPAL ANALYST LABORATORIES

★ **26 MAR 2014** ★

NATIONAL WATER QUALITY REFERENCE LABORATORY - ENTEBBE

Sign:.....

Issued
 Principal Analyst
 Date:

Directorate of Water Resources Management Department
 P.O Box 19, Entebbe
 Tel: 041-321342
 Fax: 041-321368



Republic of Uganda

NATIONAL WATER QUALITY REFERENCE LABORATORY - ENTEBBE

Certificate of Analysis

Name of client : CNOOC
 Date of sampling : 23rd Dec 2013
 Serial no : LIMNO/2014/03

Sampled by: Eco & Partner and Golder Associates
 Date received: 23rd Dec 2013
 Date of reporting: 3 March 2014

Source Name	Kachunde stream	Ususa BH (shallow well)	L. Albert	Senjojo stream	Nsonga shorelines	US 201 DRINKING POTABLE WATER SPECIFICATION CLASS II
Source Location/GPS	Eastings Northings	257853 148016	244514 130739	243427 127536	248343 138448	
Parameters	Units/Lab No.	E22156	E22149	E22153	E22150	
Conductivity	µs/cm	440	576	293	589	2500
pH	--	9.95	9.96	9.68	10.03	6.5-8.5
Alkalinity	mg/L	80	48	36	88	500
Total Dissolved Solids	mg/L	249	390.4	373.8	387.8	1200
Total Suspended Solids	mg/L	2	0	3	9	0
Turbidity	NTU	1	1	2	6	10
Calcium: Ca ²⁺	mg/L	40	27.2	136	16	75
Magnesium: Mg ²⁺	mg/L	19.2	34.6		48	50
Iron: Total	mg/L	0.02	0.02	0.01	0.04	1
Fluoride: F ⁻	mg/L	1	0.9	1	0.9	1.5
Chloride: Cl ⁻	mg/L	0.03	0.03	0.03	0.03	500
Nitrate	mg/L	0.03	0.04	0.03	0.11	5
Ammonia	mg/L	0	0	0	0	1
Total Phosphorus	mg/L	0.1	0.05	0.05	0.15	10
Total Nitrogen	mg/L	0.28	0.27	0.31	0.12	10

NOTE:

- S.D. = Standard Deviation; AQC = Analytical Quality Control; NR = not Required; ND = Not Done
- S.D. values have been quoted only form methods that have been validated in our laboratory.
- The type of sample container and sample holding time affect the integrity of the sample and hence the results of analysis

Checked:

Laboratory Manager *[Signature]*
 Date: **CHECKED**
DATE 26/03/2014

Issued

Principal Analyst *[Signature]*
 Date: **26 MAR 2014**



Directorate of Water Resources Management Department
 P.O Box 19, Entebbe
 Tel: 041-321342
 Fax: 041-321368



Republic of Uganda

Form C

NATIONAL WATER QUALITY REFERENCE LABORATORY - ENTEBBE

CERTIFICATE OF ANALYSIS

Name of client : CNOOC
 Date of sampling : 23rd Dec 2013
 Serial no : LIMNO/2014/03

Sampled by: Eco & Partner and Golder Associates
 Date received: 23rd Dec 2013
 Date of reporting: 3 March 2014

Source name	CNOOC SW 12	CNOOC SW 14	CNOOC GW 1	CNOOC GW 2	Acceptable Standard NEMA, 1995
Source location/GPS	Eastings	N01°14'51.3"	N01°14'31.6"	N01°13'56.1"	
	Northings	E30°44'21.0"	E30°44'17.4"	E30°43'38.8"	
Parameters	Units/Lab No	E22166	E22168	E22169	
Cadmium (Cd)	mg/L	<0.0005	0.0561	<0.0005	0.01
Chromium (Cr)	mg/L	0.0006	0.0633	0.0008	0.05
Lead (Pb)	mg/L	0.0044	0.0693	0.0059	0.01
Mercury (Hg)	mg/L	0.001	0.0032	0.001	0.001
Iron (Fe)	mg/L	<0.002	1.5887	<0.002	0.03-3.5
Aluminium (Al)	mg/L	<0.006	0.527	<0.006	0.2
Arsenic (As)	mg/L	<0.003	<0.003	<0.003	0.01
Copper (Cu)	mg/L	<0.0004	0.0581	0.0024	1
Manganese (Mn)	mg/L	0.0013	0.0628	0.0046	0.1-0.5
Zinc (Zn)	mg/L	<0.001	0.0815	<0.001	3
Cobalt (Co)	mg/L	0.0018	0.0607	<0.001	NS
Nickel (Ni)	mg/L	<0.005	0.0615	<0.005	0.02
Selenium (Se)	mg/L	0.0274	0.0707	0.0416	0.01

NOTE:

- The type of sample container and sample holding time affect the integrity of the sample and hence the results of analysis
- Values lower than the detection limit reported as <DL
- DL stands for Detection Limit

Checked: 
 Laboratory Manager
 Date: 26/03/2014

PRINCIPAL ANALYST LABORATORIES

Issued 26 MAR 2014
 Principal Analyst

NATIONAL WATER QUALITY REFERENCE LABORATORY - ENTEBBE

Sign: 

Directorate of Water Resources Management Department
 P.O Box 19, Entebbe
 Tel: 041-321342
 Fax: 041-321368



NATIONAL WATER QUALITY REFERENCE LABORATORY - ENTEBBE

CERTIFICATE OF ANALYSIS

Name of client : CNOOC
 Date of sampling : 23rd Dec 2013
 Serial no : LIMNO/2014/03

Sampled by: Eco & Partner and Golder Associates
 Date received: 23rd Dec 2013
 Date of reporting: 3 March 2014

Source name	Eastings	Northings	Kachunde stream	Ususa BH (shallow well)	L. Albert	Senjojo stream	Nsonga shorelines	Acceptable Standard
Source location/GPS			245312E	257853E	244514E	243427E	248343E	NEMA, 1995
			130206N	148016N	130739N	127536N	138448N	
Parameters	Units/Lab No		E22156	E22154	E22149	E22153	E22150	
Cadmium (Cd)	mg/L		<0.0005	<0.0005	<0.0005	<0.0005	<0.0005	0.01
Chromium (Cr)	mg/L		0.0004	0.0007	0.0004	<0.0002	0.0003	0.05
Lead (Pb)	mg/L		<0.0004	<0.0004	0.0025	<0.0004	0.0025	0.01
Mercury (Hg)	mg/L		<0.001	<0.001	0.001	<0.001	0.0011	0.001
Iron (Fe)	mg/L		<0.002	<0.002	<0.002	<0.002	<0.002	0.03-3.5
Aluminium (Al)	mg/L		0.168	<0.006	0.193	<0.006	0.034	0.2
Arsenic (As)	mg/L		<0.003	<0.003	<0.003	<0.003	<0.003	0.01
Copper (Cu)	mg/L		<0.0004	<0.0004	<0.0004	<0.0004	<0.0004	1
Manganese (Mn)	mg/L		0.0007	0.1633	0.0008	<0.0004	0.0007	0.1-0.5
Zinc (Zn)	mg/L		<0.001	<0.001	<0.001	<0.001	<0.001	3
Cobalt (Co)	mg/L		0.001	<0.001	0.001	<0.001	0.001	NS
Nickel (Ni)	mg/L		<0.005	<0.005	<0.005	<0.005	<0.005	0.02
Selenium (Se)	mg/L		0.0134	0.0027	0.0244	0.011	0.0141	0.01

NOTE:

- The type of sample container and sample holding time affect the integrity of the sample and hence the results of analysis
- Values lower than the detection limit reported as <DL
- DL stands for Detection Limit

Checked:
 Laboratory Manager
 Date: 26/03/2014

Principal ANALYST LABORATORIES
 Issued Principal Analyst 26 MAR 2014
 Date: NATIONAL WATER QUALITY REFERENCE LABORATORY - ENTEBBE
 Sign:

Directorate of Water Resources Management Department
 P.O Box 19, Entebbe
 Tel: 041-321342
 Fax: 041-321368



NATIONAL WATER QUALITY REFERENCE LABORATORY - ENTEBBE

CERTIFICATE OF ANALYSIS

Name of client : CNOOC
 Date of sampling : 23rd Dec 2013
 Serial no : LIMNO/2014/03

Sampled by: Eco & Partner and Golder Associates
 Date received: 23rd Dec 2013
 Date of reporting: 3 March 2014

Source name	CNOOC SW1	CNOOC SW 2	CNOOC SW 4	CNOOC SW 6	CNOOC SW 9	Acceptable Standard
Source location/GPS	Eastings	Northings	Units/Lab No			
	N01°15'53.6"	N01°15'50.6"	N01°15'16.4"	N01°14'24.9"	N01°13'40.9"	
	E30°45'27.5"	E30°45'35.7"	E30°45'33.0"	E30°45'26.1"	E30°45'10.0"	NEMA, 1995
Parameters						
Cadmium (Cd)	E22161	E22162	E22163	E22164	E22165	
	<0.0005	<0.0005	<0.0005	<0.0005	<0.0005	0.01
Chromium (Cr)	0.0002	0.0005	0.0004	0.0006	0.0004	0.05
Lead (Pb)	0.0042	<0.0004	<0.0004	<0.0004	<0.0004	0.01
Mercury (Hg)	0.001	<0.001	<0.001	<0.001	<0.001	0.001
Iron (Fe)	<0.002	<0.002	<0.002	<0.002	<0.002	0.03-3.5
Aluminium (Al)	0.201	<0.006	<0.006	<0.006	<0.006	0.2
Arsenic (As)	<0.003	<0.003	<0.003	<0.003	<0.003	0.01
Copper (Cu)	<0.0004	<0.0004	<0.0004	<0.0004	<0.0004	1
Manganese (Mn)	0.001	0.0015	<0.0004	0.0004	0.0011	0.1-0.5
Zinc (Zn)	<0.001	<0.001	<0.001	<0.001	<0.001	3
Cobalt (Co)	<0.001	<0.001	<0.001	0.001	<0.001	NS
Nickel (Ni)	<0.005	<0.005	<0.005	<0.005	<0.005	0.02
Selenium (Se)	0.0309	0.0217	0.0255	0.0181	0.008	0.01

NOTE:

- The type of sample container and sample holding time affect the integrity of the sample and hence the results of analysis
- Values lower than the detection limit reported as <DL
- DL stands for Detection Limit

Checked:
 Laboratory Manager
 Date: 26/02/2014

Directorate of Water Resources Management Department
 P.O Box 19, Entebbe
 Tel: 041-321342
 Fax: 041-321368

Principal Analyst
 LABORATORIES
 Issued 26 MAR 2014
 Principal Analyst
 NATIONAL WATER QUALITY
 REFERENCE LABORATORY - ENTEBBE
 Sign:



Republic of Uganda

NATIONAL WATER QUALITY REFERENCE LABORATORY - ENTEBBE

CERTIFICATE OF ANALYSIS

Name of client : CNOOC
 Date of sampling : 23rd Dec 2013
 Serial no : LIMNO/2014/03

Sampled by: Eco & Partner and Golder Associates
 Date received: 23rd Dec 2013
 Date of reporting: 3 March 2014

Source name	Kyabasambu stream		Kyenyanja BH	Busigi BH	Busigi stream	Ususa spring	Kina BH	Kina shores	Acceptable Standard NEMA, 1995
	Eastings	Northings							
Parameters	Units/Lab No								
Cadmium (Cd)	mg/L		<0.0005	<0.0005	<0.0005	<0.0005	<0.0005	<0.0005	0.01
Chromium (Cr)	mg/L		<0.0002	0.0003	0.0002	0.0006	<0.0002	0.0002	0.05
Lead (Pb)	mg/L		<0.0004	<0.0004	0.0006	<0.0004	<0.0004	0.0004	0.01
Mercury (Hg)	mg/L		0.001	0.001	0.0011	<0.001	<0.001	0.0012	0.001
Iron (Fe)	mg/L		<0.002	<0.002	<0.002	<0.002	0.0303	<0.002	0.03-3.5
Aluminium (Al)	mg/L		<0.006	<0.006	<0.006	<0.006	<0.006	<0.006	0.2
Arsenic (As)	mg/L		<0.003	<0.003	<0.003	<0.003	<0.003	<0.003	0.01
Copper (Cu)	mg/L		<0.0004	<0.0004	<0.0004	<0.0004	<0.0004	<0.0004	1
Manganese (Mn)	mg/L		0.0016	0.0068	0.0013	0.0005	0.1189	0.0004	0.1-0.5
Zinc (Zn)	mg/L		<0.001	<0.001	<0.001	<0.001	0.2079	<0.001	3
Cobalt (Co)	mg/L		<0.001	<0.001	<0.001	<0.001	0.0011	0.001	NS
Nickel (Ni)	mg/L		<0.005	<0.005	<0.005	<0.005	<0.005	<0.005	0.02
Selenium (Se)	mg/L		0.01	0.0133	0.0158	0.0131	<0.001	0.0121	0.01

NOTE:

1. The type of sample container and sample holding time affect the integrity of the sample and hence the results of analysis
2. Values lower than the detection limit reported as <DL
3. DL stands for Detection Limit

Checked:

Laboratory Manager

Date:

CHECKED

DATE 26/03/2014

MANAGER

Directorate of Water Resources Management Department
 P.O Box 19, Entebbe
 Tel: 041-321342
 Fax: 041-321368

**PRINCIPAL ANALYST
LABORATORIES**

Issued: 26 MAR 2014
 Principal Analyst
 Date: NATIONAL WATER QUALITY
 REFERENCE LABORATORY - ENTEBBE
 Sign:



Jones Environmental Laboratory

Registered Address : Unit 3 Deeside Point, Zone 3, Deeside Industrial Park, Deeside, CH5 2UA. UK

Unit 3 Deeside Point
Zone 3
Deeside Industrial Park
Deeside
CH5 2UA

Golder Associates Africa Ltd
12 Steven Street
Universitas
Bloemfontein
Free State
9301
South Africa

Tel: +44 (0) 1244 833780

Fax: +44 (0) 1244 833781



Attention : Jennifer Pretorius
Date : 13th March, 2014
Your reference : CNOOC 12614848
Our reference : Test Report 14/3564 Batch 1
Location : Kingfisher
Date samples received : 6th March, 2014
Status : Final report
Issue : 1

Five samples were received for analysis on 6th March, 2014. Please find attached our Test Report which should be read with notes at the end of the report and should include all sections if reproduced. Interpretations and opinions are outside the scope of any accreditation, and all results relate only to samples supplied.

All analysis is carried out on as received samples and reported on a dry weight basis unless stated otherwise. Results are not surrogate corrected.

Compiled By:

Paul Lee-Boden BSc
Project Manager

Bob Millward BSc FRSC
Principal Chemist

NOTES TO ACCOMPANY ALL SCHEDULES AND REPORTS

JE Job No.: 14/3564

SOILS

Please note we are only MCERTS accredited for sand, loam and clay and any other matrix is outside our scope of accreditation.

Where an MCERTS report has been requested, you will be notified within 48 hours of any samples that have been identified as being outside our MCERTS scope. As validation has been performed on clay, sand and loam, only samples that are predominantly these matrices, or combinations of them will be within our MCERTS scope. If samples are not one of a combination of the above matrices they will not be marked as MCERTS accredited.

It is assumed that you have taken representative samples on site and require analysis on a representative subsample. Stones will generally be included unless we are requested to remove them.

All samples will be discarded one month after the date of reporting, unless we are instructed to the contrary. If we are instructed to keep samples, a storage charge of £1 (1.5 Euros) per sample per month will be applied until we are asked to dispose of them.

If you have not already done so, please send us a purchase order if this is required by your company.

Where appropriate please make sure that our detection limits are suitable for your needs, if they are not, please notify us immediately.

All analysis is reported on a dry weight basis unless stated otherwise. Results are not surrogate corrected. Samples are dried at 35°C ±5°C unless otherwise stated. Moisture content for CEN Leachate tests are dried at 105°C ±5°C.

Where Mineral Oil or Fats, Oils and Grease is quoted, this refers to Total Aliphatics C10-C40.

Where a CEN 10:1 ZERO Headspace VOC test has been carried out, a 10:1 ratio of water to wet (as received) soil has been used.

WATERS

Please note we are not a Drinking Water Inspectorate (DWI) Approved Laboratory. It is important that detection limits are carefully considered when requesting water analysis.

UKAS accreditation applies to surface water and groundwater and one other matrix which is analysis specific, any other liquids are outside our scope of accreditation

As surface waters require different sample preparation to groundwaters the laboratory must be informed of the water type when submitting samples.

Where Mineral Oil or Fats, Oils and Grease is quoted, this refers to Total Aliphatics C10-C40.

DEVIATING SAMPLES

Samples must be received in a condition appropriate to the requested analyses. All samples should be submitted to the laboratory in suitable containers with sufficient ice packs to sustain an appropriate temperature for the requested analysis. If this is not the case you will be informed and any test results that may be compromised highlighted on your deviating samples report.

SURROGATES

Surrogate compounds are added during the preparation process to monitor recovery of analytes. However low recovery in soils is often due to peat, clay or other organic rich matrices. For waters this can be due to oxidants, surfactants, organic rich sediments or remediation fluids. Acceptable limits for most organic methods are 70 - 130% and for VOCs are 50 - 150%. When surrogate recoveries are outside the performance criteria but the associated AQC passes this is assumed to be due to matrix effect. Results are not surrogate corrected.

NOTE

Data is only accredited when all the requirements of our Quality System have been met. In certain circumstances where the requirements have not been met, the laboratory may issue the data in an interim report but will remove the accreditation, in this instance results should be considered indicative only. Where possible samples will be re-extracted and a final report issued with accredited results. Please do not hesitate to contact the laboratory if further details are required of the circumstances which have led to the removal of accreditation.

ABBREVIATIONS and ACRONYMS USED

#	UKAS accredited.
B	Indicates analyte found in associated method blank.
DR	Dilution required.
M	MCERTS accredited.
NA	Not applicable
NAD	No Asbestos Detected.
ND	None Detected (usually refers to VOC and/SVOC TICs).
NDP	No Determination Possible
SS	Calibrated against a single substance.
SV	Surrogate recovery outside performance criteria. This may be due to a matrix effect.
W	Results expressed on as received basis.
+	AQC failure, accreditation has been removed from this result, if appropriate, see 'Note' on previous page.
++	Result outside calibration range, results should be considered as indicative only and are not accredited.
*	Analysis subcontracted to a Jones Environmental approved laboratory.
CO	Suspected carry over
OC	Outside Calibration Range
NFD	No Fibres Detected

JE Job No: 14/3564

Test Method No.	Description	Prep Method No. (if appropriate)	Description	UKAS	MCERTS (soils only)	Analysis done on As Received (AR) or Air Dried (AD)	Reported on dry weight basis
TM4	16 PAH by GC-MS, modified USEPA 8270	PM30	In-house method based on USEPA 3510. Liquid samples are mixed with solvent and agitated with an automatic magnetic stirrer with a stir bar for 15 minutes to extract organic molecules. ISO 17025 accredited extraction method. All accreditation is matrix specific				
TM4	16 PAH by GC-MS, modified USEPA 8270	PM30	In-house method based on USEPA 3510. Liquid samples are mixed with solvent and agitated with an automatic magnetic stirrer with a stir bar for 15 minutes to extract organic molecules. ISO 17025 accredited extraction method. All accreditation is matrix specific	Yes			
TM5	In-House method based on USEPA 8015B. Determination of Extractable Petroleum Hydrocarbons (EPH) in the carbon chain length range of C8-40 by GC-FID. Accredited to ISO 17025 on soil and water samples and MCERTS (carbon banding only) on soils. All accreditation is matrix specific.	PM30	In-house method based on USEPA 3510. Liquid samples are mixed with solvent and agitated with an automatic magnetic stirrer with a stir bar for 15 minutes to extract organic molecules. ISO 17025 accredited extraction method. All accreditation is matrix specific	Yes			
TM20	TDS, TSS and TS - gravimetric	PM0	No preparation is required.				
TM27	In-House method based on USEPA 9056. Analysis of samples using a Dionex Ion-Chromatograph instrument.	PM0	No preparation is required.				
TM30	Trace Metal elements by ICP-OES (Inductively Coupled Plasma - Optical Emission Spectrometry) using Thermo iCAP 6000 series instrument. Accredited to ISO 17025 for soils and waters and MCERTS accredited for Soils. All accreditation is matrix specific.	PM14	In-house method based on USEPA 3005A. Acid digestion of water samples and analysis by ICP-OES as per method TM030W.ISO 17025 accredited extraction method. All accreditation is matrix specific				
TM30	Trace Metal elements by ICP-OES (Inductively Coupled Plasma - Optical Emission Spectrometry) using Thermo iCAP 6000 series instrument. Accredited to ISO 17025 for soils and waters and MCERTS accredited for Soils. All accreditation is matrix specific.	PM14	In-house method based on USEPA 3005A. Acid digestion of water samples and analysis by ICP-OES as per method TM030W.ISO 17025 accredited extraction method. All accreditation is matrix specific	Yes			
TM36	In-House method based on USEPA 8015B. Determination of Gasoline Range Organics (GRO) in the carbon chain range of C5-12 by headspace GC-FID. Accredited to ISO 17025 on soil and water samples and MCERTS accredited (carbon banding only) on soils. All accreditation is matrix specific.	PM12	In-house method based on USEPA 5021. Preparation of solid and liquid samples for headspace analysis. Samples are spiked with surrogates to facilitate quantification. ISO 17025 accredited extraction method. All accreditation is matrix specific	Yes			
TM38	Ionic analysis using the Thermo Aquakem Photometric Automatic Analyser. Accredited to ISO17025 and MCERTS for most analytes. All accreditation is matrix specific.	PM0	No preparation is required.	Yes			
TM52	Silica by Spectrophotometer	PM0	No preparation is required.				



Jones Environmental Laboratory

Registered Address : Unit 3 Deeside Point, Zone 3, Deeside Industrial Park, Deeside, CH5 2UA. UK

Unit 3 Deeside Point
Zone 3
Deeside Industrial Park
Deeside
CH5 2UA

Golder Associates Africa Ltd
12 Steven Street
Universitas
Bloemfontein
Free State
9301
South Africa

Tel: +44 (0) 1244 833780

Fax: +44 (0) 1244 833781



Attention : Jennifer Pretorius
Date : 14th March, 2014
Your reference : CNOOC 12614848
Our reference : Test Report 14/3628 Batch 1
Location :
Date samples received : 7th March, 2014
Status : Final report
Issue : 1

Fourteen samples were received for analysis on 7th March, 2014. Please find attached our Test Report which should be read with notes at the end of the report and should include all sections if reproduced. Interpretations and opinions are outside the scope of any accreditation, and all results relate only to samples supplied.

All analysis is carried out on as received samples and reported on a dry weight basis unless stated otherwise. Results are not surrogate corrected.

Compiled By:

Paul Lee-Boden BSc
Project Manager

Bob Millward BSc FRSC
Principal Chemist

Client Name: Golder Associates Africa Ltd
Reference: CNOOC 12614848
Location:
Contact: Jennifer Pretorius
JE Job No.: 14/3628

Report : Liquid

Liquids/products: V=40ml vial, G=glass bottle, P=plastic bottle
H=H₂SO₄, Z=ZnAc, N=NaOH, HN=HNO₃

J E Sample No.	1-7	8-14	15-21	22-28	29-35	36-42	43-49	50-56	57-63	64-70	Please see attached notes for all abbreviations and acronyms		
Sample ID	KABALE 1	KABALE 2	KABALE 3	KISOBA 1	KISOBA 2	KISOBA 3	HOHWA 1	KABEGARAIRE 1	KYARUSHESHA 1	KASOGA 1			
Depth													
COC No / misc													
Containers	V H H N P G	V H H N P G	V H H N P G	V H H N P G	V H H N P G	V H H N P G	V H H N P G	V H H N P G	V H H N P G	V H H N P G			
Sample Date	02/03/2014	02/03/2014	02/03/2014	02/03/2014	02/03/2014	02/03/2014	02/03/2014	03/03/2014	03/03/2014	03/03/2014			
Sample Type	Ground Water	Ground Water	Ground Water	Ground Water	Ground Water	Ground Water	Ground Water	Ground Water	Ground Water	Ground Water			
Batch Number	1	1	1	1	1	1	1	1	1	1			
Date of Receipt	07/03/2014	07/03/2014	07/03/2014	07/03/2014	07/03/2014	07/03/2014	07/03/2014	07/03/2014	07/03/2014	07/03/2014	LOD	Units	Method No.
Dissolved Aluminium #	<20	1098	<20	<20	<20	<20	<20	<20	267	<20	<20	ug/l	TM30/PM14
Dissolved Arsenic #	<2.5	<2.5	<2.5	<2.5	<2.5	<2.5	<2.5	<2.5	<2.5	<2.5	<2.5	ug/l	TM30/PM14
Dissolved Barium #	93	79	175	138	168	156	137	35	56	201	<3	ug/l	TM30/PM14
Dissolved Beryllium	<0.5	<0.5	<0.5	<0.5	<0.5	<0.5	<0.5	<0.5	<0.5	<0.5	<0.5	ug/l	TM30/PM14
Dissolved Cadmium #	<0.5	<0.5	<0.5	<0.5	<0.5	<0.5	<0.5	<0.5	<0.5	<0.5	<0.5	ug/l	TM30/PM14
Dissolved Calcium #	34.1	12.4	33.8	21.7	39.7	21.7	35.2	30.0	18.2	61.4	<0.2	mg/l	TM30/PM14
Total Dissolved Chromium #	<1.5	<1.5	<1.5	<1.5	<1.5	<1.5	<1.5	<1.5	<1.5	<1.5	<1.5	ug/l	TM30/PM14
Dissolved Copper #	<7	11	<7	14	40	<7	<7	<7	<7	<7	<7	ug/l	TM30/PM14
Total Dissolved Iron #	655	940	217	846	145	32	<20	2058	317	984	<20	ug/l	TM30/PM14
Dissolved Lead #	15	20	12	15	14	13	13	18	12	14	<5	ug/l	TM30/PM14
Dissolved Magnesium #	18.7	5.8	20.0	11.4	20.0	10.2	37.2	24.6	9.4	17.5	<0.1	mg/l	TM30/PM14
Dissolved Manganese #	10	56	130	30	125	33	50	103	82	351	<2	ug/l	TM30/PM14
Dissolved Mercury #	<1	<1	<1	<1	<1	<1	<1	<1	<1	<1	<1	ug/l	TM30/PM14
Dissolved Nickel #	2	2	<2	<2	<2	<2	<2	<2	<2	<2	<2	ug/l	TM30/PM14
Dissolved Potassium #	2.7	1.5	1.0	2.1	2.5	2.7	1.2	2.8	2.1	2.8	<0.1	mg/l	TM30/PM14
Dissolved Selenium #	<3	<3	<3	<3	<3	<3	<3	<3	<3	<3	<3	ug/l	TM30/PM14
Dissolved Sodium #	29.7	27.4	30.2	17.6	19.9	12.0	52.5	12.3	22.2	16.5	<0.1	mg/l	TM30/PM14
Dissolved Vanadium #	7.3	2.5	<1.5	3.2	<1.5	<1.5	11.1	<1.5	8.3	<1.5	<1.5	ug/l	TM30/PM14
Dissolved Zinc #	73	26	48	42	69	174	33	132	16	11	<3	ug/l	TM30/PM14
Total Hardness Dissolved (as CaCO3)	164	55	169	102	183	97	244	178	85	227	<1	mg/l	TM30/PM14
PAH MS													
Naphthalene #	<0.014	<0.014	<0.014	<0.014	<0.014	0.020	<0.014	<0.014	<0.014	<0.014	<0.014	ug/l	TM4/PM30
Acenaphthylene #	<0.013	<0.013	<0.013	<0.013	<0.013	<0.013	<0.013	<0.013	<0.013	<0.013	<0.013	ug/l	TM4/PM30
Acenaphthene #	<0.013	<0.013	<0.013	<0.013	<0.013	<0.013	<0.013	<0.013	<0.013	<0.013	<0.013	ug/l	TM4/PM30
Fluorene #	<0.014	<0.014	<0.014	<0.014	<0.014	<0.014	<0.014	<0.014	<0.014	<0.014	<0.014	ug/l	TM4/PM30
Phenanthrene #	<0.011	<0.011	<0.011	<0.011	<0.011	<0.011	<0.011	<0.011	<0.011	<0.011	<0.011	ug/l	TM4/PM30
Anthracene #	<0.013	<0.013	<0.013	<0.013	<0.013	<0.013	<0.013	<0.013	<0.013	<0.013	<0.013	ug/l	TM4/PM30
Fluoranthene #	<0.012	<0.012	<0.012	<0.012	<0.012	<0.012	<0.012	<0.012	<0.012	<0.012	<0.012	ug/l	TM4/PM30
Pyrene #	<0.013	<0.013	<0.013	<0.013	<0.013	<0.013	<0.013	<0.013	<0.013	<0.013	<0.013	ug/l	TM4/PM30
Benzo(a)anthracene #	<0.015	<0.015	<0.015	<0.015	<0.015	<0.015	<0.015	<0.015	<0.015	<0.015	<0.015	ug/l	TM4/PM30
Chrysene #	<0.011	<0.011	<0.011	<0.011	<0.011	<0.011	<0.011	<0.011	<0.011	<0.011	<0.011	ug/l	TM4/PM30
Benzo(k)fluoranthene #	<0.018	<0.018	<0.018	<0.018	<0.018	<0.018	<0.018	<0.018	<0.018	<0.018	<0.018	ug/l	TM4/PM30
Benzo(a)pyrene #	<0.016	<0.016	<0.016	<0.016	<0.016	<0.016	<0.016	<0.016	<0.016	<0.016	<0.016	ug/l	TM4/PM30
Indeno(123cd)pyrene #	<0.011	<0.011	<0.011	<0.011	<0.011	<0.011	<0.011	<0.011	<0.011	<0.011	<0.011	ug/l	TM4/PM30
Dibenzo(ah)anthracene #	<0.01	<0.01	<0.01	<0.01	<0.01	<0.01	<0.01	<0.01	<0.01	<0.01	<0.01	ug/l	TM4/PM30
Benzo(ghi)perylene #	<0.011	<0.011	<0.011	<0.011	<0.011	<0.011	<0.011	<0.011	<0.011	<0.011	<0.011	ug/l	TM4/PM30
PAH 16 Total #	<0.195	<0.195	<0.195	<0.195	<0.195	<0.195	<0.195	<0.195	<0.195	<0.195	<0.195	ug/l	TM4/PM30
Benzo(b)fluoranthene	<0.01	<0.01	<0.01	<0.01	<0.01	<0.01	<0.01	<0.01	<0.01	<0.01	<0.01	ug/l	TM4/PM30
Benzo(k)fluoranthene	<0.01	<0.01	<0.01	<0.01	<0.01	<0.01	<0.01	<0.01	<0.01	<0.01	<0.01	ug/l	TM4/PM30
PAH Surrogate % Recovery	107	104	101	92	80	107	102	87	108	87	<0	%	TM4/PM30
EPH (C8-C40) #	<10	<10	<10	<10	<10	<10	<10	<10	<10	<10	<10	ug/l	TM5/PM30

Client Name: Golder Associates Africa Ltd
Reference: CNOOC 12614848
Location:
Contact: Jennifer Pretorius
JE Job No.: 14/3628

Report : Liquid

Liquids/products: V=40ml vial, G=glass bottle, P=plastic bottle
 H=H₂SO₄, Z=ZnAc, N=NaOH, HN=HNO₃

J E Sample No.	1-7	8-14	15-21	22-28	29-35	36-42	43-49	50-56	57-63	64-70	Please see attached notes for all abbreviations and acronyms		
Sample ID	KABALE 1	KABALE 2	KABALE 3	KISOBA 1	KISOBA 2	KISOBA 3	HOHWA 1	KABEGARAIRE 1	KYARUSHESHA 1	KASOGA 1			
Depth													
COC No / misc													
Containers	V H H N P G	V H H N P G	V H H N P G	V H H N P G	V H H N P G	V H H N P G	V H H N P G	V H H N P G	V H H N P G	V H H N P G			
Sample Date	02/03/2014	02/03/2014	02/03/2014	02/03/2014	02/03/2014	02/03/2014	02/03/2014	03/03/2014	03/03/2014	03/03/2014			
Sample Type	Ground Water	Ground Water	Ground Water	Ground Water	Ground Water	Ground Water	Ground Water	Ground Water	Ground Water	Ground Water			
Batch Number	1	1	1	1	1	1	1	1	1	1			
Date of Receipt	07/03/2014	07/03/2014	07/03/2014	07/03/2014	07/03/2014	07/03/2014	07/03/2014	07/03/2014	07/03/2014	07/03/2014	LOD	Units	Method No.
GRO (>C4-C8) #	<10	<10	<10	<10	<10	<10	<10	<10	<10	<10	<10	ug/l	TM36/PM12
GRO (>C8-C12) #	<10	<10	<10	<10	<10	<10	<10	<10	<10	<10	<10	ug/l	TM36/PM12
GRO (>C4-C12) #	<10	<10	<10	<10	<10	<10	<10	<10	<10	<10	<10	ug/l	TM36/PM12
Fluoride	<0.3	<0.3	0.5	1.0	1.3	0.6	2.7	0.3	<0.3	1.7	<0.3	mg/l	TM27/PM0
Sulphate #	40.26	5.12	17.08	6.24	17.41	6.99	14.32	24.90	36.38	18.04	<0.05	mg/l	TM38/PM0
Chloride #	5.3	0.7	3.0	1.0	15.6	0.5	3.5	2.4	1.7	1.4	<0.3	mg/l	TM38/PM0
Ortho Phosphate as PO4 #	<0.06	<0.06	<0.06	<0.06	<0.06	<0.06	<0.06	<0.06	<0.06	<0.06	<0.06	mg/l	TM38/PM0
Nitrate as N #	0.23	0.49	0.26	0.97	0.17	0.46	1.93	0.15	1.33	0.17	<0.05	mg/l	TM38/PM0
Ammoniacal Nitrogen as N #	0.15	0.19	0.18	0.71	0.31	0.30	0.22	0.25	0.33	0.34	<0.03	mg/l	TM38/PM0
Total Alkalinity as CaCO3 #	198	114	218	146	206	118	336	186	100	252	<1	mg/l	TM75/PM0
Electrical Conductivity @25C #	444	233	433	298	448	247	643	391	277	475	<2	uS/cm	TM76/PM0
pH #	6.74	6.60	6.99	6.83	7.07	6.64	7.53	7.13	6.96	7.36	<0.01	pH units	TM73/PM0
Silica	53.10	61.80	25.90	37.60	36.70	32.20	33.90	33.40	36.00	46.90	<0.01	mg/l	TM52/PM0
Total Dissolved Solids	312	237	284	236	301	183	554	292	222	341	<10	mg/l	TM20/PM0

NOTES TO ACCOMPANY ALL SCHEDULES AND REPORTS

JE Job No.: 14/3628

SOILS

Please note we are only MCERTS accredited for sand, loam and clay and any other matrix is outside our scope of accreditation.

Where an MCERTS report has been requested, you will be notified within 48 hours of any samples that have been identified as being outside our MCERTS scope. As validation has been performed on clay, sand and loam, only samples that are predominantly these matrices, or combinations of them will be within our MCERTS scope. If samples are not one of a combination of the above matrices they will not be marked as MCERTS accredited.

It is assumed that you have taken representative samples on site and require analysis on a representative subsample. Stones will generally be included unless we are requested to remove them.

All samples will be discarded one month after the date of reporting, unless we are instructed to the contrary. If we are instructed to keep samples, a storage charge of £1 (1.5 Euros) per sample per month will be applied until we are asked to dispose of them.

If you have not already done so, please send us a purchase order if this is required by your company.

Where appropriate please make sure that our detection limits are suitable for your needs, if they are not, please notify us immediately.

All analysis is reported on a dry weight basis unless stated otherwise. Results are not surrogate corrected. Samples are dried at 35°C ±5°C unless otherwise stated. Moisture content for CEN Leachate tests are dried at 105°C ±5°C.

Where Mineral Oil or Fats, Oils and Grease is quoted, this refers to Total Aliphatics C10-C40.

Where a CEN 10:1 ZERO Headspace VOC test has been carried out, a 10:1 ratio of water to wet (as received) soil has been used.

WATERS

Please note we are not a Drinking Water Inspectorate (DWI) Approved Laboratory. It is important that detection limits are carefully considered when requesting water analysis.

UKAS accreditation applies to surface water and groundwater and one other matrix which is analysis specific, any other liquids are outside our scope of accreditation

As surface waters require different sample preparation to groundwaters the laboratory must be informed of the water type when submitting samples.

Where Mineral Oil or Fats, Oils and Grease is quoted, this refers to Total Aliphatics C10-C40.

DEVIATING SAMPLES

Samples must be received in a condition appropriate to the requested analyses. All samples should be submitted to the laboratory in suitable containers with sufficient ice packs to sustain an appropriate temperature for the requested analysis. If this is not the case you will be informed and any test results that may be compromised highlighted on your deviating samples report.

SURROGATES

Surrogate compounds are added during the preparation process to monitor recovery of analytes. However low recovery in soils is often due to peat, clay or other organic rich matrices. For waters this can be due to oxidants, surfactants, organic rich sediments or remediation fluids. Acceptable limits for most organic methods are 70 - 130% and for VOCs are 50 - 150%. When surrogate recoveries are outside the performance criteria but the associated AQC passes this is assumed to be due to matrix effect. Results are not surrogate corrected.

NOTE

Data is only accredited when all the requirements of our Quality System have been met. In certain circumstances where the requirements have not been met, the laboratory may issue the data in an interim report but will remove the accreditation, in this instance results should be considered indicative only. Where possible samples will be re-extracted and a final report issued with accredited results. Please do not hesitate to contact the laboratory if further details are required of the circumstances which have led to the removal of accreditation.

ABBREVIATIONS and ACRONYMS USED

#	UKAS accredited.
B	Indicates analyte found in associated method blank.
DR	Dilution required.
M	MCERTS accredited.
NA	Not applicable
NAD	No Asbestos Detected.
ND	None Detected (usually refers to VOC and/SVOC TICs).
NDP	No Determination Possible
SS	Calibrated against a single substance.
SV	Surrogate recovery outside performance criteria. This may be due to a matrix effect.
W	Results expressed on as received basis.
+	AQC failure, accreditation has been removed from this result, if appropriate, see 'Note' on previous page.
++	Result outside calibration range, results should be considered as indicative only and are not accredited.
*	Analysis subcontracted to a Jones Environmental approved laboratory.
CO	Suspected carry over
OC	Outside Calibration Range
NFD	No Fibres Detected

JE Job No: 14/3628

Test Method No.	Description	Prep Method No. (if appropriate)	Description	UKAS	MCERTS (soils only)	Analysis done on As Received (AR) or Air Dried (AD)	Reported on dry weight basis
TM4	16 PAH by GC-MS, modified USEPA 8270	PM30	In-house method based on USEPA 3510. Liquid samples are mixed with solvent and agitated with an automatic magnetic stirrer with a stir bar for 15 minutes to extract organic molecules. ISO 17025 accredited extraction method. All accreditation is matrix specific				
TM4	16 PAH by GC-MS, modified USEPA 8270	PM30	In-house method based on USEPA 3510. Liquid samples are mixed with solvent and agitated with an automatic magnetic stirrer with a stir bar for 15 minutes to extract organic molecules. ISO 17025 accredited extraction method. All accreditation is matrix specific	Yes			
TM5	In-House method based on USEPA 8015B. Determination of Extractable Petroleum Hydrocarbons (EPH) in the carbon chain length range of C8-40 by GC-FID. Accredited to ISO 17025 on soil and water samples and MCERTS (carbon banding only) on soils. All accreditation is matrix specific.	PM30	In-house method based on USEPA 3510. Liquid samples are mixed with solvent and agitated with an automatic magnetic stirrer with a stir bar for 15 minutes to extract organic molecules. ISO 17025 accredited extraction method. All accreditation is matrix specific	Yes			
TM20	TDS, TSS and TS - gravimetric	PM0	No preparation is required.				
TM27	In-House method based on USEPA 9056. Analysis of samples using a Dionex Ion-Chromatograph instrument.	PM0	No preparation is required.				
TM30	Trace Metal elements by ICP-OES (Inductively Coupled Plasma - Optical Emission Spectrometry) using Thermo iCAP 6000 series instrument. Accredited to ISO 17025 for soils and waters and MCERTS accredited for Soils. All accreditation is matrix specific.	PM14	In-house method based on USEPA 3005A. Acid digestion of water samples and analysis by ICP-OES as per method TM030W.ISO 17025 accredited extraction method. All accreditation is matrix specific				
TM30	Trace Metal elements by ICP-OES (Inductively Coupled Plasma - Optical Emission Spectrometry) using Thermo iCAP 6000 series instrument. Accredited to ISO 17025 for soils and waters and MCERTS accredited for Soils. All accreditation is matrix specific.	PM14	In-house method based on USEPA 3005A. Acid digestion of water samples and analysis by ICP-OES as per method TM030W.ISO 17025 accredited extraction method. All accreditation is matrix specific	Yes			
TM36	In-House method based on USEPA 8015B. Determination of Gasoline Range Organics (GRO) in the carbon chain range of C5-12 by headspace GC-FID. Accredited to ISO 17025 on soil and water samples and MCERTS accredited (carbon banding only) on soils. All accreditation is matrix specific.	PM12	In-house method based on USEPA 5021. Preparation of solid and liquid samples for headspace analysis. Samples are spiked with surrogates to facilitate quantification. ISO 17025 accredited extraction method. All accreditation is matrix specific	Yes			
TM38	Ionic analysis using the Thermo Aquakem Photometric Automatic Analyser. Accredited to ISO17025 and MCERTS for most analytes. All accreditation is matrix specific.	PM0	No preparation is required.	Yes			
TM52	Silica by Spectrophotometer	PM0	No preparation is required.				







APPENDIX B

Microbial Results

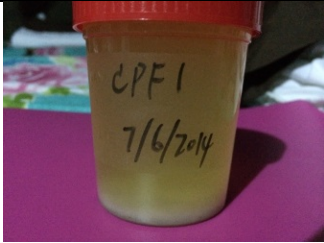
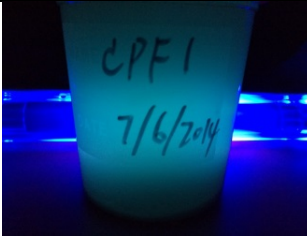
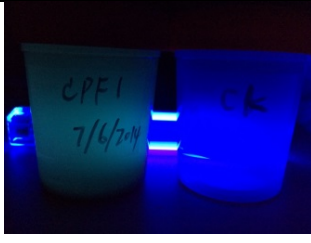
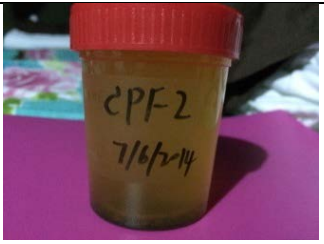
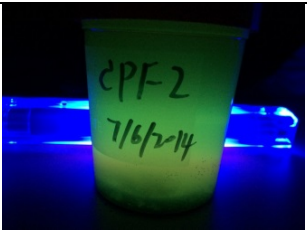

GROUNDWATER SPECIALIST STUDY

No.	I.D.	Coordinate	Pic of sampling location	Incubate duration /hrs (result)	Exposure to natural light	Exposure to UV light	Compared with CK under UV light
		East North					
Kingfisher (Buhuka Flat)							
1	KYABASA MBU-CPF 1	249035 138588		12 + <i>E. coli</i>			
2	NSONGA-CPF2 (KISONGA-CPF2)	247651 136606		12 + <i>E. coli</i>			
3	LAKE-JETTY	248405⁽¹⁾ 138059⁽¹⁾		12 + <i>E. coli</i>			









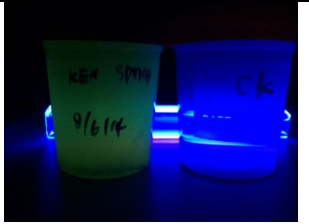

GROUNDWATER SPECIALIST STUDY

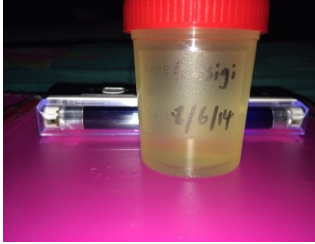
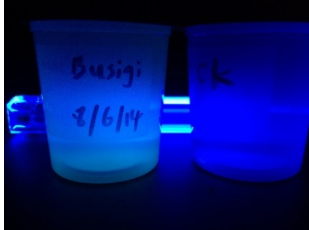
4	GRAVITY FLOW-CPF	249666 ⁽¹⁾ 136798 ⁽¹⁾		12 + <i>E. coli</i>			
5	USUSA (Light Yellow)	257849 147984		10 -coli			
6	USUSA SPRING	258083 ⁽¹⁾ 147372 ⁽¹⁾		10 + <i>E. coli</i>			
7	KENYANY A	253942 145068		10 + <i>E. coli</i>			

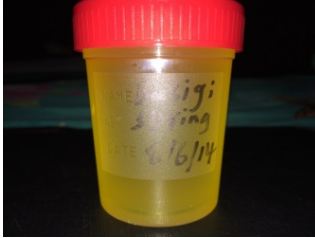

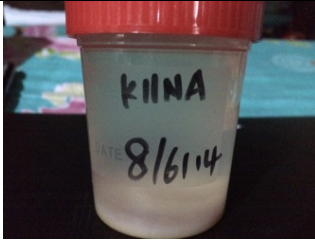





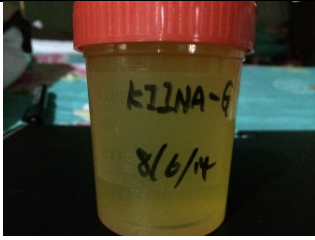

GROUNDWATER SPECIALIST STUDY

8	KYENYAN YA SPRING	254092⁽¹⁾ 144666⁽¹⁾		10 + <i>E. coli</i>			
9	BUSIGI (Light Yellow)	252524 142802		10 + <i>E. coli</i>			
10	BUSIGI SPRING	252752⁽¹⁾ 142487⁽¹⁾		10 + <i>E. coli</i>			
11	KIINA (White)	246304 133757		9 -coli			

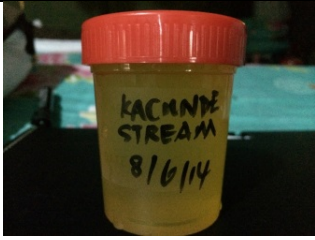
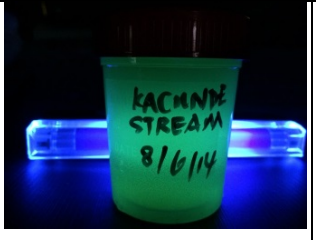
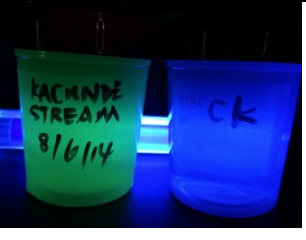
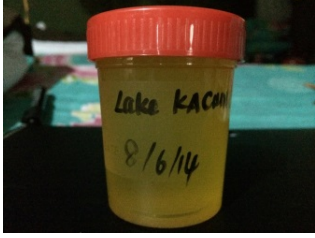

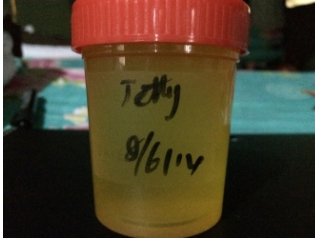
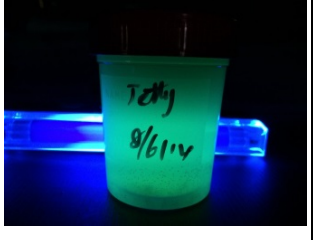
GROUNDWATER SPECIALIST STUDY

12	GRAVITY FLOW-KIINA	246585 ⁽¹⁾ 133720 ⁽¹⁾		9 + <i>E. coli</i>			
13	KACUMDE SPRING	245726 ⁽¹⁾ 129768 ⁽¹⁾		9 + <i>E. coli</i>			
14	LAKE-KACUMDE	245333 ⁽¹⁾ 130246 ⁽¹⁾		9 + <i>E. coli</i>			
15	LAKE-JETTY			9 + <i>E. coli</i>			











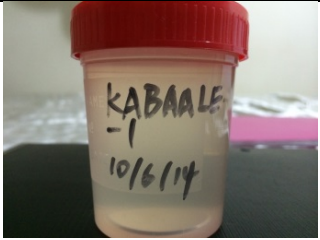

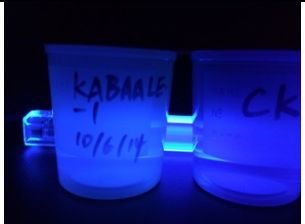
GROUNDWATER SPECIALIST STUDY

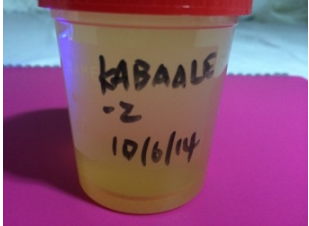
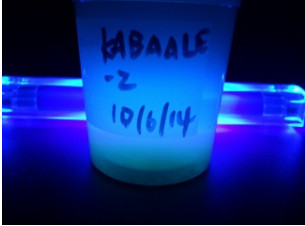
16	LAKE-JETTY DUP			9 + <i>E. coli</i>			
17	KYABASA MBU STREAM	250461 ⁽¹⁾ 137197 ⁽¹⁾		13 + <i>E. coli</i>			
Along the pipeline							
18	KABALE 1	283358 159091		8			

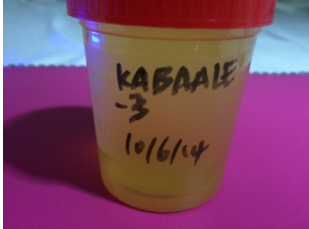
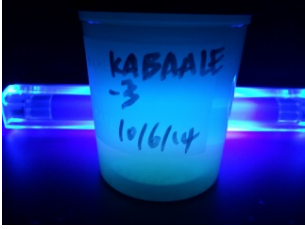

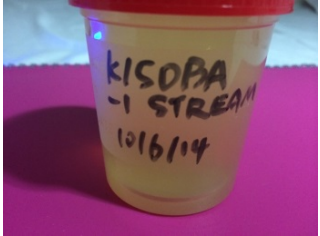
GROUNDWATER SPECIALIST STUDY

				29 -coli			
19	KABALE 2	282989 156593		8 + <i>E. coli</i>			
20	KABALE 3	282372 158165		8 + <i>E. coli</i>			
21	KISOBA 1- STREAM (NYANKER EBE)	276477⁽¹⁾ 150690⁽¹⁾		8 + <i>E. coli</i>			







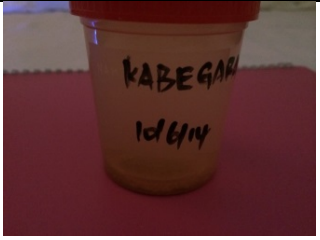
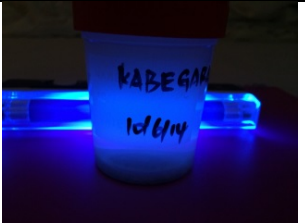
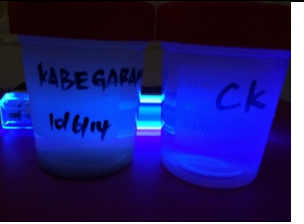
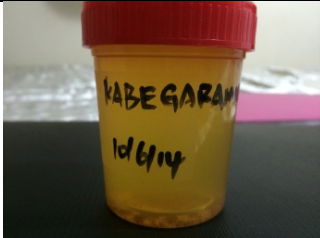

GROUNDWATER SPECIALIST STUDY

22	KISOBA 2	277189 ⁽¹⁾ 151949 ⁽¹⁾		8 + <i>E. coli</i>			
23	KISOBA 3	276408 150977		8			
				19 + <i>E. coli</i>			
24	HOHWA	274363 151941		9 + <i>E. coli</i>			

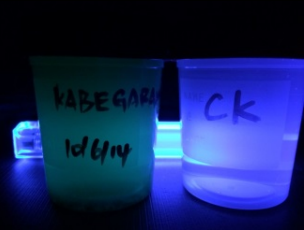

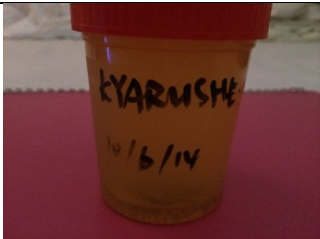
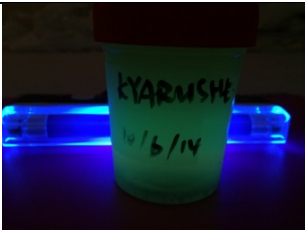



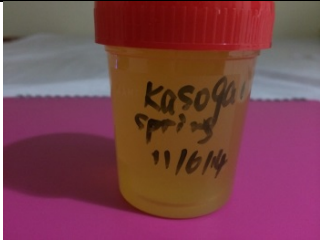
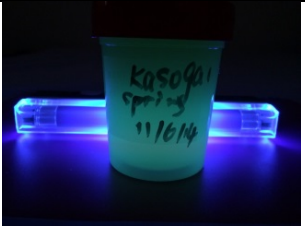
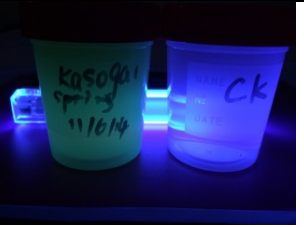

GROUNDWATER SPECIALIST STUDY

25	KABEGAR AMIRE 1	168722 146184		9 + <i>E. coli</i>			
				21 + <i>E. coli</i>			
26	KYARUSH ESHA	265845 145814		21 + <i>E. coli</i>			

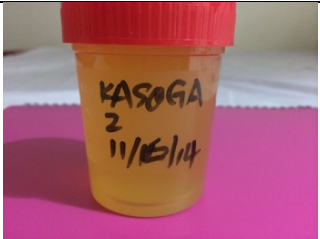
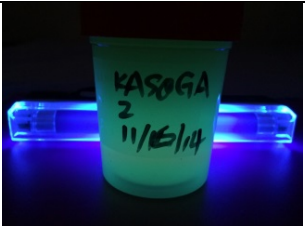

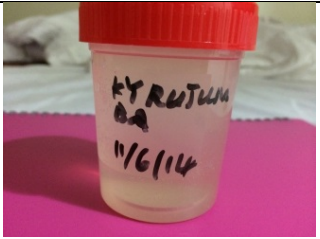
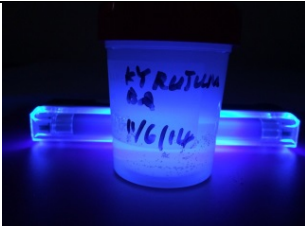
GROUNDWATER SPECIALIST STUDY

27	KASOGA 1-SPRING	261901 ⁽¹⁾ 144509 ⁽¹⁾		11 + <i>E. coli</i>			
28	KASOGA 2	261178 141699		11 + <i>E. coli</i>			
29	KYARUJU MBA	258094 141404		11 + <i>E. coli</i>			









GROUNDWATER SPECIALIST STUDY

				63 ⁽²⁾			
30	HANGA 2A	253800 139101		11			
				63 ⁽²⁾ -coli			
31	HANGA2B	253941 140082		11			

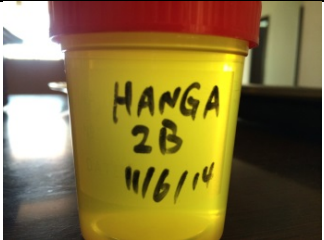

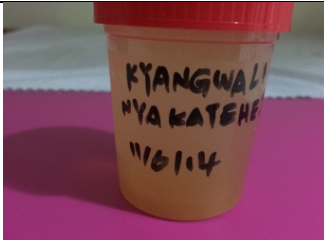

GROUNDWATER SPECIALIST STUDY

				63⁽²⁾ + <i>E. coli</i>			
32	KYANGWA LI NYAKATE HE I	256443⁽¹⁾ 135999⁽¹⁾		11 + <i>E. coli</i>			

Note :

(1)-- Coordinate for the new sampling location

(2)—incubated in natural temperature after 11hrs' incubation under 35°C



December 2017

REPORT – VOLUME 4, STUDY 4A



CNOOC UGANDA LIMITED

**KINGFISHER OIL PROJECT,
HOIMA DISTRICT, UGANDA -
SOIL IMPACT ASSESSMENT**

Submitted to:

The Executive Director National Environment Management Authority, NEMA House,
Plot 17/19/21 Jinja Road, P. O. Box 22255 Kampala, Uganda



Report Number: 1776816-323373-20

Distribution:

- 1 x electronic copy CNOOC Uganda Limited
- 1 x electronic copy NEMA
- 1 x electronic copy Eco & Partner
- 1 x electronic copy Golder





Executive Summary

This report represents the soil baseline and impact assessment for the Kingfisher Development Area in Hoima District Uganda by CNOOC Uganda Ltd. Understanding and managing soil chemical, physical and mechanical properties prior to establishment of oil and gas infrastructure for the project is essential to proactively identify and manage environmental liability risks to the surrounding environment.

The regional climate of the investigation area is tropical with a distinct wet and dry season with rainfall ranging between 700mm and 1,400mm per annum. Considering saturated and unsaturated flow conditions in soils under these rainfall conditions the soils will contain moisture ranging between 33 to 1,500kPa (field capacity to wilt point) with a discharge rate of approximately 5% of mean annual precipitation. Soil moisture affects the chemical, physical and mechanical properties of the soils in conjunction with the clay content and type of clay material and should be considered during the construction, operational and decommissioning phases of the project.

The objectives of the investigation were to obtain primary data from a baseline soil survey in order to (amongst others) assess the potential impact (negative and/or positive) on the soil environment, related to the proposed project activities. This assessment would also describe how any negative environmental impacts should be managed and how the positive impacts should be maximised.

From the assessment it was concluded that the dominant soil forms (as recorded and identified according to the FAO Soil classification System) at the Kingfisher Development Area are Ferrasols, Gleysols, Lithosols and Vertisols. On the Pipeline route Ferrasols and Lithosols were identified. The effective depth of the Ferrasols exceeds 300mm inclusive of the A and Oxic B - Horizons. The effective depth of the Lithosols, Vertisols and Gleysols is <300mm limited to Hard Rock, Vertic, and Histic H – Horizons.

The hypothesis is soils on the Kingfisher Development Area and Pipeline Route developed *in situ* through weathering of the underlying geology and hill wash from the adjacent escarpment on the eastern side. The soils of the Kingfisher Development Area weathered from dolerite geology and is characterised by high clay content (2:1 layer silicates) soils. Preferential seepage and natural drainage lines over time created wetland areas with characteristically gley mottling high clay content soils. The Pipeline route occurs on the escarpment, which is predominantly granite silica rich geology that weathered to light textured soils. There is a possibility that the deeper, sandy soils are wind transported deposits. The A - Horizon is rich in organic matter and micro-organism activity representing a delicate micro-habitat. The Oxic B – Horizon is characterised by well aerated and drained sandy soil profiles with an average clay content of 10-15% represented by predominantly 1:1 clay minerals. The Vertic and Histic H – Horizons are characterised by high clay content, low aerated, low permeability soil profiles with clay content >20% of mainly 2:1 clay minerals.

The high clay content soils will be characterised by an estimated plasticity index >20. The plasticity index will be a function of the clay percentage (>15%) and in conjunction with the swelling and shrinking capabilities of 2:1 layer silicates careful consideration should be given to civil design of project infrastructure and roads to ensure safety and stability.

The soils are characterised by neutral pH values (5.3 and 7.2) and low electrical conductivity values (<250mS/m). Under these conditions plant available nitrogen (15-20mg/kg), phosphorus (10-15mg/kg) and potassium (>50mg/kg) are readily available for plant uptake and sustainable plant growth. The A - Horizon is typically characterised by a low dense structure and texture distribution of approximately 65% sand, 20% silt and 15% clay with drainage properties in order of 10mm/h. The dominant clay mineral in the A and Oxic B – Horizon is kaolinite (1:1 layer silicate), with a low buffer capacity due to the low cation exchange capacity (<10cmol+/kg). The Vertic and Histic H – Horizons contain predominantly smectite (2:1 layer silicate) with high buffer capacity due to high cation exchange capacity (>10cmol+/kg). The soil horizons of the Ferrasols, Vertisols and Gleysols are suitable for rehabilitation purposes. The breakthrough curve of the clay soils to adsorb chemicals from accidental oil, diesel and chemical spills is higher than the sandy soils, however mitigation and remediation measures should be maintained by the same intensity for both type of soils.





SOIL IMPACT ASSESSMENT

The agricultural potential of the Ferrasols soils is considered medium to high under dryland (700 – 1,400mm/y rainfall) and irrigation conditions (>10-15mm/week 33-1,500kPa plant available water)

Evidence of severe soil erosion was observed during the investigation, especially along the shore line. Most of the evidence was linked to civil construction with a lack of surface water control measures in place. Interpretation of the analytical data indicate no excess sodium present in the soil solution exceeding 15% of the cation exchange capacity, which would have caused dispersion of clay particles that could lead to soil erosion. It is emphasised proper civil construction and surface water management control measures should be implemented and properly maintained during the construction, operational and decommissioning phases of the project.

The current land use on the Kingfisher Development Area includes 3,16% basecamp & airstrip infrastructure, 61,57% natural grassland, 0,7% cultivated land, 15,79% village and immediate surrounds and 18,82% wetland. The Pipeline route includes 17% natural grassland and 83% cultivated land. The current land capability of the Kingfisher Development Area includes 56% arable, 19% wetland and 252% wilderness. The pipeline route includes 83% arable and 17% grazing. Consideration should be given during site planning and layout of the project infrastructure to minimise impacts, especially with regards to disturbing villages and wetlands.

A soil stripping and stockpiling strategy has been compiled. During construction careful planning should be conducted with regards to stripping, handling and placement of topsoil. On the Kingfisher Development Area an estimated total 527ha could potentially be covered 300mm thick at a bulk density of 1,275kgm³ during rehabilitation taking into consideration a 10% loss of topsoil from the 1,758,000m³ due to handling, compaction etc. On the Pipeline route an estimated total 3,461ha could potentially be covered 300mm thick (bulk density 1,275kgm³) considering a 10% loss of topsoil from the 11,583,000m³.

A summary of the impact assessment for soils during construction, operation and decommissioning is summarised in Table 12 page 33:

Summary Impact Assessment Ratings: Soils.

Phase	Location	Before mitigation			After mitigation		
		Intensity	Sensitivity	Severity	Intensity	Sensitivity	Severity
Construction	Kingfisher Camps/Parking Lots/Material Yards	High	High	High	Low	High	Moderate
	Airstrip Extension	Medium	High	High	Low	High	Moderate
	Central Processing Facility (CPF)	High	High	High	Low	High	Moderate
	Pipeline	Medium	High	High	Low	High	Moderate
	New In-Roads	High	Medium	High	Low	High	Moderate
	Crusher Plant/Spoil Area A	Low	High	Moderate	Very Low	High	Minor
	New Well Pads	Medium	High	High	Low	High	Moderate
	Jetty	Low	High	Moderate	Very Low	High	Minor
Operation	Airstrip Extension	Medium	High	High	Low	High	Moderate
	New In-Roads	Medium	Low	Moderate	Low	Low	Minor
	New Well Pads	Medium	Low	Moderate	Low	Low	Minor
	Jetty	High	High	High	Low	High	Moderate
Decommission	All infrastructure	Medium	High	High	Low	High	Moderate





Table of Contents

1.0 INTRODUCTION	1
2.0 OBJECTIVES OF INVESTIGATION	1
3.0 SCOPE OF WORK.....	2
3.1 Project meeting	2
3.2 Desktop review of relevant information	2
3.3 Data collection	2
3.3.1 Sampling procedures	3
3.3.2 Inorganic soil analysis	3
4.0 ASSUMPTIONS AND LIMITATIONS	4
5.0 LEGISLATIVE AND POLICY CONTEXT	4
5.1 IFC Environmental, Health and Safety (EHS) guidelines.....	4
5.2 Ugandan soil legislation.....	5
5.2.1 Purpose	5
5.2.2 Schedules.....	5
5.2.3 Management of fragile soils.....	6
5.2.4 Parameters for determination of soil quality	6
5.2.4.1 Chemical parameters	6
5.2.4.2 Physical parameters	6
5.2.4.3 Soil conservation measures and guidelines.....	7
6.0 BASELINE SOIL ENVIRONMENT	7
6.1 Soil classification.....	7
6.2 Agricultural potential	10
6.3 Land use	11
6.4 Land capability.....	15
6.5 Erodibility of soils and evidence of misuse.....	18
6.5.1 Chemical mechanism.....	18
6.5.2 Situational analyses	19
6.6 Overview of soil chemical, physical and mineralogical properties.....	20
6.7 Assessment of suitability of soils for rehabilitation purposes.....	21
6.8 Soil conditions at different infrastructures	22





6.8.1	Soil types	22
6.8.2	Land use	24
6.8.3	Land capability	26
6.9	Soil conditions along infield roads	28
7.0	IMPACT ASSESSMENT	29
7.1	Impact assessment methodology	29
7.2	Description of potential impacts	29
7.2.1	Construction Phase Impacts	30
7.2.2	Operation Phase Impacts	31
7.2.3	Decommissioning Phase Impacts	32
7.2.4	Summary of impacts to soils	33
7.2.5	Cumulative impacts	33
7.2.6	Residual impacts	33
7.2.6.1	Soil Loss	33
7.2.6.2	Contamination	33
7.2.6.3	Erosion	34
7.2.6.4	Compaction	34
8.0	ENVIRONMENTAL MANAGEMENT PLAN / MITIGATION AND MONITORING MEASURES	34
8.1	Construction Phase	34
8.2	Operations Phase	36
8.3	Decommissioning Phase	38
8.4	Monitoring	39
8.4.1	Soil Monitoring	39
8.4.2	Ugandan Soil Quality Monitoring Regulations	40
8.4.2.1	Soil Physical Indicators	40
8.4.2.2	Soil Biology Indicators	40
8.4.2.3	Soil Chemical Indicators	40
8.5	Soil stripping utilisation guide and plan	40
8.5.1	Soil management	40
8.5.2	Basic volume calculations	41
8.5.3	Topsoil stripping general recommendations	42
8.5.3.1	Soil Layers	42
8.5.3.2	Field practice	42





8.5.3.3	Stripping with excavators and dump trucks	43
8.5.3.4	Stockpiles.....	46
8.5.3.5	Earth moving equipment.....	47
8.5.3.6	Contamination.....	48
9.0	CONCLUSIONS	50
10.0	REFERENCES	51

TABLES

Table 1: Analytical soil properties.....	3
Table 2: Agricultural potential of soils.....	11
Table 3: Land use at the Kingfisher Development Area and Pipeline route.....	13
Table 4: Criteria for determination of land capability.....	15
Table 5: Land capability of the Kingfisher Development Area and Pipeline route.....	15
Table 6: Summary of soil types at Kingfisher Development Area infrastructure.	24
Table 7: Summary of land use at Kingfisher Development Area infrastructure.....	26
Table 8: Land capability at Kingfisher Development Area infrastructure.....	28
Table 9: Soil types, land use and land capability of planned infield roads.	28
Table 10: Determination of impact severity.....	29
Table 11: Impact assessment criteria and rating scale.....	30
Table 12: Summary Impact Assessment Ratings: Soils.....	33
Table 13: Mitigation Measures Soils – Construction Phase.....	35
Table 14: Mitigation Measures Soils – Operations Phase.....	36
Table 15: Mitigation Measures Soils – Decommission Phase.....	38
Table 16: Analytical properties for soil monitoring.....	39
Table 17: Kingfisher Development Area available topsoil.....	50
Table 18: Pipeline route available topsoil.....	50

FIGURES

Figure 1: Examples of FAO classified soils (from left to right) - Ferralsol, Lithosol, Vertisol and Gleysol.	8
Figure 2: Soil types at the Kingfisher Development Area.....	9
Figure 3: Soil types along the Pipeline route.....	10
Figure 4: Land use at the Kingfisher Development Area.....	12
Figure 5: Land use along the Pipeline route.....	13
Figure 6: Current land use of Kingfisher Development Area.....	14
Figure 7: Estimated land use of the Pipeline route.....	14
Figure 8: Land capability of Kingfisher Development Area.....	16





Figure 9: Land capability of Pipeline route.	16
Figure 10: Land capability at Kingfisher Development Area.	17
Figure 11: Land capability along the Pipeline route.	18
Figure 12: Exchangeable sodium molecules on exchange sites of clay surfaces as percentage of cation exchange capacity.	19
Figure 13: Evidence of soil erosion at the Kingfisher Development Area.	20
Figure 14: Potential soil chemical, physical and mineralogical anomalies.	20
Figure 15: 1:1 (left) and 2:1 (right) clay mineral.	21
Figure 16: Conceptual Rehabilitation Framework.	21
Figure 17: Soil types at the Kingfisher Development Area infrastructure.	23
Figure 18: Land use at Kingfisher Development Area infrastructure.	25
Figure 19: Land capability at Kingfisher Development Area infrastructure.	27
Figure 20: Basic soil volume calculations.	41
Figure 21: Influence of colloidal fraction in topsoil stripping.	42
Figure 22: The bed strip system.	44
Figure 23: Removal of topsoil from a strip.	45
Figure 24: Stockpiling topsoil.	47
Figure 25: Dozer, excavator, tipper, grader and front end loader earth moving equipment.	48
Figure 26: Grader ripping compacted soil.	48
Figure 27: Influence of geology on soil contamination.	49

APPENDICES

APPENDIX A

Kingfisher Development Area soil observation points and GPS data

APPENDIX B

Pipeline Route Study Area soil observation points and GPS data

APPENDIX C

Summary of all soil observation points and samples

APPENDIX D

Chemical analysis results

APPENDIX E

Particle size analysis results

APPENDIX F

Exchangeable/extractable cation (CEC) analysis results

APPENDIX G

Heavy metal analysis results





ACRONYMS AND ABBREVIATIONS

CNOOC	China National Offshore Oil Corporation
CPF	Central Processing Facility
EBS	Environmental Baseline Study
EIA	Environmental Impact Assessment
EIS	Environmental Impact Statement
ESIA	Environmental and Social Impact Assessment
ESMP	Environmental and Social Management Plan
GIS	Geographic information system
Golder	Golder Associates Africa (Pty) Ltd
Ha	Hectares
IFC	International Finance Corporation
KF	Kingfisher
M	Meters
SOW	Scope of Work
TOR	Terms Of Reference

DEFINITIONS OF TERMINOLOGY

Auger	A tool for boring the soil and withdrawing small increments for field observation and sampling
Cation	A positively charged ion, for example Na ⁺ , Ca ²⁺ , Al ³⁺ . The term exchangeable base cations ordinarily refers to calcium, magnesium, potassium and sodium
Consistence	The degree of cohesion or adhesion within the soil mass or its resistance to deformation rupture
Electrical Conductivity (EC)	A measure of the ability of a material to conduct current and is a measure of the concentration of salts in solution
Ferralsols	Soils with an oxic B – Horizon. Hard laterite is common in these soils.
Gleysols	Very wet soils formed in unconsolidated materials excluding recent alluvium.
Horizon	A layer of soil or soil approximately parallel to the land surface and differing from adjacent genetically related layers in physical, chemical and biological properties or characteristics
Lithosols	Shallow soils with continuous hard rock within 100mm of the soil surface.
Particle(Fraction) distribution/size	The percentage of each size fraction into which a dispersed sample of a soil has been separated, i.e. sand silt and clay.
pH	The degree of acidity of a soil expressed in terms of the pH scale (1-14)
Soil profile	A vertical section of the soil through all its horizons and extending to the underlying material
Soil texture	The relative proportions or the various separates (san, clay silt) in the soil
Structure	The arrangement of primary soil particles into secondary units or peds, usually giving a distinctive characteristic pattern
Vertisols	Dark coloured soils with high clay content and one or more of: cracks wider than 100mm in the dry state, gilgai micro-relief, slickensides, wedge-shaped peds.



1.0 INTRODUCTION

Golder Associates Africa (Pty) Ltd. (hereafter 'Golder') was appointed by the Chinese National Offshore Oil Corporation (hereafter 'CNOOC') to undertake a baseline and ESIA for its proposed Oil production operations in the Albertine Rift Valley in Western Uganda. This report represents the Soil Impact Assessment Report for the Kingfisher Development Area and Pipeline route.

From Monday 13 January to Wednesday 22 January 2014 the Golder project team¹ conducted a baseline soil survey on the study area. The project team spent four days sampling on the shores of Lake Albert and two full days on the Pipeline to Kabaale.

This specialist study report includes the following sections:

- Section 2.0 details the objectives of the investigation;
- Section 3.0 outlines the scope of work;
- Section 4.0 presents the assumptions and limitations;
- Section 5.0 outlines the legislative and policy context;
- Section 6.0 presents the baseline soil environment;
- Section 7.0 details the assessment and rating of soil impacts;
- Section 8.0 outlines the environmental management plan/mitigation and monitoring measures;
- Section 9.0 presents the conclusions; and
- Section 10.0 lists the references used in compiling this report.

2.0 OBJECTIVES OF INVESTIGATION

The objectives of the investigation were:

- Classification and mapping soil types to scale 1:10,000;
- Wetland delineation (*if present*);
- Determine the effective depth of the soils;
- Assessment of the dry land and irrigation agricultural potential of the soils;
- Assessment of the erodibility of the soils (*i.e.* exchangeable sodium percentage exceeding 15% of the cation exchange capacity);
- Description of the relevant baseline environmental conditions relating to soils in the area of investigation;
- Assess the current land use and land capability;
- Description of chemical, physical and mineralogical properties of representative soil forms;
- Compilation of soil utilisation guide and plan (stripping & stockpiling); and
- Assessment of potential impacts on soil and surrounding environment during project development and mitigation thereof. Description of the anticipated positive and negative environmental impacts on soils,

¹ The project team, combined, have broad experience of soil surveys, geotechnical assessments, organic and inorganic soil pollution investigations, soil remediation and rehabilitation of gold slimes dams, coal discard dams, industrial organic and inorganic polluted areas, industrial effluent evaporation dams and footprints of gold slimes dams, principles & practise of environmental management and stabilisation of ecological sites that have been eroded naturally. They have undertaken numerous soil specialist studies in South Africa and across Africa and have been part of a number of several large multi-disciplinary projects, including environmental impact assessments, mine closure planning and rehabilitation of gold tailings, coal discard dumps and industrially polluted sites.





during the construction, operational and decommissioning phase. Description of how the negative environmental impacts will be managed and how the positive impacts will be maximised.

3.0 SCOPE OF WORK

In order to meet the objectives of the investigation the following scope of work was conducted:

3.1 Project meeting

An initiation meeting with project team was held to define and discuss study objectives and proposed scope of work.

3.2 Desktop review of relevant information

- The following documents, information and data were collected and reviewed to gain an understanding of the scope and context of the proposed project:
 - Golder Scoping Report and Spot 6 Satellite Data;
 - GPS coordinates, map defining study area plotted on 1:50,000 tif image, aerial and Google images;
 - Other ESIA's for the project area; and
 - Sources for FAO soil types in tropical regions.

3.3 Data collection

- An initial survey grid system was generated for the Kingfisher Development Area and Pipeline with 150 x 150m intervals with the aid of Base Camp GIS software. The reference points were transferred to a Global Positioning System (GPS), which would simplify in-field orientation. In order to utilise the available time in field optimally a new survey frequency had to be calibrated taking into consideration available time and access roads.
 - Kingfisher Development Area: 250 x 250m grid was established to assess 173ha/day for 519ha in three days. A total of 48 observation points were conducted at 30min/point (48 x 30 = 1,440min, 24h, 3 days @ 8h/day).
 - Pipeline: 150 x 150m grid was established to assess 70ha/day for 100ha in two days. A total of 20 observation points were conducted at 30min/point (20 x 30 = 600min, 10h, 1,25 days @ 8h/day).
- The soil survey was conducted during 13 to 22 January 2014 and was done according to standard soil survey techniques comprising of GPS referenced auger holes of both the Kingfisher Development Area and the Pipeline on a flexible grid to a depth of 1,8m (or to auger refusal). The soil observation points and exact GPS coordinates for the Kingfisher Development Area and Pipeline are attached in APPENDIX A and APPENDIX B respectively.
- Soil profile studies and classification was conducted according to the Food and Agricultural Organisation of the United Nations classification (FAO);
- Representative sampling of soils:
 - Kingfisher Development Area: 78 samples [57 (300mm), 13 (600mm), 8 (900mm)];
 - Pipeline: 16 samples [11 (300mm), 3 (600mm), 2 (900mm)];
- Analysis of the samples;
- Interpretation of analytical data and field observations;
- Compilation of draft report; and
- Internal review and submission of final report.





3.3.1 Sampling procedures

Soil sampling was carried out according to guidelines set out in Sparks, D. L. (1996):

- Auger holes were drilled with a 75mm diameter 1,8m mechanical steel auger;
The ground surface at the position of the auger hole was carefully cleared of loose material. When present, surface vegetation was carefully removed and the soil clinging to any roots left behind collected with the surface soil sample;
The sampling interval in the auger holes was 300mm and consolidated to a maximum of three samples per hole (300mm, 600mm and 900mm deep) a summary of which is attached in APPENDIX C;
The auger was advanced to the required depth and then carefully removed from the hole. The hole was covered to prevent foreign material from entering;
Approximately 1.5kg soil sample was taken from the augered holes raisings and soil material removed from the auger. The samples were quartered to produce a representative sample of suitable weight, i.e. 500g;
The soil samples were placed directly in zip-lock freezer bags, clearly labelled in indelible ink with the name of the site, auger hole number and sampling date;
The soil samples were stored in the shade prior to being transported to an air-conditioned environment awaiting transport to the analytical laboratory;
Chain of custody forms accompanied the soil samples to the laboratory and the samples were verified and signed for by the laboratory chemist; and
All auger hole logs were geo-referenced (GPS: datum WGS1984, decimal degrees).

3.3.2 Inorganic soil analysis

Table 1 shows the analytical parameters soil samples were analysed for by the Institute for Soil Climate and Water in Pretoria South Africa. The laboratory uses recognised standard methods and procedures and participates in local and international quality assurance quality control schemes (WEPAL, AgriLASA and CSIR for example). The following tests were conducted (and the results are attached in the appendices):

- 1) Chemical Analysis (APPENDIX D);
2) Particle size (APPENDIX E);
3) Exchangeable/extractable cations (APPENDIX F); and
4) Heavy Metals (APPENDIX G).

Table 1: Analytical soil properties

Table with 2 columns: ELEMENT and METHOD. Rows include CHEMICAL, Sample Preparation, pH (H2O), CEC+Ca+Mg+K+Na, EC+NO3, P, Zn+Cu+Co+Cr+Fe+Se+Ni+Pb+Cd+As+Hg+V+Mo+Sn+Ba+Al+Be+Ti+Mn+Br+Sr+In+Sb+Te+W+Pt+Tl+Bi+U+Cn+Li, and Lime Requirement.





MINERALOGY

Clay fraction (<0.002mm) identification	XRD-scan (6 treatments)
---	-------------------------

PHYSICAL

Particle size distribution (3 fractions-sand+silt+clay)	Hydrometer
---	------------

4.0 ASSUMPTIONS AND LIMITATIONS

The uncertainties considered within this assessment include:

- The initial survey grid of 150 x 150m for the Kingfisher Area had to be increased to 250 x 250m to fit into the planned field survey schedule; and
- The pipeline route of 100ha could only be served with 20 observation points within 2 days and if possible should be surveyed at a higher frequency.

5.0 LEGISLATIVE AND POLICY CONTEXT

The following standards and guidelines are relevant to soil management:

5.1 IFC Environmental, Health and Safety (EHS) guidelines

The Project is designed to meet regulatory requirements and commonly accepted international environmental, and social, and consultation standards. The standards are primarily guidelines and standards of the International Finance Corporation (IFC), a unit of the World Bank, which forms the de facto standards applied to many major operations seeking investments and guarantees from multilateral, bilateral and commercial financial institutions.

The guidelines and standards relevant to the soil study include the following:

- IFC's Performance Standards (PS) on IFC's General Environmental, Health, and Safety Guidelines (April 2007): Environmental Contaminated Land; and
- Performance Standard 3: Pollution Prevention and Abatement.

Contaminated lands may involve surface soils or subsurface soils that, through leaching and transport, may affect groundwater, surface water, and adjacent sites. Where subsurface contaminant sources include volatile substances, soil vapour may also become a transport and exposure medium, and create potential for contaminant infiltration of indoor air spaces of buildings.

In essence, where there is potential evidence of contamination at a site, the following steps are recommended by the standards:

- Contamination of land should be avoided by preventing or controlling the release of hazardous materials, hazardous wastes, or oil to the environment;
- When contamination of land is suspected or confirmed during any project phase, the cause of the uncontrolled release should be identified and corrected to avoid further releases and associated adverse impacts;
- Contaminated lands should be managed to avoid the risk to human health and ecological receptors. The preferred strategy for land decontamination is to reduce the level of contamination at the site while preventing the human exposure to contamination;
- Identification of the location of suspected highest level of contamination through a combination of visual and historical operation information;
- Sampling and testing of the contaminated media (soils or water) according to established methods applicable to suspected type of contaminant;





- Identifying the types of adverse effects that might result from exposure to the contaminants (e.g., effect on target organ, cancer, impaired growth or reproduction) in the absence of regulatory standards;
- Quantifying the magnitude of health risks to human and ecological receptors based on a quantitative analysis of contaminant exposure and toxicity (e.g. calculate lifetime cancer risk or ratios of estimated exposure rates compared to safe exposure rates) ;
- Determining how current and proposed future land use influence the predicted risks (e.g. change of land use from industrial to residential with more sensitive receptors such as children)
- Quantifying the potential environmental and/or human health risks from off-site contaminant migration (e.g. consider if leaching and groundwater transport, or surface water transport results in exposure at adjacent lands/receptors); and
- Determining if the risk is likely to remain stable, increase, or decrease with time in the absence of any remediation (e.g., consider if the contaminant is reasonably degradable and likely to remain in place, or be transported to other media).

Addressing these objectives provides a basis to develop and implement risk reduction measures (e.g., clean-up, on-site controls) for the site. If such a need exists, the following additional objectives become relevant:

- Determining where, and in what conceptual manner, risk reduction measures should be implemented;
- Identifying the preferred technologies (including engineering controls) needed to implement the conceptual risk reduction measures; and
- Developing a monitoring plan to ascertain whether risk reduction measures are effective.

The *General Guidelines* (April 2007) in the IFC EHS, contains specific provisions with respect to soil erosion and essence specify the need to reduce or prevent erosion and off-site sediment transport through appropriate reinstatement.

5.2 Ugandan soil legislation

The National Environment Minimum Standards for Management of Soil Quality Regulations 2001 set the legal framework for quality soil standards in Uganda.

5.2.1 Purpose

The main purpose of the legislation is to:

- Establish and prescribe minimum soil quality standards to maintain, restore and enhance the inherent productivity of the soil in the long term;
- Establish minimum standards for the management of the quality of soil for specified agricultural practices;
- Establish criteria and procedures for the measurement and determination of soil quality; and
- Issue measures and guidelines for soil management.

5.2.2 Schedules

The different schedules for soil quality parameters include:

- Rain-fed agriculture;
- Irrigated pastures;
- Wetland rice systems under natural flooding; and
- Wetland rice under irrigated systems.





5.2.3 Management of fragile soils

Emphasis is made on the management of the occurrence and management of acid sulphate soils. These soils are formed by oxidation of reduced sulphur compounds, exceeds the acid neutralising capacity of adsorbed bases and easily weatherable minerals to extent pH drops to below 4. Potential acid sulphate soils become acidic as a result of drainage because the reduced sulphur compound (Pyrite) is very unstable under aerobic conditions.

Pyritic papyrus peats are common in Uganda. Accumulation of ferrous mono sulphide (FeS) and ferrous disulphide (FeS₂) occur in a highly reducing environment. This process is prominent in the presence of mobile iron and abundance of organic material and conditions of a ready supply of sulphur.

Atmospheric and microbiological oxidation converts the iron sulphide into ferric acid, resulting in an extremely acid soil reaction, with pH well below 4.

Reclamation of acid sulphide soils requires 20-30 tonnes of lime per hectare.

5.2.4 Parameters for determination of soil quality

5.2.4.1 Chemical parameters

There is a variety of chemical soil parameters used for the management of soils:

- Soil Acidity (pH);
- Organic Matter;
- Sodicity (ESP);
- Salinity (EC);
- Cations Exchange Capacity (CEC),
- Exchangeable Bases;
- Phosphorus (P);
- Calcium Carbonate (CO₃); and
- Gypsum (CaSO₄).

5.2.4.2 Physical parameters

The following physical parameters are used for the management of soils:

- Texture;
- Structure;
- Coarse Fragments;
- Rooting Depth;
- Soil Depth;
- Drainage and depth to water table;
- Slope;
- Infiltration;
- Bulk Density;
- Total porosity; and



- Flooding.

5.2.4.3 Soil conservation measures and guidelines

Soils conservation is required as a basis for environmentally sound production of food, wood and other commodities based on sustainable use of land, species and ecosystem. In all these areas a combination of several conservation practices are recommended and options will depend on the area and crops/livestock/tree species of the land:

- Lowlands and flat areas (slopes up to 2%);
- Medium undulating to hilly topography (slopes up to 3 to 15%);
- Steep topography (slopes of 15% and above); and
- Pastures and rangelands.

6.0 BASELINE SOIL ENVIRONMENT

This section provides a brief overview of the soil baseline environment and context in which the proposed Project will take place:

6.1 Soil classification

These soils are described below and photographic examples depicted in Figure 1.

Figure 2 and Figure 3 shows the distribution of the different soils types identified and classified (according to the FAO Soil Classification System) within the Kingfisher Development Area and the Pipeline route.

Ferralsols: Soils with oxic B horizon. Mineral horizon at least 300mm thick with more than 15% clay. Little or no weathering primary aluminosilicates or 2:1 clay minerals, and no water dispersible clay. Typical properties are the presence of 1:1 clays, hydrated oxides of iron and aluminium, a low cation exchange capacity (<10cmol+/kg clay at pH7). The main processes of soil formation of oxisols are weathering, humification and pedoturbation due to animals. These processes produce the characteristic soil profile. They are defined as soils containing at all depths no more than 10 % weatherable minerals, and low cation exchange capacity. Oxisols are always a red or yellowish colour, due to the high concentration of iron(III) and aluminium oxides and hydroxides. In addition they also contain quartz and kaolin, plus small amounts of other clay minerals and organic matter.

Lithosols: Shallow soils with continuous hard rock within 100mm of soil surface. Soils that do not show any profile development other than an A horizon, has no diagnostic horizons, and most are basically unaltered from their parent material, which can be unconsolidated sediment or rock.

Vertisols: Dark coloured soils with high clay content, cracks wider than 100mm in dry state, gilgai micro-relief, slickensides, wedge-shaped peds. A high content of expansive clay known as montmorillonite that forms deep cracks in drier seasons or years. Alternate shrinking and swelling causes self-mulching, where the soil material consistently mixes itself, causing vertisols to have an extremely deep A horizon and no B horizon. Vertisols typically form from highly basic rocks, such as basalt, in climates that are seasonally humid or subject to erratic droughts and floods, or to impeded drainage. Depending on the parent material and the climate, they can range from grey or red to the more familiar deep black. The shrinking and swelling of vertisols can damage buildings and roads, leading to extensive subsidence.

Gleysols: Wet soils formed in unconsolidated materials. A Gleysol in the FAO World Reference Base for Soil Resources is a wetland soil (hydric soil) that, unless drained, is saturated with groundwater for long enough periods to develop a characteristic gleyic colour pattern. This pattern is essentially made up of reddish, brownish or yellowish colours at surfaces of soil particles (peds) and/or in the upper soil horizons mixed with greyish/blueish colours inside the peds and/or deeper in the soil.

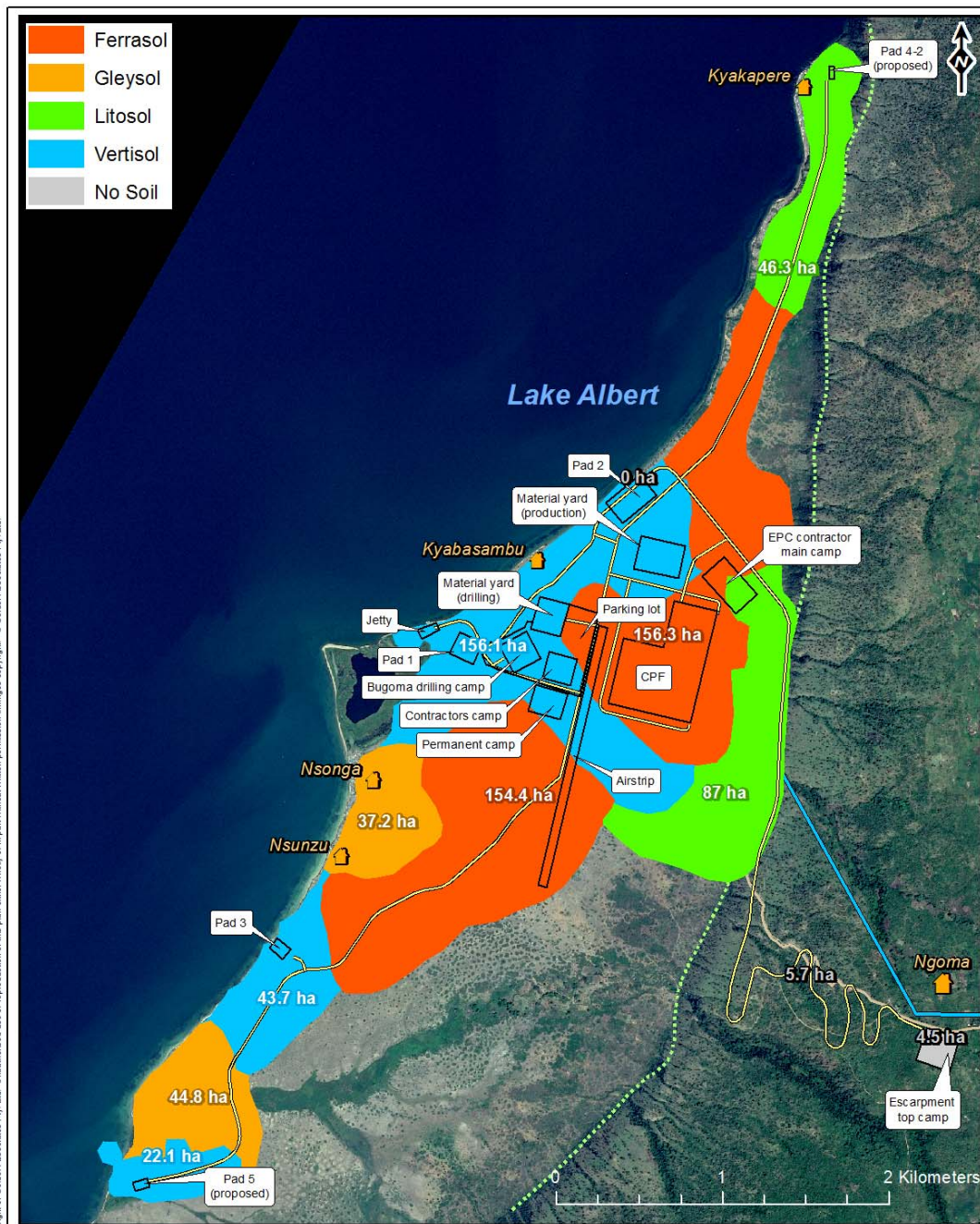



Figure 1: Examples of FAO classified soils (from left to right) - Ferralsol, Lithosol, Vertisol and Gleysol.



SOIL IMPACT ASSESSMENT



Information contained on this drawing is the copyright of Golder Associates Pty. Ltd. Unauthorised use or reproduction of this plan, either wholly or in part without written permission infringes copyright. © Golder Associates Pty. Ltd.

LEGEND		RESOURCES/NOTES																																					
Villages	Site layout	<table border="1"> <tr> <td colspan="2">PROJECT</td> <td colspan="2">13615730 CNOOC</td> </tr> <tr> <td colspan="2">TITLE</td> <td colspan="2">SOIL TYPES AND INFRASTRUCTURE</td> </tr> <tr> <td> New in-roads</td> <td> Existing roads</td> <td colspan="2">PROJECT No. 13615730</td> </tr> <tr> <td> Pipeline to Kabaale (new)</td> <td></td> <td>GIS</td> <td>CAA 14/07/2014</td> </tr> <tr> <td></td> <td></td> <td>CHECK</td> <td>AB 14/07/2014</td> </tr> <tr> <td></td> <td></td> <td>REVIEW</td> <td>NS 14/07/2014</td> </tr> <tr> <td></td> <td></td> <td></td> <td>SCALE 1:30 000</td> </tr> <tr> <td></td> <td></td> <td></td> <td>A4</td> </tr> <tr> <td></td> <td></td> <td></td> <td>REV 0</td> </tr> </table>		PROJECT		13615730 CNOOC		TITLE		SOIL TYPES AND INFRASTRUCTURE		New in-roads	Existing roads	PROJECT No. 13615730		Pipeline to Kabaale (new)		GIS	CAA 14/07/2014			CHECK	AB 14/07/2014			REVIEW	NS 14/07/2014				SCALE 1:30 000				A4				REV 0
PROJECT				13615730 CNOOC																																			
TITLE				SOIL TYPES AND INFRASTRUCTURE																																			
New in-roads	Existing roads			PROJECT No. 13615730																																			
Pipeline to Kabaale (new)		GIS	CAA 14/07/2014																																				
		CHECK	AB 14/07/2014																																				
		REVIEW	NS 14/07/2014																																				
			SCALE 1:30 000																																				
			A4																																				
			REV 0																																				
		REFERENCE																																					
		PROJECTION																																					

K:\GIS\GIS Projects\13615730_CNOOC\XData\Soil types and infrastructure Kingfisher.mxd

Figure 2: Soil types at the Kingfisher Development Area.



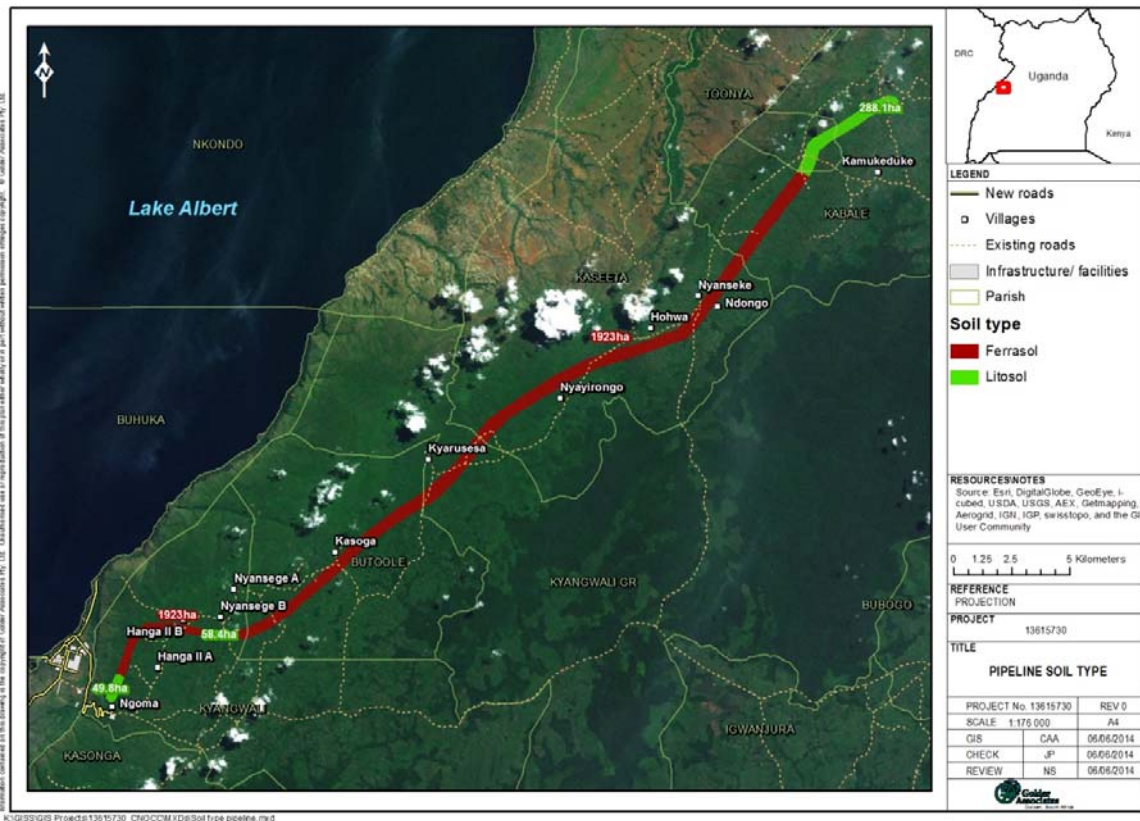

Figure 3: Soil types along the Pipeline route

6.2 Agricultural potential

The agricultural potential for the various soil types for the production of maize (as an example) was assessed using the following formula as a function of various variables:

$$YIELD (kg ha^{-1}) = R/B \times ED/A \times C \times X$$

R – Rainfall (mm);

B - Species growth characteristics factor;

ED - Effective depth of the soil;

A - Soil wetness factor for textural classes of soil above effective depth;

C - Correction factor for aeration of soil; and

X - Fixed coefficient for species.

The main variables determining the soil’s agricultural potential includes the **average rainfall** (mm), **soil depth** (mm) and **water management & holding capacity**. The yield estimates in Table 2 excludes any other management practices, *i.e.* fertilisation, cultivar, plant density, *etc.* that can make a significant difference in yield.





Table 2: Agricultural potential of soils

SOIL TYPE	AGRICULTURAL POTENTIAL	
	DRY LAND	IRRIGATION
Ferrasols	High	High
Gleysols	Low	Low
Lithosols	Low	Low
Vertisols	Low	Medium

The Ferrasols have high agricultural potential under dryland (700-1,400mm) and irrigation condition (>10-15mm/week 33 – 1,500kPa plant available water). However, the main constraint for optimum production is the availability of water for irrigation purposes. Production under dryland conditions of 30,000 plants/ha with average rainfall 450mm/year will not be sustainable, especially during the summer period with extreme heat units. Production under irrigation conditions would require 6,100m³/ha/year available water for 100,000 plants/ha (the planting density is increased under irrigation). Water quality is another factor to be considered to be sufficient for irrigation purposes. Lithosols are not suitable for agricultural purposes, and consideration should be given not to risk agriculture on the Gleysols soils due to marginal potential yields under dryland conditions.

6.3 Land use

Land use can be defined as the arrangements, activities and inputs people undertake in a certain land cover type to produce, change or maintain, *i.e.* the human use of land. Land use involves the management and modification of natural environment or wilderness into built environment such as settlements and semi-natural habitats such as dams, infrastructure, natural grassland, pans, ploughed land, settlements, wetlands, pastures, and managed woods.

Figure 4 and Figure 5 presents the current land use at the Kingfisher Development Area and Pipeline route respectively and distinguishes between:

- CNOOC base and airstrip;
- Natural grassland;
- Wetland;
- Cultivated land; and
- Village.



SOIL IMPACT ASSESSMENT

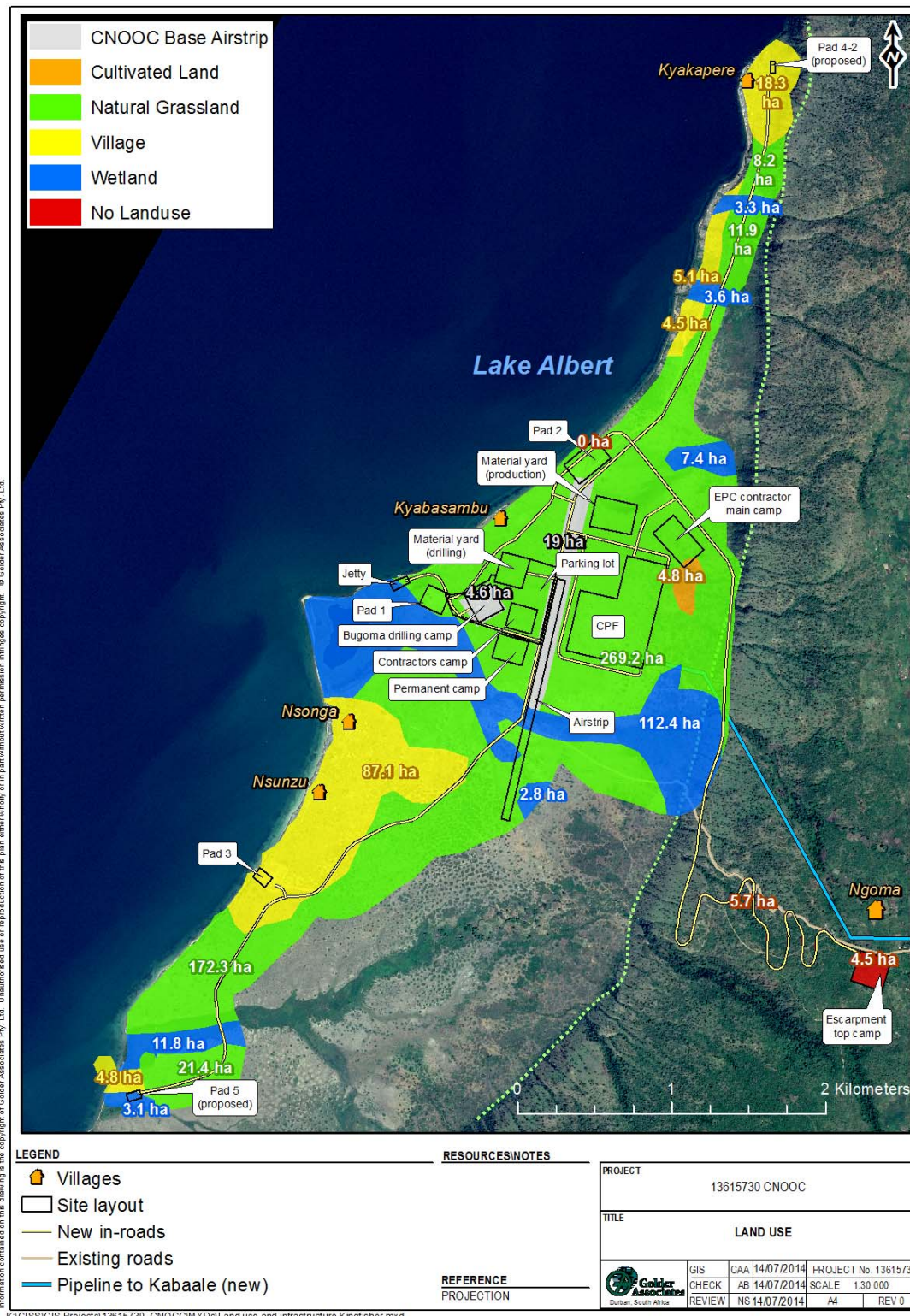

Figure 4: Land use at the Kingfisher Development Area.





SOIL IMPACT ASSESSMENT

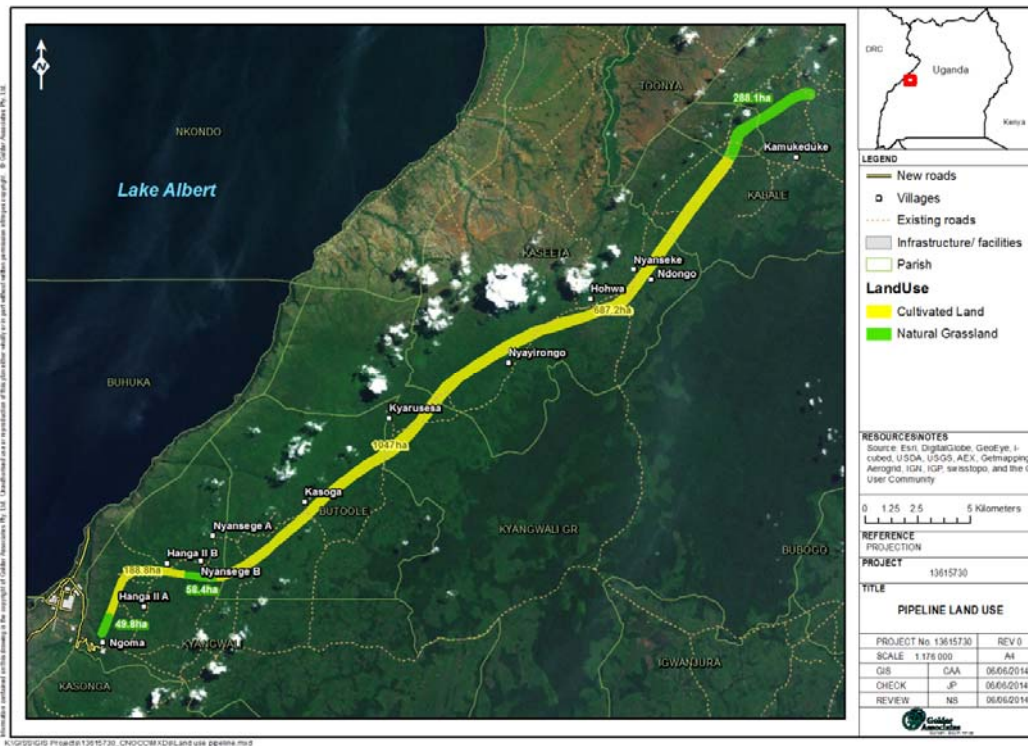

Figure 5: Land use along the Pipeline route.

Table 3 summarises the land use of the areas investigated:

Table 3: Land use at the Kingfisher Development Area and Pipeline route

Area	Land Use	Surface Area (ha)	% of Total
Kingfisher Area	CNOOC Base & Airstrip	24	3,16
	Natural Grassland	468	61,57
	Cultivated Land	5	0,66
	Villages and immediate surrounds	120	15,79
	Wetlands	143	18,82
	Total		760
Pipeline Route	Natural Grassland	396	17
	Cultivated Land	1,923	83
	Total	2,319	100

The current land use on the Kingfisher Development Area is shown in Figure 6.

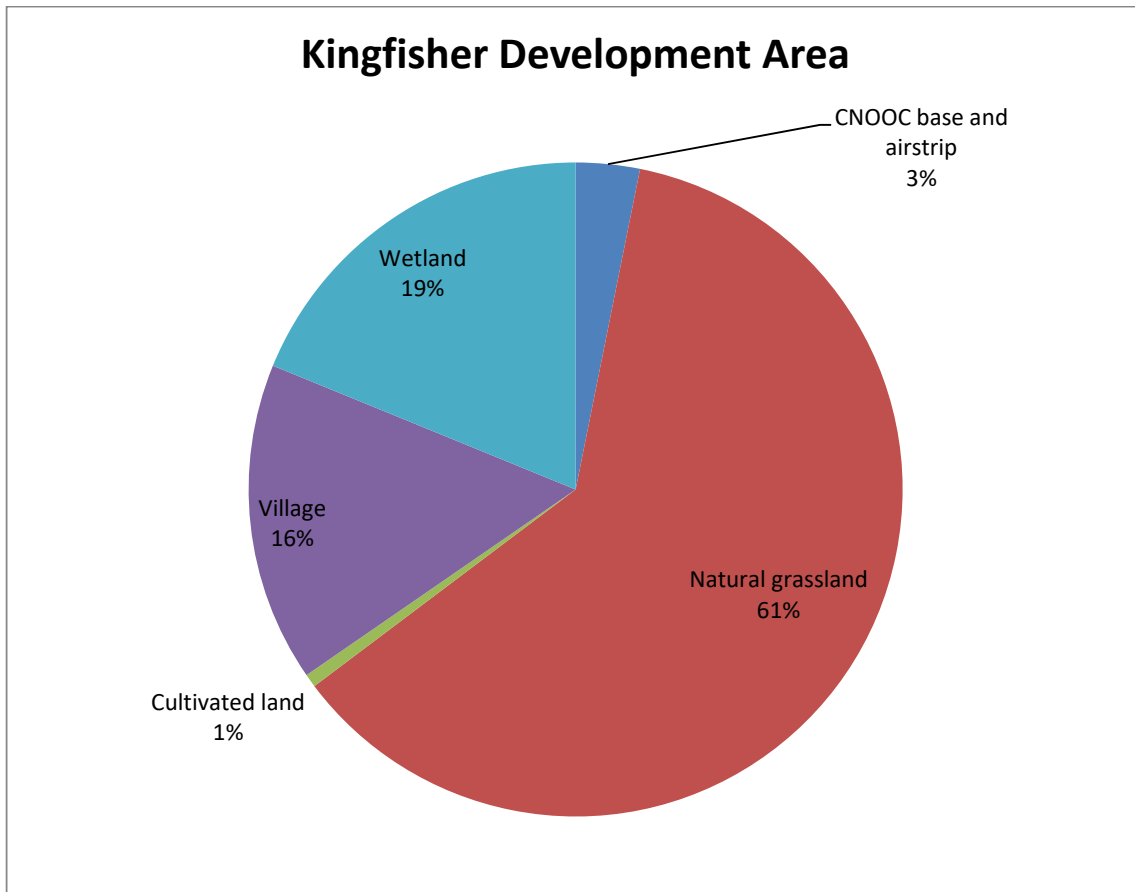

Figure 6: Current land use of Kingfisher Development Area

The current land use of the Pipeline route is estimated in Figure 7.

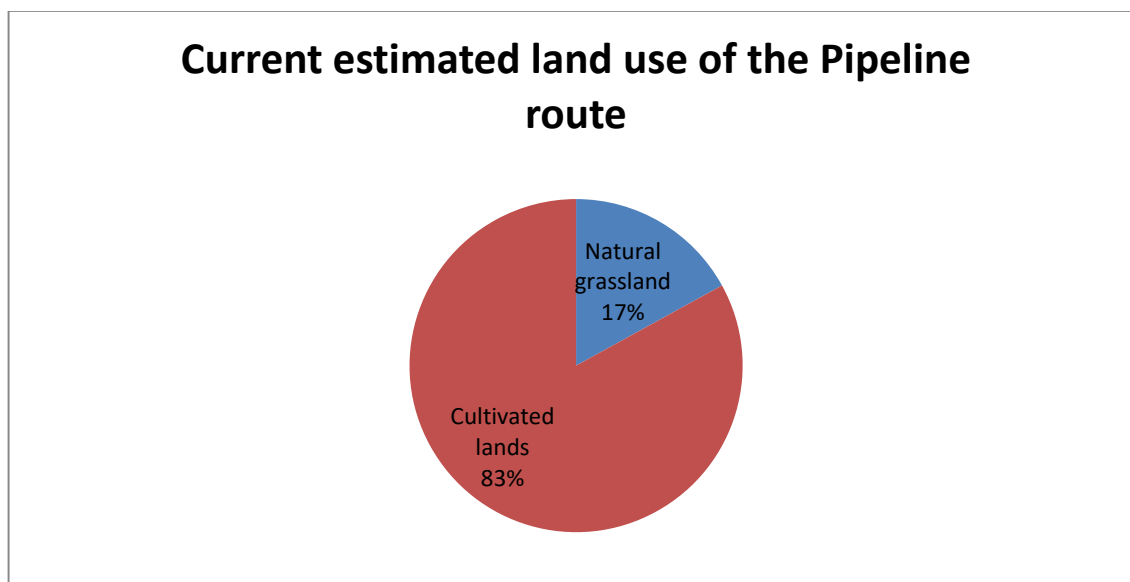

Figure 7: Estimated land use of the Pipeline route





6.4 Land capability

Land capability classification (Table 4) shows the suitability of soils for most kinds of field crops. Crops that require special management are excluded. In general soils are grouped according to their limitations for field crops, the risk of damage if they are used for crops, and the way they respond to management.

Table 4: Criteria for determination of land capability

Classification	Description
Wetland, Pans	Land with organic soils or supporting hygrophilous vegetation where soil and vegetation processes are water determined.
Arable (>600mm)	Land that does not qualify as wetland. Soil is readily permeable to depth of 750mm. Soil has pH value between 4 and 8.4. Soil has low salinity and SAR. Soil has less than 10% (by volume) rocks or pedocrete fragments larger than 100mm in the upper 750mm. Has a slope (%) and erodibility factor (k) such that their product is <2.0. Occurs under a climate of crop yields that are at least equal to the current national average for these crops.
Grazing (250 – 600mm)	Land which does not qualify as wetland or arable land. Has soil, or soil-like material, permeable to roots of native plants, that is more than 250mm thick and contains less than 50% by volume of rocks or pedocrete fragments larger than 100mm. Supports, or is capable of supporting a stand of native or introduced grass species or other forage plants used by domesticated livestock or game animals on a commercial basis.
Wilderness (<250mm)	Land which does not qualify as wetland, arable or grazing land.

Table 5, Figure 8 and Figure 9 summarises the land capability of the areas investigated and these are also displayed in Figure 10 (Kingfisher Development Area) and Figure 11 (Pipeline route).

Table 5: Land capability of the Kingfisher Development Area and Pipeline route

Area	Land Capability	Surface Area (ha)	% of Total
Kingfisher Area	Arable	429	56
	Wetland	144	19
	Wilderness	187	25
	Total	760	100
Pipeline Route	Arable	1,922	83
	Grazing	396	17
	Total	2,319	100



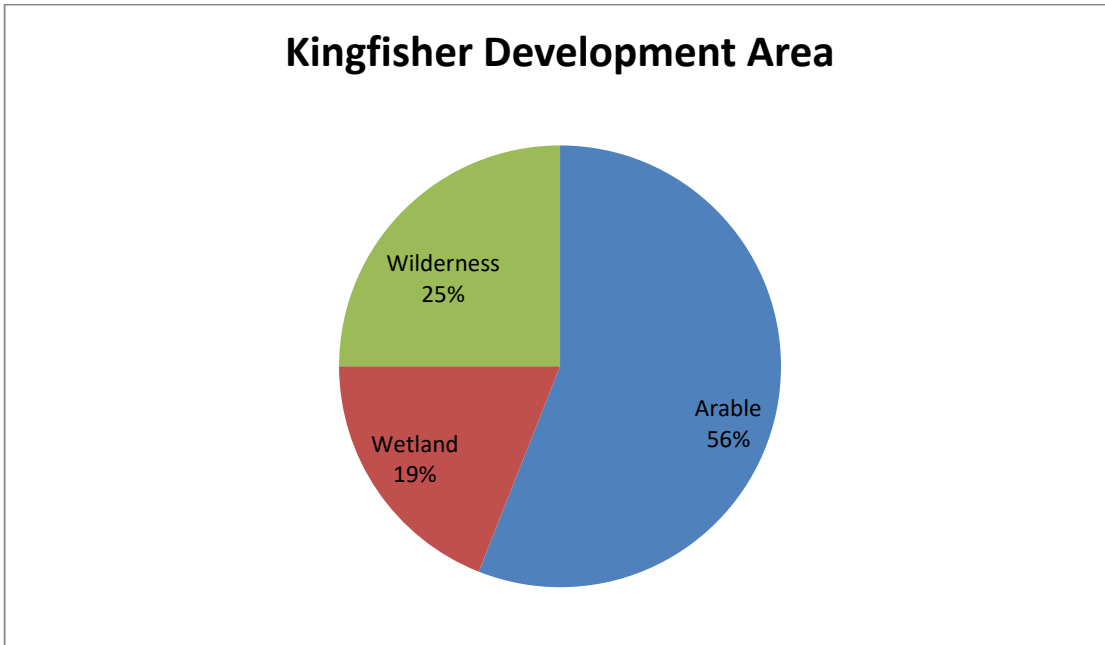

Figure 8: Land capability of Kingfisher Development Area.

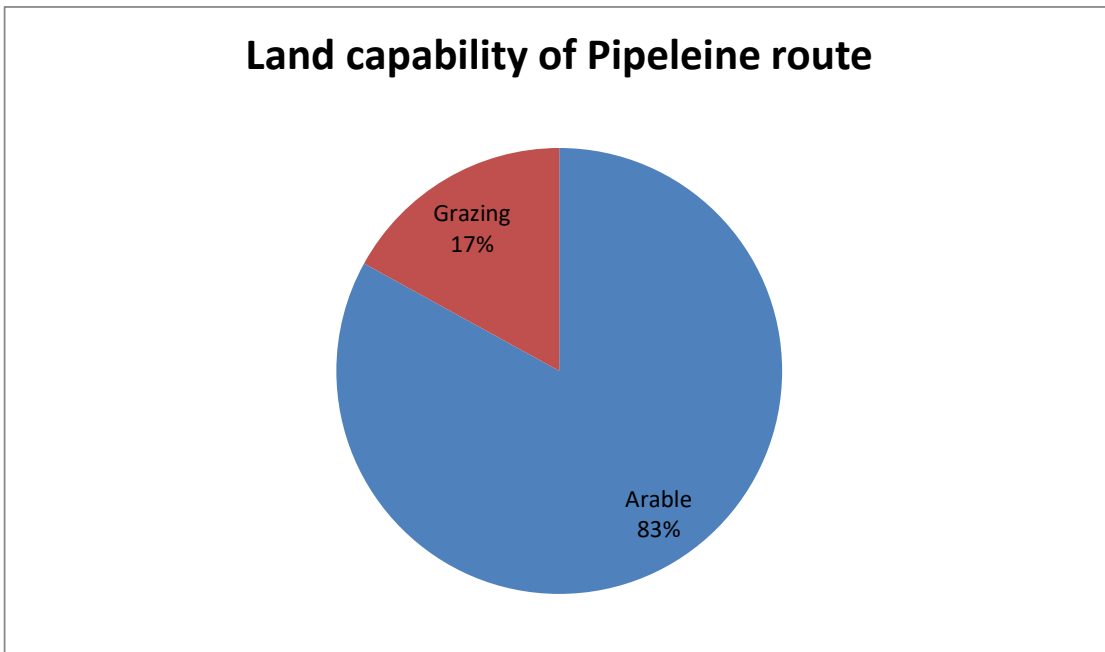
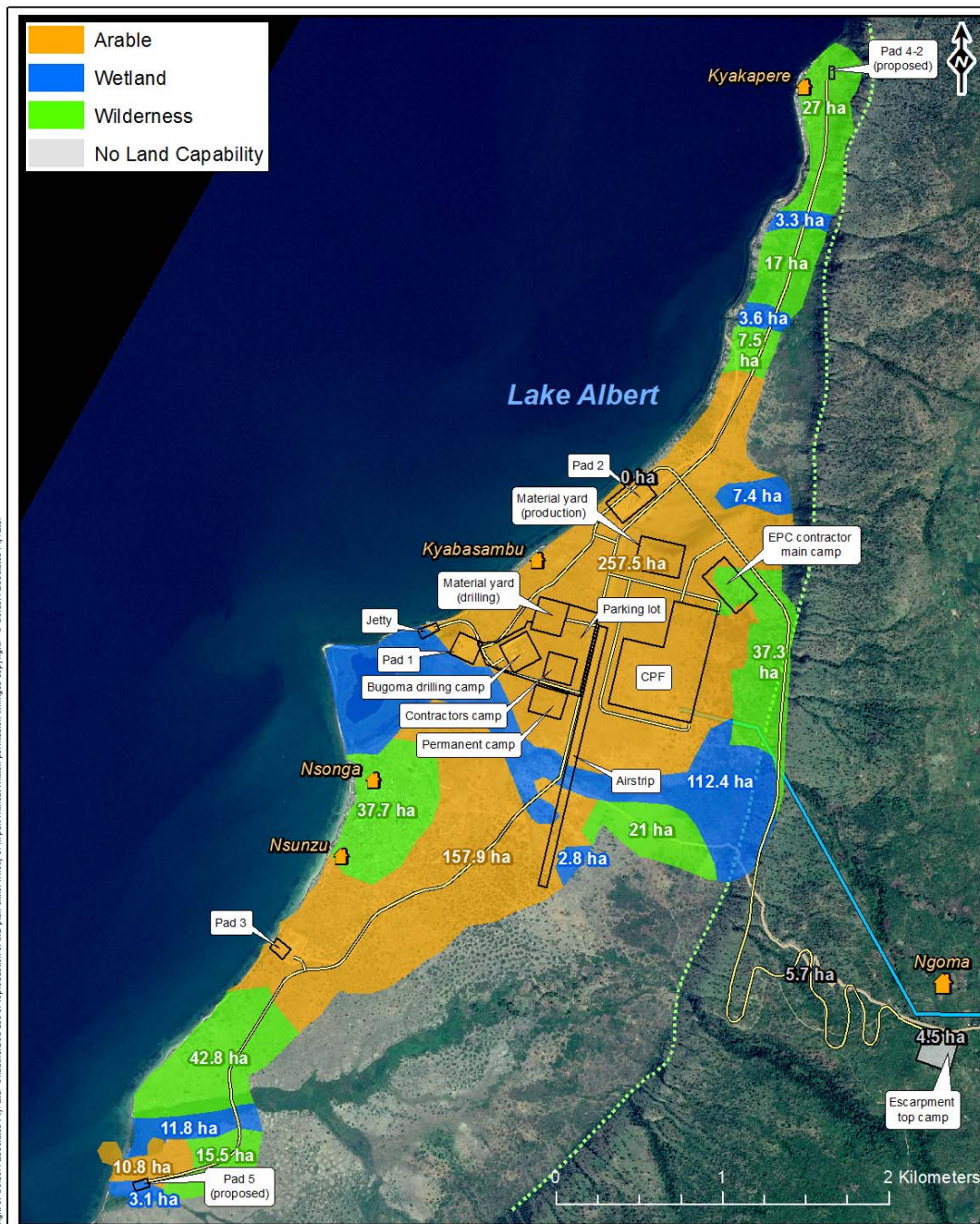

Figure 9: Land capability of Pipeline route.





SOIL IMPACT ASSESSMENT



Information contained on this drawing is the copyright of Golder Associates Pty. Ltd. Unauthorised use or reproduction of this plan, either wholly or in part without written permission infringes copyright. © Golder Associates Pty. Ltd.

LEGEND		RESOURCES/NOTES	
	Villages		
	Site layout		
	New in-roads		
	Existing roads		
	Pipeline to Kabaale (new)		
		REFERENCE	
		PROJECTION	
		PROJECT	
		13615730 CNOOC	
		TITLE	
		LAND CAPABILITY	
		PROJECT No. 13615730	
		SCALE 1:30 000	
		REV 0	

Figure 10: Land capability at Kingfisher Development Area.



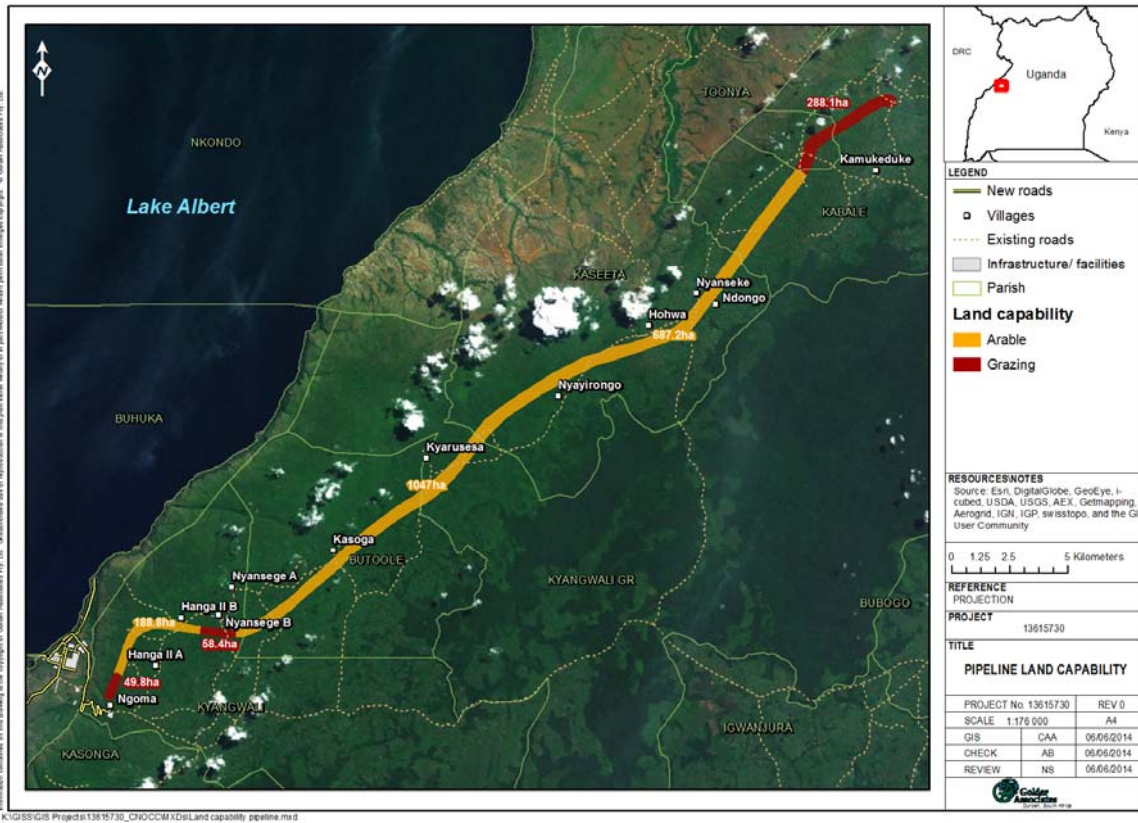

Figure 11: Land capability along the Pipeline route.

6.5 Erodibility of soils and evidence of misuse

6.5.1 Chemical mechanism

The soils have a cation exchange capacity to adsorb cations to neutralise electrical charges on the exchange sites of the clay minerals. The clay minerals are the fraction smaller than 0,002mm and would be presented by 1:1 & 2:1 layer silicates, i.e. kaolinite and smectite respectively. The exchange sites are usually occupied by Ca, Mg, K, Na and/or heavy metals in solution around the clays and if Na occupies more than 15% of the cation exchange capacity it would result in dispersion of the clays due to hydration of the Na on the exchange sites causing the double layer around the clays to swell (Figure 12).



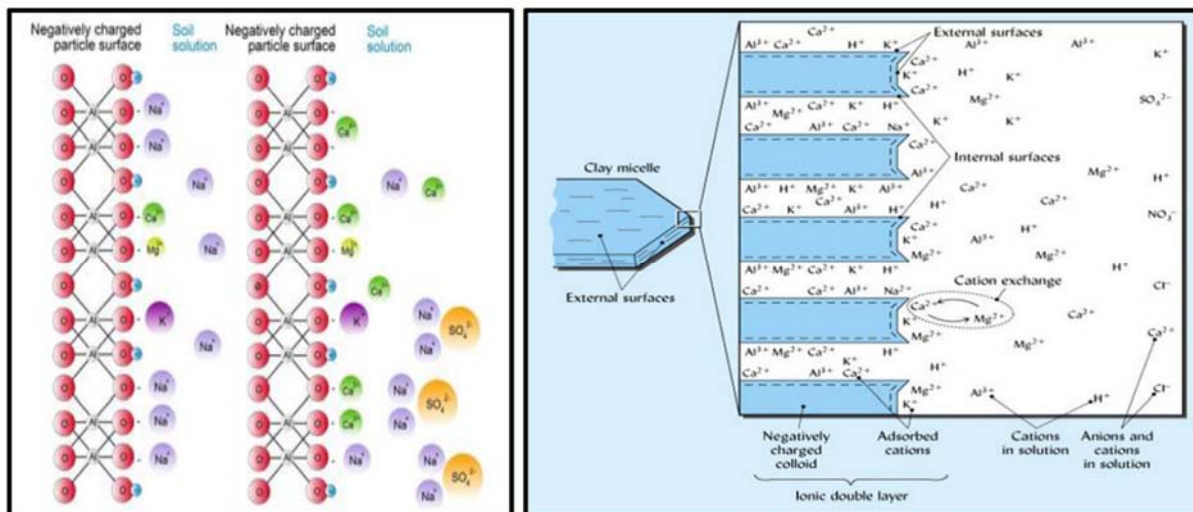

Figure 12: Exchangeable sodium molecules on exchange sites of clay surfaces as percentage of cation exchange capacity.

6.5.2 Situational analyses

The exchangeable sodium percentage (Figure 12) of the soils analysed on the Kingfisher Development Area and Pipeline route is below 15% of the cation exchange capacity, rendering the soils free of dispersion anomalies caused by the hydration of sodium and consequent soil erosion.

However, on the Kingfisher Development Area soil erosion of mainly Vertisols and Gleysols on the shore line was evident (Figure 13). The occurrence of this erosion is mainly due to improper water control measures that could have been prevented by correctly designed civil construction methods and techniques. Within the context of the Ugandan Environmental Minimum Standards for Management of Soil Quality Regulations 2001 soil conservation is required as a basis for environmental sound production of food based on sustainable use of land, species and ecosystems. A combination of several conservation practices are recommended for the following scenarios:

- Lowlands and flat areas (slopes up to 2%);
- Undulating to hilly topography (slopes 3 – 15%);
- Steep topography (slopes 15% and above);
- Pastures and range lands.

Lowlands, *i.e.* the Kingfisher Development Area, are the alluvial plains and the bottom lands of small tributaries in a catchment. Surface and/or sub-surface drainage and interception and diversion ditches are crucial prerequisites to minimise erosion taking place.





Figure 13: Evidence of soil erosion at the Kingfisher Development Area

6.6 Overview of soil chemical, physical and mineralogical properties

The soils are characterised by neutral pH values (5,3 and 7,2) and low electrical conductivity values (<250mS/m). Under these conditions plant available nitrogen (15-20mg/kg), phosphorus (10-15mg/kg) and potassium (>50mg/kg) are readily available for plant uptake and sustainable plant growth. No irregular anomalies (Figure 14) occur in any one of the different soil types.

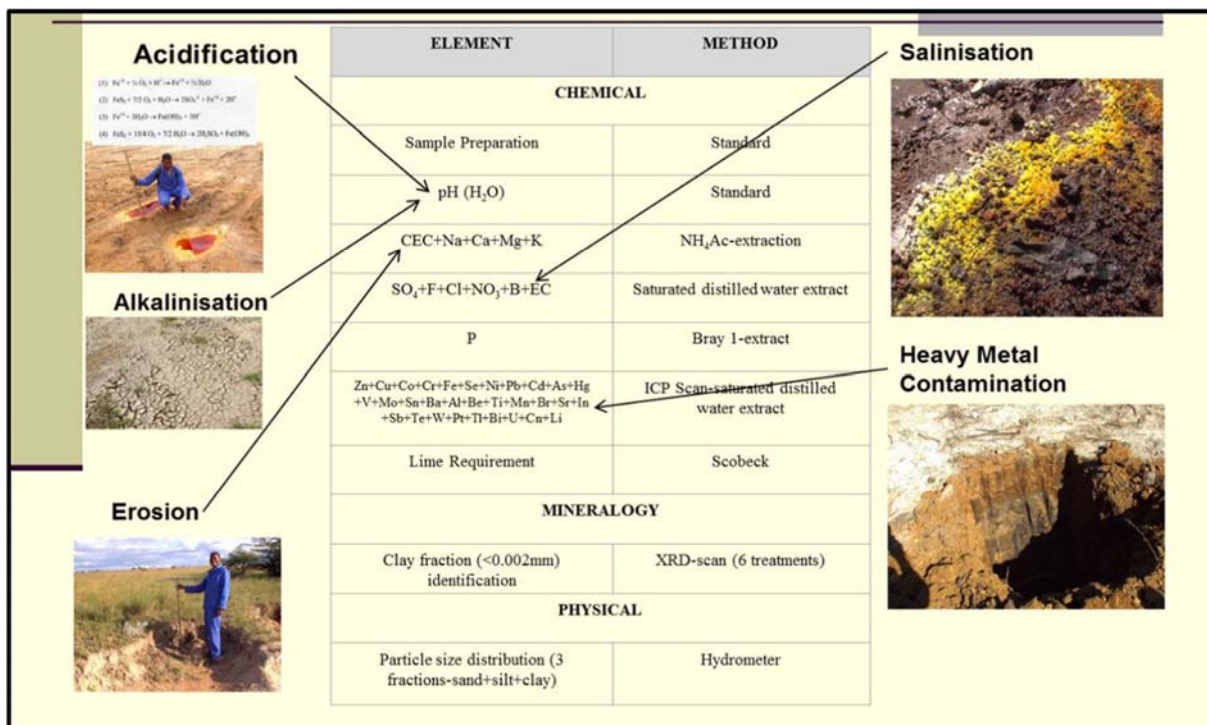

Figure 14: Potential soil chemical, physical and mineralogical anomalies.

The Ferrasols and Lithosols are typically characterised by a low dense structure and texture distribution of approximately 65% sand, 20% silt and 15% clay with drainage properties in order of 10mm/h. The Vertisols and Gleysols have a high dense structure and texture distribution of approximately 75% clay, 10% silt and





15% sand. The dominant clay mineral in the Ferrasols and Lithosols is kaolinite (*1:1 layer silicate*), with a low buffer capacity due to the low cation exchange capacity ($<10\text{cmol+}/\text{kg}$). The Vertisols and Gleysols contain 2:1 layer silicates, *i.e.* smectite with high buffer capacity ($>10\text{cmol+}/\text{kg}$) (Figure 15).

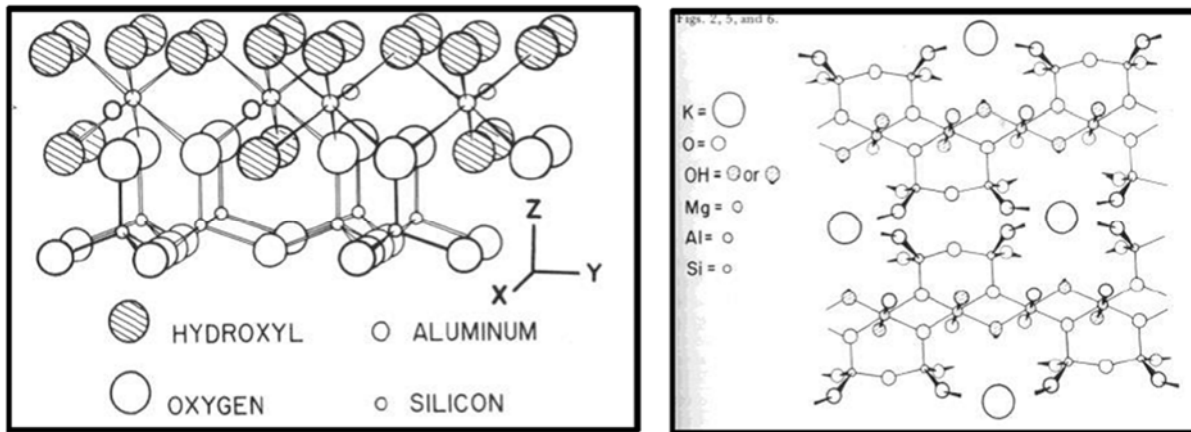

Figure 15: 1:1 (left) and 2:1 (right) clay mineral.

6.7 Assessment of suitability of soils for rehabilitation purposes

The soil horizons of the Ferrasols, Vertisols and Gleysols are suitable for rehabilitation purposes to establish a vegetated free flow drainage system (Figure 16).

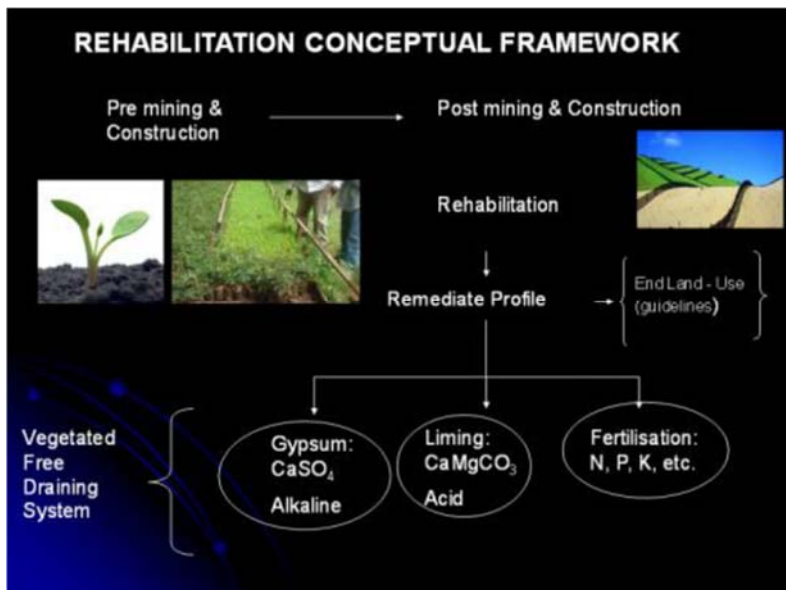

Figure 16: Conceptual Rehabilitation Framework.

When stockpiled soils have been replaced during rehabilitation, the soil fertility should be assessed to determine the level of fertilisation required to sustain normal plant growth. The fertility remediation requirements need to be verified at the time of rehabilitation. The topsoil should be uniformly spread onto the rehabilitated areas and care should be taken to minimise compaction that would result in soil loss and poor root penetration.



When returning the soil to the rehabilitation site care should be taken to place soil in a manner that will allow for levelling of soil to take place in a single pass. The soil profile should not be built up using a repeated tipping and levelling action to increase the soil depth.

Proper water control measures should be implemented to ensure a free draining rehabilitated landscape. Surveying the area to be rehabilitated and generating a digital terrain map preferential seepage pathways should be identified and contoured to prevent surface runoff creating erosion during a 1:10 rainstorm event with 20mm/h rainfall intensity. A soil scientist with remediation and rehabilitation experience should be consulted to assess water retention and storage abilities of soil types to utilise the net cascading effect of water storage under saturated and unsaturated flow conditions.

6.8 Soil conditions at different infrastructures

6.8.1 Soil types

Figure 16 illustrates the different soil types associated with the infrastructure on the Kingfisher Plain and is summarised Table 6:



SOIL IMPACT ASSESSMENT

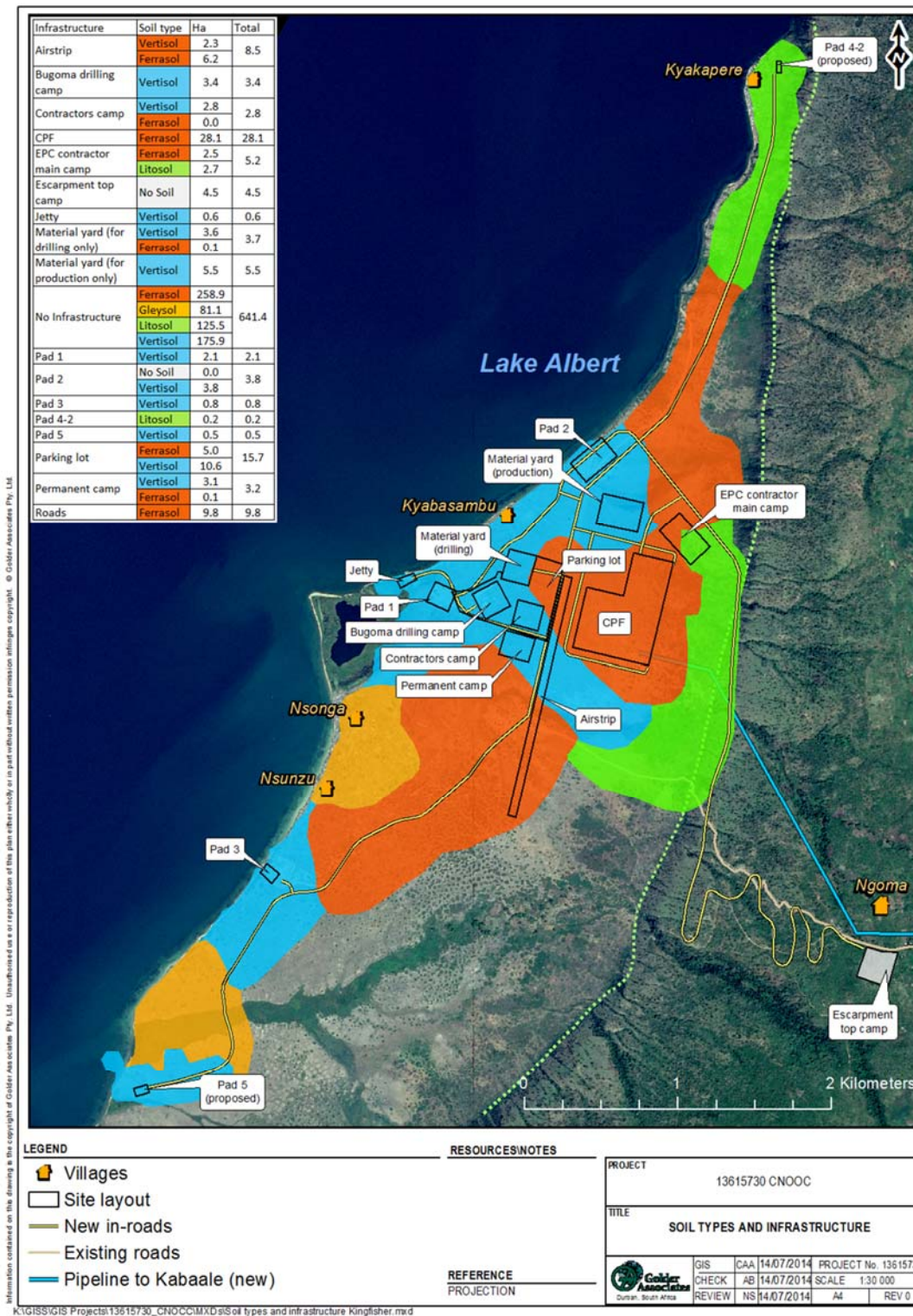

Figure 17: Soil types at the Kingfisher Development Area infrastructure.





Table 6: Summary of soil types at Kingfisher Development Area infrastructure.

Infrastructure	Soil Type	Agricultural Potential		Ha
		Dryland	Irrigation	
Airstrip	Vertisol	Low	Medium	2,28
	Ferrasol	High	High	6,21
Bugoma Drilling Camp	Vertisol	Low	Medium	3,42
Contractors Camp	Vertisol	Low	Medium	2,80
CPF	Ferrasol	High	High	28,06
EPC Contractor Main Camp	Ferrasol	High	High	2,48
	Lithosol	Low	Low	2,74
Jetty	Vertisol	Low	Medium	0,59
Material Yard Drilling	Vertisol	Low	Medium	3,58
	Ferrasol	High	High	0,12
Material Yard Production	Vertisol	Low	Medium	5,48
Pad 1	Vertisol	Low	Medium	2,14
Pad 2	Vertisol	Low	Medium	3,80
Pad 3	Vertisol	Low	Medium	0,78
Pad 4-2	Lithosol	Low	Low	0,22
Pad 5	Vertisol	Low	Medium	0,48
Parking Lot	Ferrasol	High	High	5,04
	Vertisol	Low	Medium	10,63
Permanent Camp	Vertisol	Low	Medium	3,15
	Ferrasol	High	High	0,07
Roads	Ferrasol	High	High	9,83
	Gleysol	Low	Low	0,19
	Lithosol	Low	Low	3,16
	Vertisol	Low	Medium	9,47

6.8.2 Land use

Figure 18 illustrates the land use associated with the infrastructure on the Kingfisher Plain and is summarised Table 7:





SOIL IMPACT ASSESSMENT

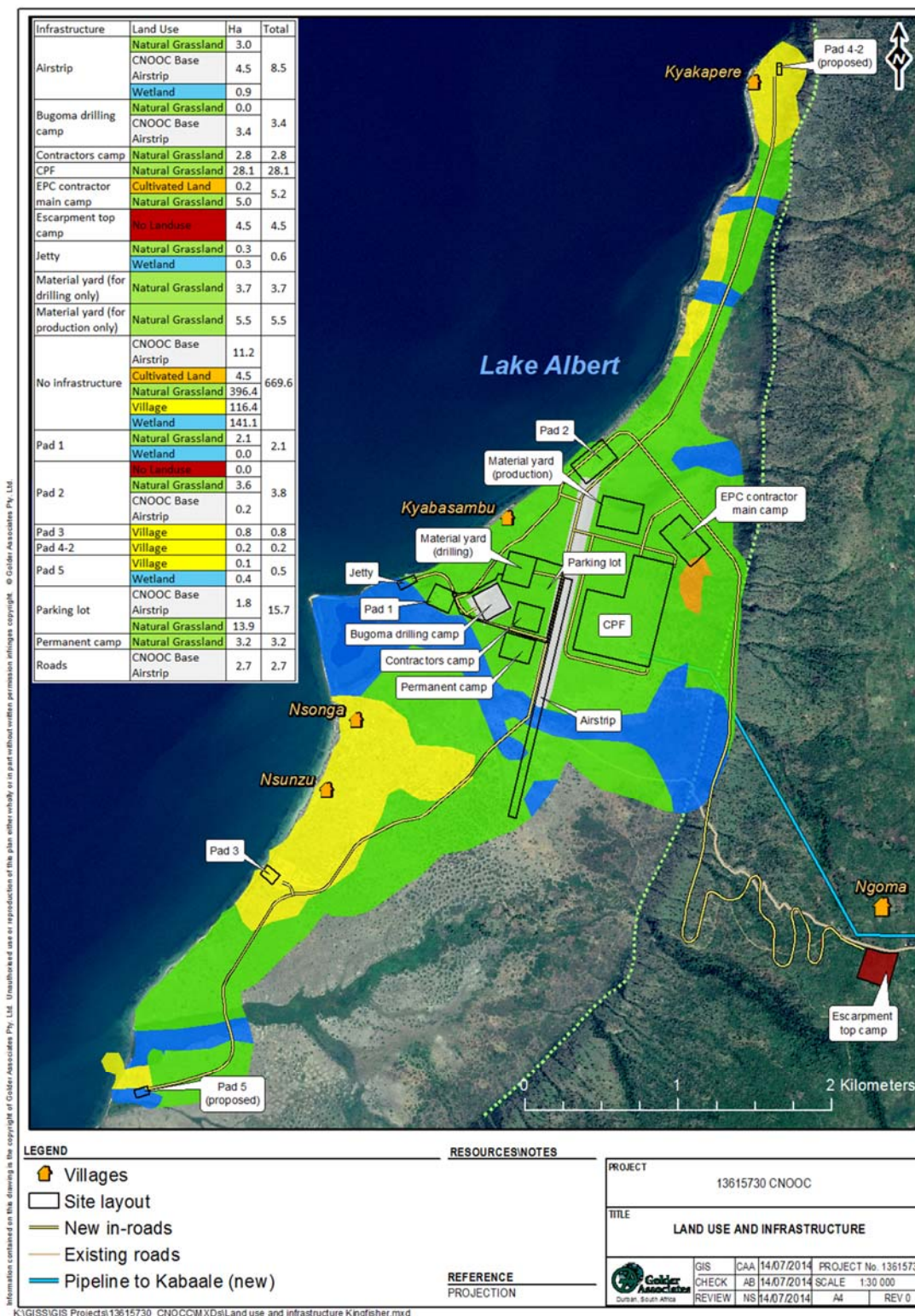

Figure 18: Land use at Kingfisher Development Area infrastructure.





Table 7: Summary of land use at Kingfisher Development Area infrastructure.

Infrastructure	Land Use	Ha
Airstrip	Natural grassland	3,04
	Wetland	0,93
Bugoma Drilling Camp	Natural grassland	0,02
Contractors Camp	Natural grassland	2,80
CPF	Natural grassland	28,06
EPC Contractors Main Camp	Cultivated land	0,23
	Natural grass	4,98
Jetty	Natural grassland	0,25
	Wetland	0,34
Material Yard Drilling	Natural grassland	3,70
Material Yard Production	Natural grassland	5,48
Pad 1	Natural grassland	2,14
	Wetland	0,01
Pad 2	Natural grassland	3,63
Pad 3	Village	0,78
Pad 4-2	Village	0,22
Pad 5	Village	0,06
	Wetland	0,41
Parking Lot	Natural grassland	13,89
Permanent Camp	Natural grassland	3,22
Roads	CNOOC Base Airstrip	2.70

6.8.3 Land capability

Figure 19 illustrates the land capability associated with the infrastructure on the Kingfisher Plain and is summarised Table 8:



SOIL IMPACT ASSESSMENT

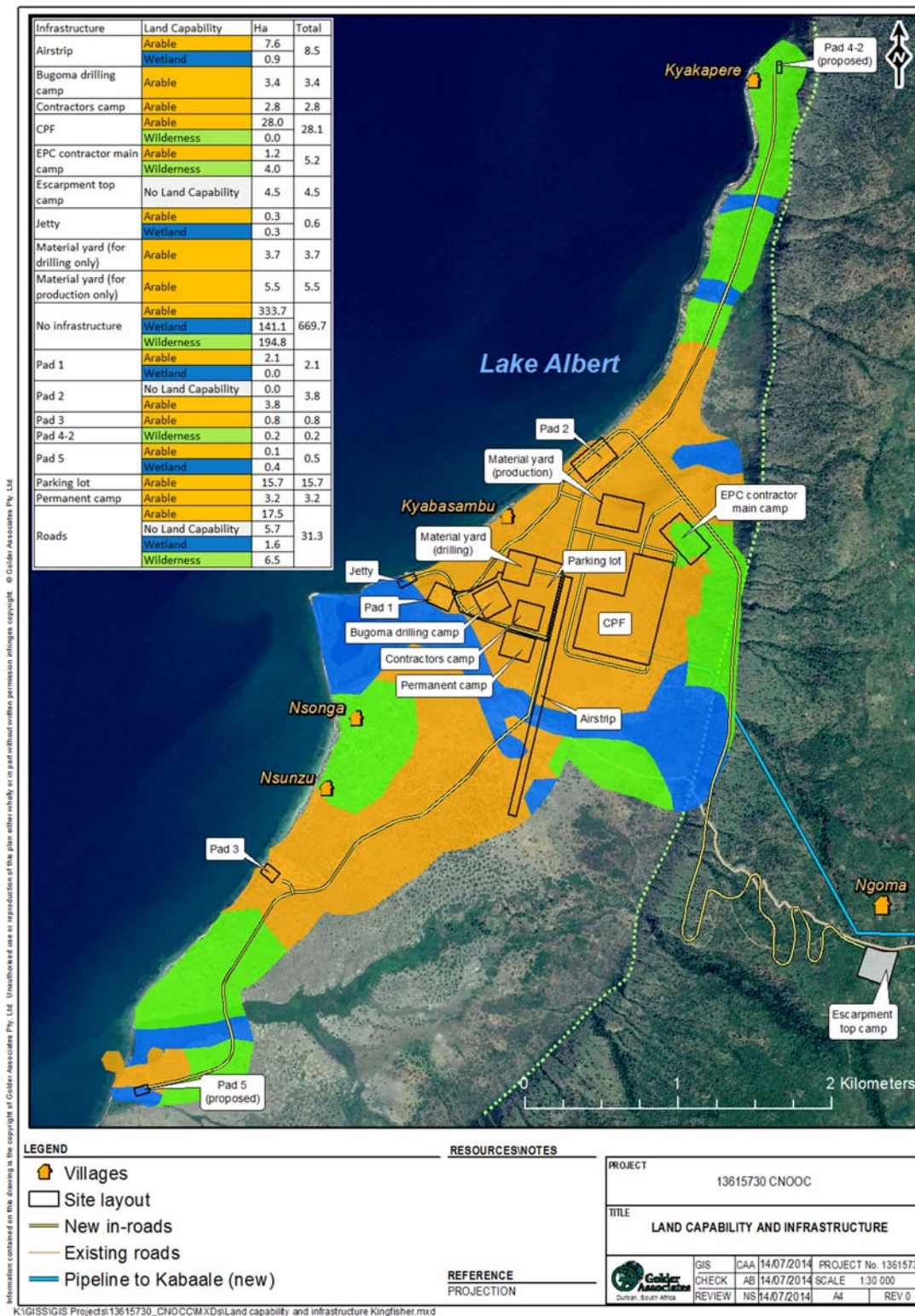

Figure 19: Land capability at Kingfisher Development Area infrastructure.





Table 8: Land capability at Kingfisher Development Area infrastructure.

Infrastructure	Land Use	Ha
Airstrip	Arable	7,57
	Wetland	0,93
Bugoma Drilling Camp	Arable	3,42
Contractors Camp	Arable	2,80
CPF	Arable	28,02
	Wilderness	0,04
EPC Contractors Main Camp	Arable	1,18
	Wilderness	4,03
Jetty	Arable	0,25
	Wetland	0,34
Material Yard Drilling	Arable	3,70
Material Yard Production	Arable	5,48
Pad 1	Arable	2,14
	Wetland	0,01
Pad 2	Arable	3,80
Pad 3	Arable	0,78
Pad 4-2	Wilderness	0,22
Pad 5	Arable	0,06
	Wetland	0,41
Parking Lot	Arable	15,67
Permanent Camp	Arable	3,22
Roads	Arable	17,46
	Wetland	1,40
	Wilderness	3,81

6.9 Soil conditions along infield roads

The soil types, land use and land capability of the planned infield roads (15m wide) at the Kingfisher Development Area are presented in the figures in Sections 6.8.1, 6.8.2 and 6.8.3 above and summarised in Table 9:

Table 9: Soil types, land use and land capability of planned infield roads.

Infield Roads	Soil Type	Ha	Land Use	Ha	Land Capability	Ha
	Ferrasol	9,8	CNOOC Base Airstrip	2,7	Arable	17,4
Gleysol	0,2	Natural Grassland	15,8	Wetland	1,4	
Lithosol	3,2	Village	2,8	Wilderness	3,8	
Vertisol	9,5	Wetland	1,4			



7.0 IMPACT ASSESSMENT

7.1 Impact assessment methodology

The impact assessment process compares the intensity of the impact with the sensitivity of the receiving environment. This method relies on a detailed description of both the impact and the environmental component that is the receptor. The intensity of an impact depends on its characteristics, which may include such factors as its duration, reversibility, area of extent, and nature in terms of whether positive, negative, direct, indirect or cumulative.

7.2 Description of potential impacts

Interactions between the proposed project activities and soils have been identified through a review of the project description and the identified baseline soil environment. Project activities during construction and operational phases of the project will have impacts to the baseline soil environment. The key project activity affecting the physical landscape will be ground intrusive disturbances associated with facilities within the Kingfisher Field, the oil export pipeline to Kabaale, and all associated infrastructure.

Impacts include intrusive activities directly changing the land surface and will affect chemical, physical and mechanical properties of the soil. These impacts are likely to occur within or adjacent to the project footprint.

Once the intensity of the impact and the sensitivity of the receiving environment have been described, the severity of the potential impact can be determined. The determination of significance of an impact is largely subjective and primarily based on professional judgment.

To provide a relative illustration of impact significance, it is useful to assign numerical descriptors to the impact magnitude and receptor sensitivity for each potential impact. Each is assigned a numerical descriptor of 1, 2, 3, or 4, equivalent to very low, low, medium or high. The significance of impact is then indicated by the product of the two numerical descriptors, with significance being described as negligible, minor, moderate or major, as in Table 10. This is a qualitative method designed to provide a broad ranking of the different impacts of a project. Table 11 provides illustrations of the types of impact that would be assigned to the different grades of severity.

Table 10: Determination of impact severity.

			Sensitivity of receptor			
			Very low	Low	Medium	High
			1	2	3	4
Intensity of Impact	Very low	1	1 Negligible	2 Minor	3 Minor	4 Minor
	Low	2	2 Minor	4 Minor	6 Moderate	8 Moderate
	Medium	3	3 Minor	6 Moderate	9 Moderate	12 Major
	High	4	4 Minor	8 Moderate	12 Major	16 Major





Table 11: Impact assessment criteria and rating scale.

Criteria	Rating scales
Intensity (the expected magnitude or size of the impact)	Negligible - where the impact affects the environment in such a way that natural, and /or cultural and social functions and processes are negligibly affected and valued, important, sensitive or vulnerable systems or communities are negligibly affected.
	Low - where the impact affects the environment in such a way that natural, and/or cultural and social functions and processes are minimally affected and valued, important, sensitive or vulnerable systems or communities are minimally affected. No obvious changes prevail on the natural, and / or cultural/ social functions/ process as a result of project implementation
	Medium - where the affected environment is altered but natural, and/or cultural and social functions and processes continue albeit in a modified way, and valued, important, sensitive or vulnerable systems or communities are moderately affected.
	High - where natural and/or cultural or social functions and processes are altered to the extent that they will temporarily or permanently cease, and valued, important, sensitive or vulnerable systems or communities are substantially affected. The changes to the natural and/or cultural / social- economic processes and functions are drastic and commonly irreversible.
Sensitivity of the Receptor	Low – where natural recovery of the impacted area to the baseline or pre-project condition is expected in the short-term (1-2 years), or where the potentially impacted area is already disturbed by non-project related activities occurring on a scale similar to or larger than the proposed activity.
	Medium – where natural recovery to the baseline condition is expected in the medium term (2-5 years), and where marginal disturbance or modification of the receiving environment by existing activities is present.
	High – where natural recovery of the receiving environment is expected in the long-term (>5 years) or cannot be readily predicted due to uncertainty over the nature of the potential impact, and where unique or highly valued ecological, social or cultural resources could be adversely affected.

7.2.1 Construction Phase Impacts

The following construction phase operational activities have been considered:

- Surface clearance, levelling and compaction of different construction sites;
- Trucking and hauling of building and construction material;
- Excavation, drilling and blasting to facilitate export pipeline laydown;
- Excavation and laying of foundations to host construction; and
- Linking of support infrastructure (access roads, water and power lines) to respective facilities.

During the construction phase heavy machinery (e.g., dozers, excavators, dump trucks, vibrating roller, crane and other equipment) will be used. Construction activities will result in the destruction of soils in terms of diagnostic layer sequence, chemical balances, physical properties and mechanical properties through a change in the land surface. The use of machinery during the construction phase is expected to result in spills and leakages of fuel, oil and hydraulic fluids. In addition, improper or irresponsible disposal of waste materials resulting from construction operations may lead to contamination of soils with potentially long term consequences if not mitigated. In addition, hazardous domestic waste at the accommodation facility may cause pollution of the soil. Contamination of the soil has a negative impact and mitigation measures are required to minimise or avoid this potential impact.





Excavation, transportation, stockpiling and civil stabilisation of construction sites will have an impact on soil through compaction, vibration and potentially contamination. Indirect impacts may result from the dust and contaminated seepage associated with construction activity. Soil compaction occurs when soil particles and porous network within are rearranged as a result of pressure applied on surface. Pressure will be applied by the movement of heavy vehicles and machinery during excavation procedures. The soil is expected to be more prone to compaction if stripping process takes place when the soil is in a moist state.

Soil can be lost through severe wind and water erosion caused by chemical anomalies and/or lack of surface water control measures during stripping, trucking hauling and stockpiling.

Following is a summary of activities that may result in impact during the construction phase:

- **Soil erosion:** Soil erosion triggered from existing stockpiles, and construction operations.
- **Physical, chemical and biological changes:** Change to the physical, chemical and biological properties of the soil within soil stockpiles.
- **Contamination (dust):** Contamination of topsoil and stockpiled soil due to dust fallout from construction and oil extraction plant operations.
- **Contamination (oil and fuel):** Contamination of topsoil and stockpiled soil due to oil and fuel spills.
- **Soil horizon mixing:** Mixing of different topsoil layers during stripping and stockpiling.
- **Spills:** Acid and/or alkaline spills and salinisation contaminating soil from pollution sources along preferential seepage path ways.
- **Soil loss:** Potential loss of soil at future construction. Following rehabilitation, the soils replaced at construction areas are not likely to have sufficient soil depth/properties for adequate vegetative growth, wetland establishment or suitable agricultural potential.
- **Surface disturbance (land use):** Land use converted from natural veld to oil extraction use. Following decommissioning and rehabilitation, land can be returned for natural veld use.
- **Future surface infrastructure development (land use):** Land use will be converted from natural veld to oil extraction related activities. Following closure and rehabilitation, land can be returned for natural veld.
- **Surface disturbance (land capability):** Land capability will be affected by oil extraction operations due to loss of topsoil (for surface infrastructure), soil erosion, soil contamination and changes to topography.

7.2.2 Operation Phase Impacts

Operations within any production unit will inevitably lead to contingencies such as breakages or overflows of containment structures or damaged infrastructure. Cracks in bunding or culverts will release effluents/substances through seepage that may reach underlying or adjacent soil/land, creating potential for contamination. At the camp sites and accommodation facilities illegal/irresponsible dumping may bring about contamination to the soil environment. The high clay content vertisols contain an abundance of 2:1 layer silicates that shrink and swell considerably under fluctuating moisture conditions. Careful planning and consideration should be given to the chemical, physical and mechanical properties of these soils. For example, during construction it is imperative the correct civil and engineering protocols and procedures for soils with these high plasticity index (>20) are followed and implemented to ensure the swelling, shrinking anomalies are catered for. Floating foundations, expansion joints, prevention of dam floors drying out, *etc.* should be catered for to ensure structural stability of plant and road infrastructure.

The potential exists for soil erosion on stockpiles if not maintained through vegetative cover. The erosive nature of silty clay soil and tendency to disperse after wetting will ultimately result in progressive growth of erosion gullies.





The following activities may result in impact during the operation phase:

- **Soil erosion:** Soil erosion triggered from existing stockpiles, and construction operations.
- **Physical, chemical and biological changes:** Change to the physical, chemical and biological properties of the soil within the soil stockpiles.
- **Contamination (dust):** Contamination of topsoil and stockpiled soil due to dust fallout from construction and oil extraction plant operations.
- **Contamination (oil and fuel):** Contamination of topsoil and stockpiled soil due to oil and fuel spills.
- **Soil horizon mixing:** Mixing of different topsoil layers during stripping and stockpiling.
- **Topsoil loss:** Loss of topsoil and useable soil.
- **Soil erosion:** Soil erosion triggered from recently rehabilitated areas.
- **Insufficient soil depth:** Soil depth not sufficient to allow adequate vegetation growth.
- **Spills:** Acid and/or alkaline spills and salinisation contaminating soil from pollution sources along preferential seepage path ways.
- **Soil loss:** Potential loss of soil at future construction. Following rehabilitation, the soils replaced at construction areas are not likely to have sufficient soil depth/properties for adequate vegetative growth, wetland establishment or suitable agricultural potential.
- **Surface disturbance (land use):** Land use converted from natural veld to oil extraction use. Following closure and rehabilitation, land can be returned for natural veld use.
- **Future surface infrastructure development (land use):** Land use will be converted from natural veld to oil extraction related activities. Following closure and rehabilitation, land can be returned for natural veld.
- **Surface disturbance (land capability):** Land capability will be affected by oil extraction operations due to loss of topsoil (for surface infrastructure), soil erosion, soil contamination and changes to topography.

7.2.3 Decommissioning Phase Impacts

Possible contamination of soil during decommissioning phase may emanate from sources including spillages and leakages from vehicles and machinery use, and other hazardous substances that may be used in the demolishing process. Irresponsible dumping of waste material generated during decommissioning activities may result in pollution of soil resources. There is a potential for increased traffic, particularly heavy vehicles initiating surface compaction and accidental damage to soil structures. There is the potential for uncontrolled and accidental spillages of fuel and other liquids into the ground and/or water courses during closure activity, which may cause contamination of soil.

Soil compaction may occur when soil stockpiles are removed and placed for restoration. Activities similar to those anticipated during the construction phase will apply to the decommissioning phase and may lead to compaction of the soil resource. In addition, the movement over re-established areas will also lead to soil compaction.

The following activities may result in impact during the decommissioning phase:

- **Spills:** Acid and/or alkaline spills and salinisation contaminating soil from pollution sources along preferential seepage path ways.
- **Soil loss:** Potential loss of soil at future construction. Following rehabilitation, the soils replaced at construction areas are not likely to have sufficient soil depth/properties for adequate vegetative growth, wetland establishment or suitable agricultural potential.



7.2.4 Summary of impacts to soils

A summary of the impact assessment for soils is included in Table 12.

Table 12: Summary Impact Assessment Ratings: Soils.

Phase	Location	Before mitigation			After mitigation		
		Intensity	Sensitivity	Severity	Intensity	Sensitivity	Severity
Construction	Kingfisher Camps/Parking Lots/Material Yards	High	High	High	Low	High	Moderate
	Airstrip Extension	Medium	High	High	Low	High	Moderate
	Central Processing Facility (CPF)	High	High	High	Low	High	Moderate
	Pipeline	Medium	High	High	Low	High	Moderate
	New In-Roads	High	Medium	High	Low	High	Moderate
	Crusher Plant/Spoil Area A	Low	High	Moderate	Very Low	High	Minor
	New Well Pads	Medium	High	High	Low	High	Moderate
	Jetty	Low	High	Moderate	Very Low	High	Minor
Operation	Airstrip Extension	Medium	High	High	Low	High	Moderate
	New In-Roads	Medium	Low	Moderate	Low	Low	Minor
	New Well Pads	Medium	Low	Moderate	Low	Low	Minor
	Jetty	High	High	High	Low	High	Moderate
Decommission	All infrastructure	Medium	High	High	Low	High	Moderate

7.2.5 Cumulative impacts

It is anticipated the region’s economy will continue to focus on fishing and cattle farming for the foreseeable future. The landscape could and should be returned to a state approximately the pre-development condition. The landscape topographical character can largely be restored and any pre-existing vegetation re-instated. Alternatively the area may be suitable for irrigated agriculture, which would be in keeping with the regional context.

7.2.6 Residual impacts

Residual impacts are significant project-related impacts that might remain after on-site mitigation measures (avoidance, management controls, abatement, restoration, etc.) have been implemented. The main impacts on the soils include loss of topsoil, contamination, erosion and compaction. The residual impacts of these are considered in the following section:

7.2.6.1 Soil Loss

The total footprint of the proposed footprint infrastructure will be lost for agricultural purposes. This is inevitable due to the irreparability of the soil profile and the impact cannot be mitigated. The impact is negative for the entire duration of the project.

7.2.6.2 Contamination

Soil contamination impacts are considered for the construction, operational and decommissioning phases. It is anticipated in the occurrence of spills and leaks from machinery and equipment during soil stripping and





stockpiling processes in the construction and operational phases. It is also likely to occur during restoration activity in the decommissioning phase. It is expected where containment infrastructure is damaged or overflow and hazardous fluids and substances may reach the soil, contamination poses a high potential for pollution.

7.2.6.3 Erosion

Wind and water erosion on stockpiled soil and adjacent land is identified to take place during the construction and operational phases, mainly due to lack of surface water control measures. If restoration is not conducted properly during decommissioning significant soil losses will occur.

7.2.6.4 Compaction

Topsoil will be excavated and moved with use of heavy machinery for stripping and restoration during construction and decommissioning phases, with subsequent compaction of the soil. If prevention and mitigation measures are not adhered to, the residual impact will be negative during decommissioning phases of the project.

8.0 ENVIRONMENTAL MANAGEMENT PLAN / MITIGATION AND MONITORING MEASURES

8.1 Construction Phase

Mitigation measures for the construction phase are summarised in Table 13:



SOIL IMPACT ASSESSMENT

Table 13: Mitigation Measures Soils – Construction Phase.

Mitigation Measures	Monitoring Indicators	Monitoring Frequency	Responsible Entity	Training Necessary
Erosion of soils and construction stockpiles.	Minimise soil erosion through stockpile maintenance and rehabilitate finished areas following construction. Manage the physical, chemical and biological properties of stockpiled soils. Rehabilitate finished areas following construction.	Weekly.	CNOOC Personnel and Contractors.	Yes.
Dust generated by construction and plant operations.	Minimise dust fallout from operations by wet suppression and enforcing speed limit on unpaved surfaces.	Daily.	CNOOC Personnel and Contractors.	Yes.
Construction operations (oil/fuel handling and storage).	Prevent soil contamination from spills of hazardous materials.	Daily.	CNOOC Personnel and Contractors.	Yes.
Construction of Plant and Related Infrastructure.	High clay content soils with plasticity index >20 requires specific foundation engineering requirements to ensure stable and safe construction.	Daily.	CNOOC Personnel and Contractors	Yes
Topsoil stripping during construction.	Adhere to soil stripping guidelines and have qualified supervision	Daily.	CNOOC Personnel and Contractors.	Yes.
Construction operations, rehabilitated areas.	Ensure pollution sources are isolated through clean and dirty water separation. Monitor potential increasing, static decreasing contamination anomalies. Remediate soil contamination.	Weekly.	CNOOC Personnel and Contractors.	Yes.
Future construction operations. Land clearance and soil handling, storage and replacement.	Manage the physical, chemical and biological properties of stockpiled soils. Rehabilitate closed areas following construction to achieve closure objectives.	Weekly.	CNOOC Personnel and Contractors.	Yes.
Surface disturbance to construction and establishment of oil extraction infrastructure, roads, buildings <i>etc.</i>).	Re-instate natural veld land use that is stable and safe in the long-term	Quarterly.	CNOOC Personnel and Contractors.	Yes.
Future surface infrastructure development of oil extraction infrastructure, roads, buildings <i>etc.</i>).	Re-instate natural veld that is stable and safe in the long-term	Quarterly.	CNOOC Personnel and Contractors.	Yes.
Future surface infrastructure development of oil extraction infrastructure, roads, buildings <i>etc.</i>)	Re-instate wilderness land use that is stable and safe in the long-term	Quarterly.	CNOOC Personnel and Contractors.	Yes.



SOIL IMPACT ASSESSMENT

8.2 Operations Phase

Mitigation measures for the construction phase are summarised in Table 14.

Table 14: Mitigation Measures Soils – Operations Phase.

Mitigation Measures	Monitoring Indicators	Monitoring Frequency	Responsible Entity	Training Necessary
Erosion of soils and construction stockpiles.	Minimise soil erosion through stockpile maintenance and rehabilitate finished areas following construction. Manage the physical, chemical and biological properties of stockpiled soils. Rehabilitate finished areas following construction.	Weekly.	CNOOC Personnel and Contractors.	Yes.
Dust generated by construction and plant operations.	Minimise dust fallout from operations by wet suppression and enforcing speed limit on unpaved surfaces.	Daily.	CNOOC Personnel and Contractors.	Yes.
Construction operations (oil/fuel handling and storage).	Prevent soil contamination from spills of hazardous materials.	Daily.	CNOOC Personnel and Contractors.	Yes.
Maintenance of Plant and Related Infrastructure.	High clay content soils with plasticity index >20 requires specific foundation engineering requirements to ensure stable and safe construction.	Daily.	CNOOC Personnel and Contractors	Yes
Topsoil stripping during construction.	Adhere to soil stripping guidelines and have qualified supervision.	Daily.	CNOOC Personnel and Contractors.	Yes.
Surface developments at existing operations.	Manage stockpiles and rehabilitate areas following closure in order to achieve the agreed goals for rehabilitation.	Daily.	CNOOC Personnel and Contractors.	Yes.
Rehabilitated areas.	Undertake rehabilitation measures to reduce soil erosion, improve soil depth and fertility. Conduct proper planning, undertake rehabilitation measures to reduce soil erosion, improve soil depth and fertility.	Weekly.	CNOOC Personnel and Contractors.	Yes.
Construction operations.	Ensure pollution sources are isolated through clean and dirty water separation. Monitor potential increasing, static decreasing contamination anomalies. Remediate soil contamination.	Daily.	CNOOC Personnel and Contractors.	Yes.



SOIL IMPACT ASSESSMENT

Mitigation Measures	Monitoring Indicators	Monitoring Frequency	Responsible Entity	Training Necessary
Future construction operations. Land clearance and soil handling, storage and replacement:	Manage the physical, chemical and biological properties of stockpiled soils. Rehabilitate closed areas following construction to achieve closure objectives.	Quarterly.	CNOOC Personnel and Contractors.	Yes.
Surface disturbance to construction and establishment of oil extraction infrastructure, roads, buildings <i>etc.</i>).	Re-instate natural veld land use that is stable and safe in the long-term	Quarterly.	CNOOC Personnel and Contractors.	Yes.
Future surface infrastructure development of oil extraction infrastructure, roads, buildings <i>etc.</i>)	Re-instate natural veld that is stable and safe in the long-term.	Quarterly.	CNOOC Personnel and Contractors.	Yes.



SOIL IMPACT ASSESSMENT

8.3 Decommissioning Phase

Mitigation measures for the decommissioning phase are summarised in Table 15:

Table 15: Mitigation Measures Soils – Decommission Phase.

Mitigation Measures	Monitoring Indicators	Monitoring Frequency	Responsible Entity	Training Necessary
Construction operations, rehabilitated areas.	Ensure pollution sources are isolated through clean and dirty water separation. Monitor potential increasing, static decreasing contamination anomalies according to Section 8.4.1 p45 . Remediate soil contamination.	Weekly.	CNOOC Personnel and Contractors.	Yes.
Future construction operations. Land clearance and soil handling, storage and replacement.	Manage the physical, chemical and biological properties of stockpiled soils. Rehabilitate closed areas following construction to achieve closure objectives.	Quarterly.	CNOOC Personnel and Contractors.	Yes.



8.4 Monitoring

8.4.1 Soil Monitoring

Table 16 outlines the analytical parameters recommended for soils for monitoring purposes according to standard methods and techniques according to Sparks, D. L. *ed.* (1996). Due to the intensity and amplitude of the project and sensitivity to surrounding environmental receptors it is recommended to conduct an annual monitoring frequency. This will ensure quality assurance and quality control procedures are in place and maintained for pro-active management of potential soil contamination and sediment loss. The prescribed analytical parameters will ensure measurement and quantification of the following potential anomalies:

- Acidification (low pH – increase solubility and mobility of heavy metals);
- Alkalinisation (high pH – hydrolyses of sodium);
- Sodification (excess sodium in soil solution exceeding 15% of the cation exchange capacity causing dispersion anomalies resulting in erosion);
- Salinisation (excess salts in soil solution due to spillages causing an increase in electrical conductivity values exceeding 450mS/m [saturated water extract] inducing a negative osmotic effect on normal plant growth);
- Eutrophication (excess nitrates and phosphorus in soil solution);
- Toxicity (maximum concentrations of elements for environmental receptors);
- Erosion (sediment loss due to lack of civil engineering procedures and surface water control measures in place and/or lack of maintenance and chemical contamination causing dispersion and erosion; and
- Compaction (increase in bulk density >1,750kg/m³ and consequent crust formation lowering the infiltration capacity <5 – 10mm/h).

It is recommended after finalisation of the final outlay of the proposed project infrastructure to ensure monitoring points are established for future monitoring purposes. This will ensure to calibrate increasing, static or decreasing anomalies in soil conditions as a function of the construction and operational phases.

Table 16: Analytical properties for soil monitoring.

Element	Method	Frequency
pH (H ₂ O)	Standard	Annually
CEC+Ca+Mg+K+Na	NH ₄ Ac-extraction	Annually
EC+SO ₄ +NO ₃ +B	Saturated distilled water extract	Annually
P	Bray 1-extract	Annually
Zn+Cu+Co+Cr+Fe+Se+Ni+Pb+ Cd+As+Hg+V+Mo+Sn+Ba+Al+ Be+Ti+Mn+Br+Sr+In+Sb+Te+W +Pt+Tl+Bi+U+Cn+Li	ICP Scan-saturated distilled water extract	Annually
Lime Requirement	SMP Double Buffer Titration	Annually
Compaction and Bulk Density	Standard	Annually

During the baseline assessment in January 2014 no analyses was conducted for organic compounds in soil *i.e.* diesel range organics, total petroleum hydrocarbons, volatile organic compounds, benzene, toluene, ethylbenzene, xylene, gasoline range organics and polynuclear aromatic hydrocarbons. It is recommended to conduct a screening baseline assessment during the first monitoring cycle to address fuel, oil and other related organic molecules. The complete chemical inventory of the project should be consulted to establish all chemical are catered for.





In case of accidents, spills and /or projects expansions immediate survey and sampling should be conducted to quantify the amplitude and impact of pollution.

8.4.2 Ugandan Soil Quality Monitoring Regulations

According to the 2001 Fifth Schedule National Environment Minimum Standards for Management of Soil Quality Regulations of Uganda the following frequency for soil monitoring for soil quality parameters for enforcement purposes are recommended. The recommended soil monitoring programme in Section 8.4.2 entails the requirements in the Fifth Schedule Soil Quality Standards, however at a more thorough level. This is regarded necessary to ensure all potential pollution source seepage pathway receptor continuums are covered over the area of influence during the Project lifecycle:

8.4.2.1 Soil Physical Indicators

- Bulk density and porosity – annually;
- Structure – 2 years;
- Texture – 3 years;
- Water holding capacity – 3 years;
- Infiltration – annually;
- Coarse fragments and stoniness – 5 years;
- Soil depth – 3 to 5 years; and
- Slope, depth to water table – 3 to 5 years.

8.4.2.2 Soil Biology Indicators

- Soil organic matter – annually.

8.4.2.3 Soil Chemical Indicators

- pH – annually;
- Exchangeable bases – 2 years;
- Phosphorus – 2 years;
- Cation exchange capacity – 2 years;
- Calcium carbonate – 2 years; and
- Alkalinity, sodicity – 3 to 5 years

8.5 Soil stripping utilisation guide and plan

8.5.1 Soil management

The objectives of soil management are to:

- Provide sufficient stable topsoil material for rehabilitation;
- Optimise the recovery of topsoil for rehabilitation;
- Identify soil resources and stripping guidelines;
- Identify surface areas requiring stripping;
- Manage topsoil reserves so as not to degrade the resource;
- Identify stockpile locations and dimensions; and



- Identify soil movements for rehabilitation use.

In order to provide sufficient topsoil material for rehabilitation purposes and to optimise soil recovery, the following aspects are recommended:

- Stockpiles to be located outside proposed construction disturbance area(s);
- Construction of stockpiles by dozers rather than scrapers to minimise structural degradation;
- Construction with a “rough” surface condition to reduce erosion, improve drainage and promote re-vegetation;
- Re-vegetation of stockpiles with appropriate fertiliser (based on soil analyses) and seed in order to minimise weed infestation, maintain soil organic content, soil structure and microbial activity and maximise vegetative cover of the stockpile; and
- Disturbance areas to be stripped progressively as required to reduce erosion and sediment generation, to reduce the extent of topsoil and utilise stripped topsoil as soon as possible for rehabilitation.

8.5.2 Basic volume calculations

The amount of available topsoil to be stripped prior to any development could easily be under estimated and should be treated conservatively as an infinite resource. A basic unit of 10,000m² 300mm deep can potentially yield 3,000m³ of topsoil at a bulk density ranging between 1,375 – 1,850kg/m³. An increment of 100mm depth could yield an additional 1,000m³ or could be lost due to inappropriate stripping practices.

Considering the basic volume calculations (Figure 20) it is obvious careful consideration should be given during calibration of equipment and people when stripping topsoil.

BASIC CALCULATIONS

- 1ha: 100 x 100m = 10,000m²
- Bulk Density: 1,375 – 1,850kg/m³
- Volume: 10,000m² x 0,3m = 3,000m³
 - 3,000m³ x 1,850kg/m³ = 5,550,000kg

Example:

Uncontaminated:

- 1ha/300mm: 80mg/kg SO₄ (saturated water extract) – 444kg SO₄

Contaminated:

- 1ha/300mm: 780mg/kg SO₄ (saturated water extract) – 4,329kg SO₄
- 875%

Figure 20: Basic soil volume calculations.

Soils can be formed *in situ* from underlying geology through natural weathering and/or could be transported and deposited through wet and dry geological periods. The soils will be a function of the mineralogy from which it was derived and will determine its prevailing chemical, physical and mechanical properties.

Consideration should be given to different diagnostic soil horizons of soils when stripping topsoil, *i.e.* certain layers can be stripped and mixed together and certain layers should be stockpiled separately. Careful consideration and planning should be given to different soil layers and thickness during topsoil stripping for rehabilitation purposes and should not be dictated solely by civil engineering geotechnical criteria.



Clay mineralogy (Figure 21) is the primary diagnostic criteria for soil layer identification and selection during topsoil stripping and stockpiling. The colloidal fraction (particles $<0,002\text{mm}$) can be divided in 1:1 layer and 2:1 layer silicates and should not be mixed and stockpiled together. Organic material, bulk density and seeds are secondary diagnostic criteria for horizon selection to be stripped and stockpiled.

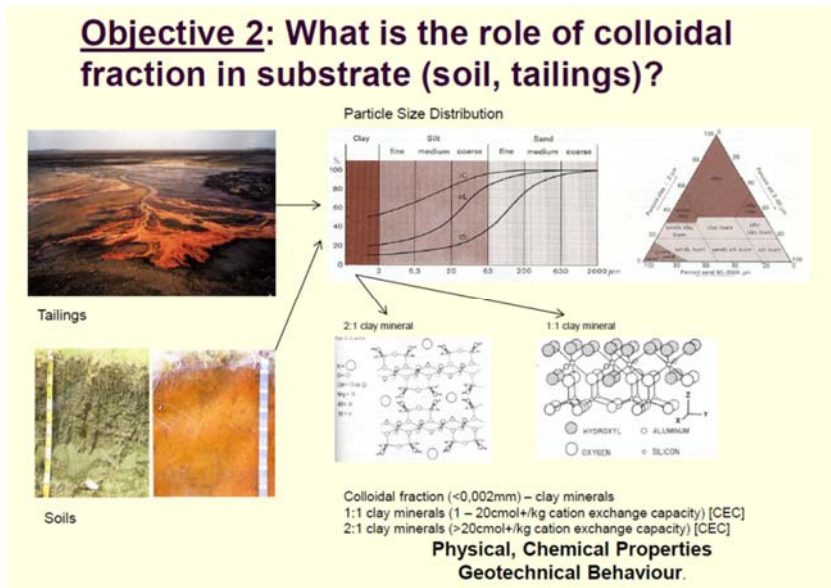

Figure 21: Influence of colloidal fraction in topsoil stripping.

8.5.3 Topsoil stripping general recommendations

8.5.3.1 Soil Layers

A review of available soil mapping information should be conducted to determine the distribution of soil types and diagnostic layers prior to any soil construction stripping project. Clear distinction should be made of available soil layers to be stripped and stockpiled separately or together. It is recommended to use an experienced soil surveyor with rehabilitation experience and track record (inclusive of failures and successes).

On completion of identifying soil layers to be stripped and stockpiled a guidance digital terrain map for earthmoving machinery should be compiled. The guidance stripping waypoints should be plotted and placed by a qualified surveyor in accordance with standard survey practices and techniques.

Covering vegetation can make the removal of specific topsoil depths difficult and excessive quantities of vegetative matter in long term stockpiles may promote chemical and biological degradation of the seed reserves that are a future source of regeneration during rehabilitation. Prior to stripping, vegetation should be removed or reduced by grazing and/or clearing in accordance with the Health and Safety Management Plan of the project.

8.5.3.2 Field practice

Prior to soil stripping activities the site engineer/supervisor must ensure the appropriate clearance approvals have been obtained. Through all stages of topsoil stripping and stockpiling, operations should be closely supervised to determine recovery depths and to identify suitable soils. The designated supervisor will direct and control the recovery, handling and management of the site soils through the following activities:

- Delineation of areas to be stripped for daily stripping operations;
- Ground truthing in the field of mapped soil types;
- Delineation of suitable stockpile areas;



- Ensuring dust generation during topsoil stripping is at acceptable levels; and
- Recording of volumes stored.

Topsoil stockpile locations, volumes and date of soil stripping should be recorded in an electronic database correlating with a digital terrain map of the area.

The means of topsoil placement within storage locations will consider the economic implications of dozer pushing relative to load and truck haul with consideration also given to access constraints, machine availability and ground conditions.

8.5.3.3 *Stripping with excavators and dump trucks*

The purpose of this section is to provide a model for best practice where excavators and dump trucks are to be used to strip soil. The specific type, size or model of equipment is not specified, however it is recommended to be contractually agreed on as part of the planning conditions of the project. The machines should be of a kind which will cause minimum compaction whilst being operated efficiently and must be well maintained.

This soil handling method uses back-acting excavators in combination with dump trucks (articulated or rigid). An excavator is used to strip soil and load it into dump trucks for transportation to storage areas. Soil handling can affect the quality of the rehabilitation through soil compaction and smearing, primarily caused through trafficking, the effects of which increases with increase in soil wetness. The advantage of this guideline, if used properly, will avoid severe deformation of the soil as trafficking is minimised and there should be no need for decompaction during the operation.

The key operational aspects to avoid soil deformation include:

- Minimise compaction;
- Dump trucks must only operate on the basal/non-soil layer and their wheels must not run on the soil layers;
- The excavator should only operate on the topsoil layer;
- Implementation of a bed/strip system avoids the need for trucks to travel on the soil layers;
- Machines are to only work when ground conditions enable their maximum operating efficiency; and
- If compaction is caused then measures are required to treat (consult an experienced specialist).

To minimise soil wetness and re-wetting the following aspects are applicable:

- The soil layers should have moisture content below their lower plastic limit. Moisture content should be addressed by for example weight loss determined by weighing wet samples, oven drying them and calculation of moisture loss taken from respective locations and mid/lower points of each horizon;
- The bed/strip provides a basis to regulate exposure of lower soil layers to periods of rain and maintaining soil moisture. The soil profile within the active strip should be stripped to be basal layer before rainfall occurs and before stripping is suspended. This is not always possible from a production perspective, however where possible should be implemented;
- Measures are required to protect the face of the soil layer from ponding of water, maintain the basal layer in condition capable of supporting dump trucks; and
- Surface water control measures must be in place to protect in-flow of water, ponding, *etc.* Wet sites should be drained in advance.

The stripping operation entails the following:

- The area to be stripped must be protected from in-flow of water, ponding (for example);





- Soil stripping operations should not start until the required soil moisture levels are reached, and should be suspended as soon as water content returns to these levels. In practice the changes of this taking place is very slim due to production targets to be met, however where possible it should be implemented. Prior to work commencing a weather forecast should be considered for potential rainfall interruptions. If significant rainfall occurs during operations, the stripping must be suspended, and where the soil profile has been disturbed it should be removed to base level. Stripping should not restart unless weather forecast is expected to be dry for a sufficient period of time;
- All machines must be in safe and efficient working condition at all times and only to work when ground conditions enable their maximum operating efficiency with skilled operators. Operation should be suspended before traction becomes a problem or the integrity of the basal layer and haul routes fail;
- Operation must follow a detailed stripping plan showing soil units to be stripped, haul routes and the phasing of vehicle movements. Soil units should be defined on site, with information to distinguish types, layers, ranges and thickness. Detailed daily records should be kept of operations undertaken with site and soil conditions;
- Within each soil unit the layers above the base/formation layer must be stripped in sequential strips with the topsoil layer stripped first, followed by the subsoil layers, each layer stripped to its natural thickness without incorporating material from the lower layers;
- The next strip is not started until the current strip is completely stripped to the basal layer;
- This is referred to as the bed strip system (Figure 22);

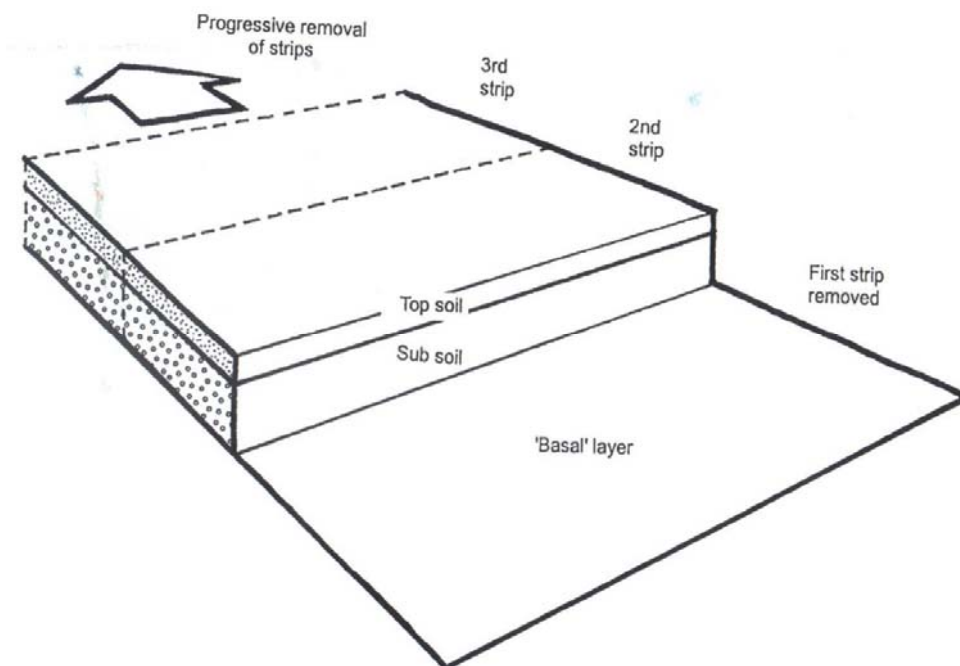

Figure 22: The bed strip system.

- If a gradient is present on site, the main axis of the soil strips should be along the axis of the slope;
- Haul roads and stockpile areas must be defined, and stripped first in a similar manner;



- The excavator is only to work on the topsoil layer and dump trucks are only to travel on the basal/formation layer;
- Stripping to be undertaken by the excavator on the surface of the topsoil and digging the topsoil to its maximum depth and loading into dump trucks (Figure 23);

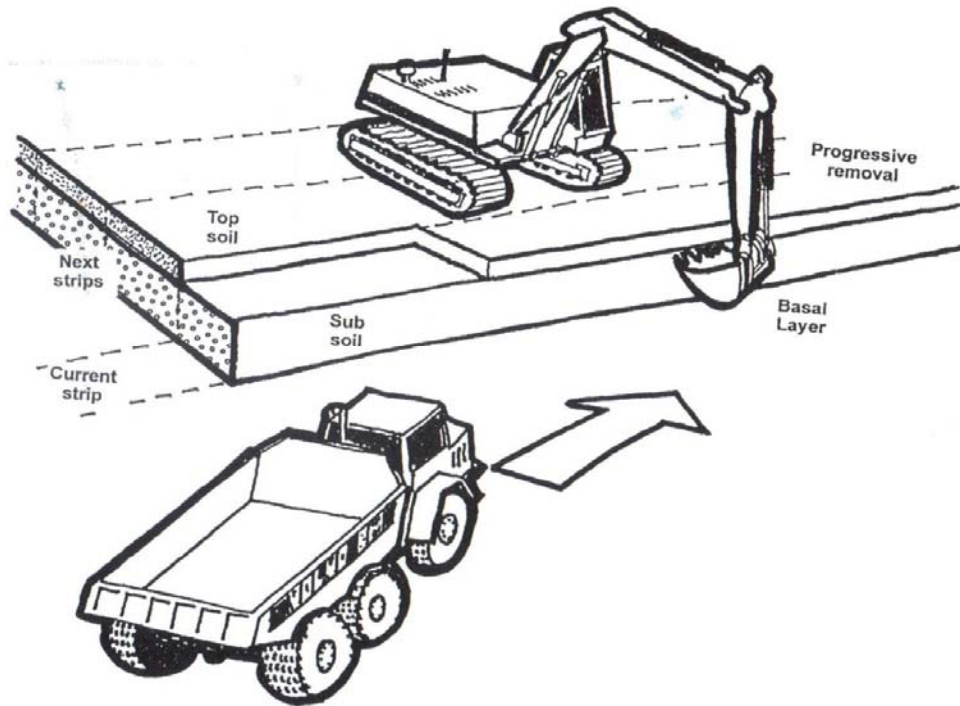

Figure 23: Removal of topsoil from a strip.

- In general a bucket with teeth is preferable;
- The dump trucks draw alongside the exposed soil profile, standing and travelling only on the basal layer;
- The initial strip width and axis should be demarcated;
- Strip width is determined by the length of the excavator boom less the stand-off to operate, typically 3 – 4m;
- Effective boom length can also reduce with profile depths greater than 1m, at 1.5m effective reach of standard boom may result in 2m wide strips;
- Topsoil should be recovered to the full width of the strip without contamination with subsoil (not more than 20% of the lower horizon should be exposed at the layer junction within the strip);
- The thickness and identification of the horizon junction must be verified before and during stripping;
- The full thickness of topsoil should be stripped progressively along the strip before subsoil horizons are started;
- The upper subsoil in the current strip must be stripped and monitored in the same manner (Figure 23);
- The final 25cm of the subsoil layer should be left as a step to protect the adjacent topsoil layer from local collapses;



- The process must be repeated for the lower subsoil and any other lower layer to be recovered as soil material;
- On completion of the strip the procedures are repeated sequentially for each subsequent strip until the area is completely stripped;
- Where soils are to be directly replaced without storage in mounds, the initial strip of the upper horizons will have to be stored temporarily to release the lowest layer and enable the sequential movement of materials;
- The stored soil would normally be placed on the lower layer removed from the final strip and the end of the programme or on partially completed profiles if rain interrupted the operation;
- Where the stripping operation is likely to be interrupted by rain or there is likely to be over-night rain, remove any exposed subsoil down to the basal layer before suspending operations;
- Make provisions to protect base of current or next strip from ponding/runoff by sumps and grips and also clean and level the basal layer; and
- At the start of each day ensure there is no ponding in the current strip or operating areas and the basal layer is to level with no ruts.

8.5.3.4 Stockpiles

Stripped soil should be stockpiled upslope of areas of disturbance or development to prevent contamination of stockpiled soils by dirty runoff or seepage (Figure 24). All stockpiles should also be protected by a bund wall or berm to prevent erosion of stockpiled material and deflect surface water runoff.

Stockpiles can be used as a barrier to screen operational activities. If stockpiles are used as screens, the same preventative measures described above should be implemented to prevent loss or contamination of soil. The stockpiles should not exceed a maximum height of 3 to 6m and it is recommended that the side slopes and surface areas be vegetated in order to prevent water and wind erosion. Consider the higher the stockpile, the longer the slopes exposed to erosion, *i.e.* 3 meter height (*if there is enough space*) is a reasonable practical optimum height. A scientific assessment should be conducted to assess what grass species occur at baseline conditions in close proximity to the stockpile area. Based on this assessment careful selection should be conducted to establish the correct species mixture in order to generate the required basal coverage and allow natural sustainable succession. The use of an annual species can be considered to function as a mother crop to stabilise the side slopes and create a micro-habitat for seed germination. If used to screen construction operations, the surface of the stockpile should not be used as a roadway as this will result in excessive soil compaction.

A general protocol for soil handling including handling measures to optimise the retention of soil characteristics (nutrients and micro-organisms) favourable to plant growth include:

- Surface of the completed stockpile must be left with rough condition to promote water infiltration and minimise erosion prior to vegetation establishment;
- Stockpiles to have a maximum height of 5m in order to limit the potential for anaerobic conditions to develop within the soil pile;
- Topsoil stockpiles to have an embankment grade of approximately **1m vertical:4m** height (to limit the potential for erosion of the outer pile face);
- Stockpiles to be seeded and fertilised; and
- Soil rejuvenation practices to be undertaken (if required) prior to re-spreading as part of the rehabilitation works.

Strategic and planned stockpiling is a necessary part of and civil engineering activities associated with an oil and gas development. The storage period for stockpiled soil ranges from a few months to several years. The



depth of the stockpile and the length of time it is stored affect the quality of the soil at replacement. Soil takes centuries to develop from parent material and organic matter. Stockpiling and the subsequent reapplication of the topsoil, allows for planting conditions that are closer to the pre-disturbance condition than planting on the subsoil layers that remain. Keeping in mind the latter is possible, however require remedial input from a specialist. If stockpiled soil is reapplied quickly, with care to reduce the compaction inherent in the use of mechanical means for stockpiling, production potential remains.



Figure 24: Stockpiling topsoil.

8.5.3.5 Earth moving equipment

Contractors are focussed on moving cubic meters of material as cost effective as possible to maximise profits and they are used to engineering properties and guidelines dictating material differentiation. They need to be guided and supervised to strip topsoil and subsequent layers and stockpile according to a rehabilitation protocol. Care must be taken not to mix different soil layers and stockpile separately as prescribed.

During topsoil stripping typical earth moving equipment (Figure 25), *i.e.* dozer, excavator, tipper, grader and front end loader will be used. Consideration should be given to the skills and experience of operators to make sure they get calibrated to the required level of operation.

For example, if it is required for the dozer operator to strip a soil layer 300mm deep he must make sure to maintain the blade at a constant depth considering the fact the machine weighs in excess of 30 tonnes, areas of subsidence might cause uneven scraping, sensitivity of controls to maintain blade stability, health, skill, experience and state of mind of the operator, *etc.*



Figure 25: Dozer, excavator, tipper, grader and front end loader earth moving equipment.

During rainstorms enough time should be allowed to wait until the site has dried of sufficiently (*no compromise*) before starting the next shift due to safety considerations and compaction. Considerable losses can occur due to compaction of heavy earthmoving machines over wet areas. Usually contractors blame a tight time schedule and budget constraints and push the agreed project time limits, however it is recommended to proactively plan and buffer for rainfall events. As an emergency measure graders and/or dozers are often used to rip soil (Figure 26) to uplift compaction prior to stripping.



Figure 26: Grader ripping compacted soil.

8.5.3.6 Contamination

Alkaline and/or acidic anomalies could occur from processed and stockpiled waste rock exposed to surface conditions ideal for oxidation and reduction chemical reactions. Figure 27 illustrates the effect of amphibole mineralogy resulting in alkaline conditions and pyrite resulting in acid conditions.

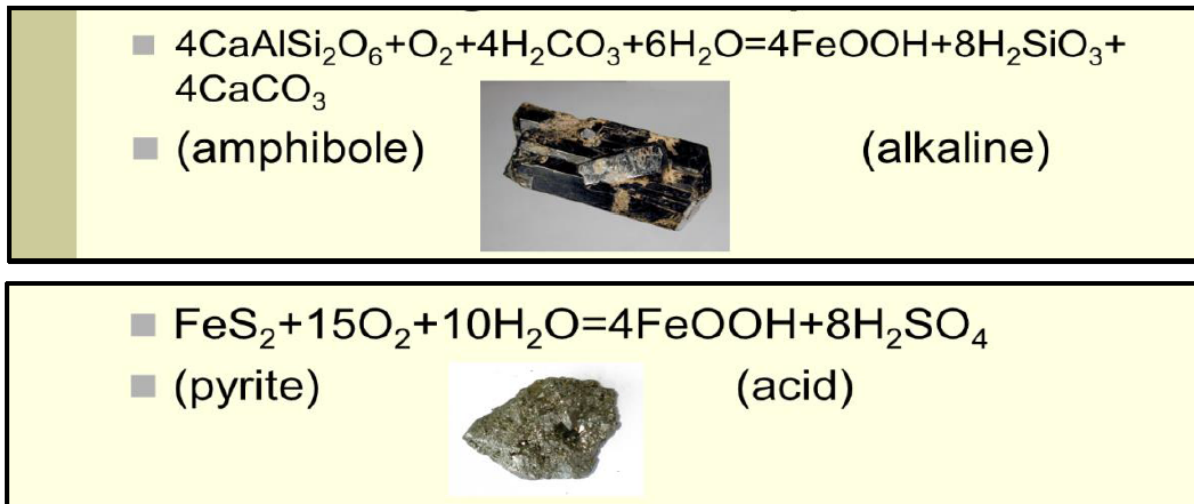

Figure 27: Influence of geology on soil contamination.

From a **pollution source seepage pathway receptor** continuum in unsaturated and saturated soil water conditions precautions should be taken not to contaminate stripped and stockpiled topsoil.

Soil contamination in the form of *acidification, alkalisation, erosion, salinisation and heavy metal contamination* and *loss of topsoil* due to dispersion of clay particles should be prevented. General maintenance and safety precautions should be followed in accordance with a daily *Hazard Identification Risk Assessment* to prevent diesel and hydraulic fluids contaminating soil. If an incident occurs it should be reported and addressed.

Topsoil stripping and stockpiling for rehabilitation purposes requires a specific operational procedure that differs from conventional engineering ground moving protocols. Consideration should be given to available machinery, past experience and track record of potential contractors to be appointed for topsoil stripping and stockpiling projects. Quality assurance quality control executed by a qualified and dedicated individual is necessary for successful monitoring of operational activities during topsoil stripping. A daily quantified audit and database kept on a digital terrain map of the area to be stripped will keep a calibrated line available to track progress and success. Furthermore will it enable proactive management to prevent failures.

General maintenance and safety precautions should be followed in accordance with a daily *Hazard Identification Risk Assessment* to prevent diesel and hydraulic fluids contaminating soil. If an incident occurs it should be reported and addressed and in most cases the contaminated area can be diluted into clean soil or if very significant the spilled area should be removed and treated.

Surface water control measures should be in place during topsoil stripping operations to prevent topsoil losses due to water erosion. Construction sites are always earmarked by preferential seepage and drainage pathways eroding vast quantities of sediment away, mainly due to bad housekeeping and lack of supervision.

Strategic and planned stockpiling is a necessary part of this proposed development. The storage period for stockpiled soil ranges from a few months to several years. The depth of the stockpile and the length of time it is stored affect the quality of the soil at replacement. Soil takes centuries to develop from parent material and organic matter. Stockpiling and the subsequent reapplication of the topsoil, allows for planting conditions that are closer to the pre-disturbance condition than planting on the subsoil layers that remain. If stockpiled soil is reapplied quickly, with care to reduce the compaction inherent in the use of mechanical means for stockpiling, production potential remains.

A conservative estimate of anticipated available topsoil to be stripped is summarised in Table 17 and Table 18.



Table 17: Kingfisher Development Area available topsoil

Soil Type & Average Effective Depth (mm)	Size (ha)	Available Volume (m ³)
Ferrasol (600)	311	948,000
Gleysol (300)	58	174,000
Vertisol (300)	212	636,000
TOTAL		1,758,000m³ @ BD*: 1,275kg/m³

*Note: BD = Bulk density

At the Kingfisher Development Area an estimated total 527ha could potentially be covered 300mm thick at a bulk density of 1,275kgm³ during rehabilitation taking into consideration a 10% loss of topsoil due to handling, compaction etc.

Table 18: Pipeline route available topsoil

Soil Type & Average Effective Depth (mm)	Size (ha)	Available Volume (m ³)
Ferrasol (600)	1,923	11,538,000
TOTAL		11,538,000m³ @ BD*: 1,275kg/m³

*Note: BD = Bulk density

Along the Pipeline route an estimated total 3,461ha could potentially be covered 300mm thick at a bulk density of 1,275kgm³ during rehabilitation taking into consideration a 10% loss of topsoil due to handling, compaction etc.

9.0 CONCLUSIONS

- The dominant soil forms recorded and identified according to the FAO Soil classification system on the Kingfisher Development Area are Ferrasols, Gleysols, Lithosols and Vertisols. On the Pipeline route Ferrasols and Lithosols were identified.
- The effective depth of the Ferrasols exceeds 300mm inclusive of the A and Oxidic B - Horizons. The effective depth of the Lithosols, Vertisols and Gleysols is <300mm limited to Hard Rock, Vertic, and Histic H – Horizons.
- The Kingfisher Development Area occurs on the shores of Lake Albert with soils weathered from dolerite geology with high clay content soils. Preferential seepage and natural drainage lines over time created wetland areas with characteristically gley mottling high clay content soils.
- The Pipeline route occurs on the escarpment, which is predominantly granite silica rich geology that weathered to light textured soils. There is a possibility the deeper, sandy soils are wind transported deposits.
- The A - Horizon is rich in organic matter and micro-organism activity representing a delicate micro-habitat. The Oxidic B – Horizon is characterised by well aerated and drained sandy soil profiles with an average clay content of 10-15% represented by predominantly 1:1 clay minerals. The Vertic and Histic H – Horizons are characterised by high clay content low aerated low permeability soil profiles with clay content >20% of mainly 2:1 clay minerals.
- The agricultural potential of the Ferrasols soils is considered medium to high under dryland (700 – 1,400mm/y rainfall) and irrigation conditions (>10-15mm/week 33-1,500kPa plant available water).
- Evidence of severe soil erosion was observed during the investigation.





- The current land use on the Kingfisher Development Area includes 3,16% basecamp & airstrip infrastructure, 61,6% natural grassland, 0,7% cultivated land, 15,7% village and immediate surrounds and 18,82% wetland. The Pipeline route includes 17% natural grassland and 83% cultivated land.
- The current land capability of the Kingfisher Development Area includes 56% arable, 19% wetland and 25% wilderness. The pipeline route includes 83% arable and 17% grazing.
- A soil stripping and stockpiling strategy has been compiled. During construction careful planning should be conducted with regards to stripping, handling and placement of topsoil. On the Kingfisher Development Area an estimated total 527ha could potentially be covered 300mm thick at a bulk density of 1,275kgm³ during rehabilitation taking into consideration a 10% loss of topsoil from the 1,758,000m³ due to handling, compaction *etc.* On the Pipeline route an estimated total 3,461ha could potentially be covered 300mm thick (bulk density 1,275kgm³) considering a 10% loss of topsoil from the 11,583,000m³.
- The soils are characterised by neutral pH values (5,3 and 7,2) and low electrical conductivity values (<250mS/m). Under these conditions plant available nitrogen (15-20mg/kg), phosphorus (10-15mg/kg) and potassium (>50mg/kg) are readily available for plant uptake and sustainable plant growth. The A - Horizon is typically characterised by a low dense structure and texture distribution of approximately 65% sand, 20% silt and 15% clay with drainage properties in order of 10mm/h. The dominant clay mineral in the A and Oxic B – Horizon is kaolinite (1:1 layer silicate), with a low buffer capacity due to the low cation exchange capacity (<10cmol+/kg). The Vertic and Histic H – Horizons contain predominantly smectite (2:1 layer silicate) with high buffer capacity due to high cation exchange capacity (>10cmol+/kg).
- The soil horizons of the Ferrasols, Vertisols and Gleysols are suitable for rehabilitation purposes.

10.0 REFERENCES

- International Finance Corporation World Bank Group, 2006. Performance Standard 3: Pollution Prevention and Abatement.
- International Finance Corporation; Environmental, Health, and Safety (EHS) Guidelines; GENERAL EHS GUIDELINES.
- Sparks, D. L. ed. 1996. Methods of Soil Analyses. Soil Science Society Of America, Inc. American Society of Agronomy, Inc. Madison, Wisconsin, USA
- 2001 Fifth Schedule National Environment Minimum Standards for Management of Soil Quality Regulations of Uganda





GOLDER ASSOCIATES AFRICA (PTY) LTD.

Author: Chris Viljeon
Soil specialist
M.Sc Soil Science, Uni. of Potchefstroom

Senior review: Brent Baxter
Senior EIA Consultant
Ph.D. (Botany), B.Sc Hons, B.Sc. Uni. Natal
Prof. Natural Scientist, Registered ESIA
Professional



APPENDIX A

Kingfisher Development Area soil observation points and GPS data



SOIL IMPACT ASSESSMENT

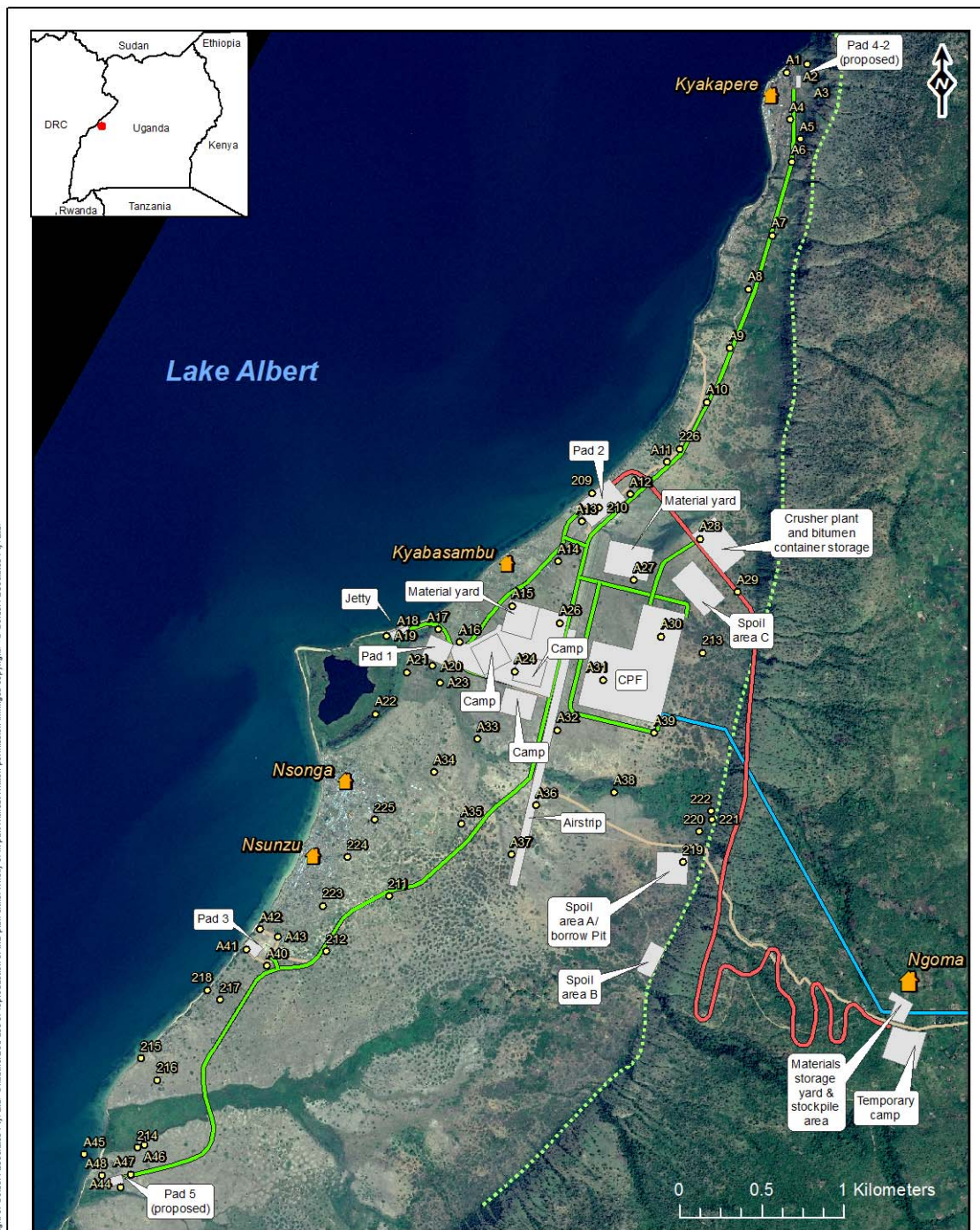

Information contained on this drawing is the copyright of Golder Associates Pty. Ltd. Unauthorised use or reproduction of this plan either wholly or in part without written permission infringes copyright. © Golder Associates Pty. Ltd.

LEGEND	RESOURCES/NOTES
○ Soil sample points	— Pipeline to Kabaale (new)
🏠 Villages	▭ Infrastructure/ facilities
— Escarpment road	
— New in-roads	
— Existing roads	

PROJECT			
13615730 CNOOC			
TITLE			
SOIL SAMPLE LOCATIONS			
 Golder Associates Durban, South Africa	GIS CAA 13/05/2014 CHECK AB 13/05/2014 REVIEW NS 13/05/2014	PROJECT No. 13615730 SCALE 1:30 500 A4	REV 0

K:\GIS\GIS Projects\13615730_CNOOC\XDS\Soil sample points 2014.mxd





SOIL IMPACT ASSESSMENT

ID	LAT	LONG	ID	LAT	LONG
209	1.25547003	30.74958301	A23	1.24501856	30.74126983
210	1.25465297	30.74995500	A24	1.24565164	30.74538216
211	1.23329001	30.73849098	A26	1.24832010	30.74780445
212	1.23025400	30.73506102	A27	1.25068841	30.75187135
213	1.24669603	30.75560297	A28	1.25294784	30.75547624
214	1.21947303	30.72476997	A29	1.25004401	30.75749896
215	1.22437502	30.72495697	A3	1.27814652	30.76173727
216	1.22318202	30.72584596	A30	1.24757319	30.75332393
217	1.22758696	30.72927801	A31	1.24518192	30.75018784
218	1.22812701	30.72857997	A32	1.24243400	30.74770404
219	1.23516596	30.75455398	A33	1.24194592	30.74331393
220	1.23686397	30.75544397	A34	1.24011296	30.74095434
221	1.23753502	30.75611603	A35	1.23727108	30.74242930
222	1.23797097	30.75608401	A36	1.23830943	30.74651297
223	1.23275198	30.73489397	A37	1.23559998	30.74516541
224	1.23543896	30.73621102	A38	1.23900655	30.75079528
225	1.23749898	30.73769797	A39	1.24228698	30.75299603
226	1.25789802	30.75435700	A4	1.27601014	30.76039323
A1	1.27857995	30.76020288	A40	1.22946786	30.73183969
A10	1.26045919	30.75581856	A41	1.23036196	30.73071601
A11	1.25716117	30.75365435	A42	1.23147600	30.73146301
A12	1.25540901	30.75168896	A43	1.23105196	30.73241100
A13	1.25388896	30.74902100	A44	1.21728502	30.72384470
A14	1.25169667	30.74772021	A45	1.21909341	30.72184595
A15	1.24925234	30.74523565	A46	1.21962600	30.72513903
A16	1.24725971	30.74235697	A47	1.21799203	30.72440100
A17	1.24794803	30.74117403	A48	1.21792104	30.72284398
A18	1.24775600	30.73958599	A5	1.27491622	30.76092305
A19	1.24757998	30.73836701	A6	1.27364804	30.76046297
A2	1.27902519	30.76131222	A7	1.26962271	30.75942043
A20	1.24594098	30.74087396	A8	1.26667496	30.75810631
A21	1.24560202	30.73947401	A9	1.26343678	30.75709319
A22	1.24330278	30.73773871			





APPENDIX B

Pipeline Route Study Area soil observation points and GPS data



SOIL IMPACT ASSESSMENT

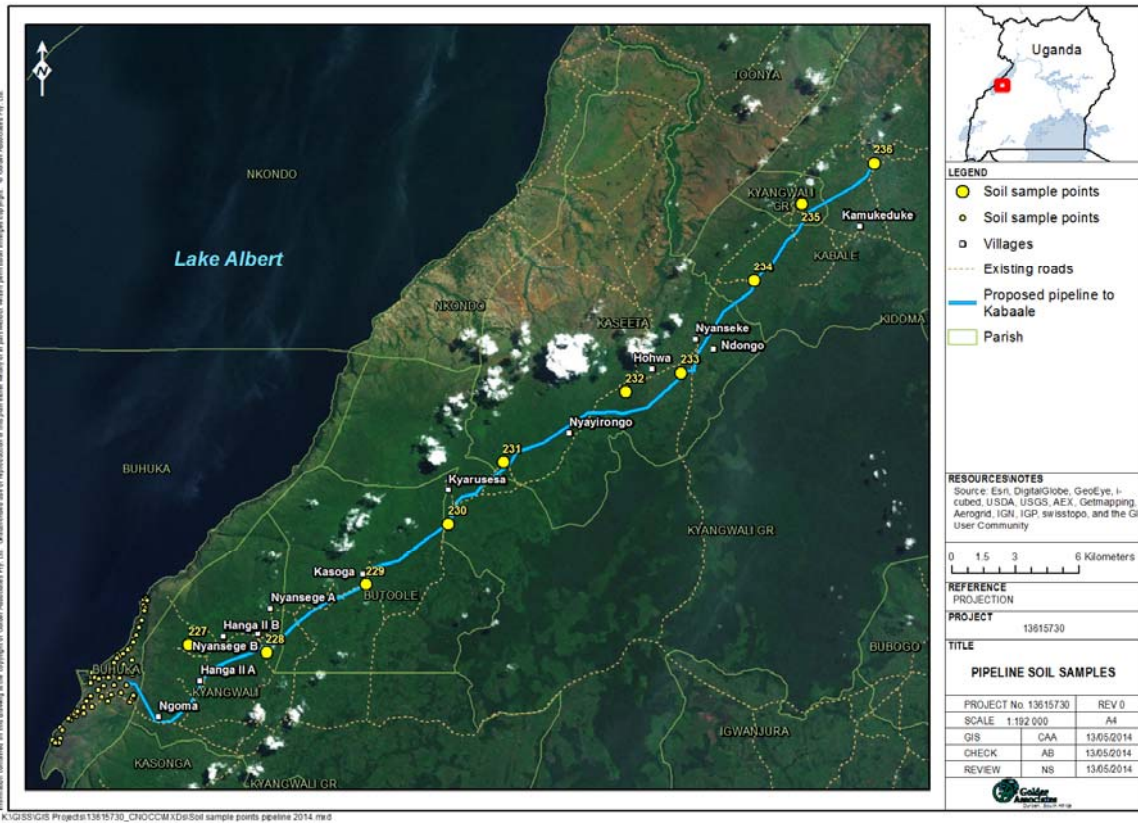

ID	LAT	LONG
227	1.25927098	30.77940599
228	1.25607898	30.81216598
229	1.28500401	30.85424699
230	1.31105496	30.88901898
231	1.33729996	30.91228002
232	1.36738898	30.96422402
233	1.37549101	30.98746100
234	1.41481697	31.01848703
235	1.44788702	31.03852096
236	1.46514703	31.06911901





APPENDIX C

Summary of all soil observation points and samples



SOIL IMPACT ASSESSMENT

Soil observation number	Depth sampled (mm)	Laboratory number
A1	300	1
A1	600	2
A1	900	3
A2	300	4
A3	300	5
A4	300	6
A5	300	7
A6	300	8
A7	300	9
A8	300	10
A9	300	11
A9	600	12
A9	900	13
A10	300	14
A11	300	15
A12	300	16
A13	300	17
A13	600	18
A14	300	19
A15	300	20
A16	300	21
A17	300	22
A18	300	23
A19		no sample taken
A20	300	24
A21	300	25
A21	300	26
A22	300	27
A22	600	28
A23	300	29
A23	600	30
A24	300	31
A25		no sample taken
A26	300	32
A27	300	33
A27	600	34
A27	900	35
A28	300	36
A29	300	37
A30	300	38



SOIL IMPACT ASSESSMENT

Soil observation number	Depth sampled (mm)	Laboratory number
A31	300	39
A31	600	40
A32	300	41
A33	300	42
A34	300	43
A35	300	44
A36	300	45
A36	600	46
A36	900	47
A37	300	48
A38	300	49
A39	300	50
209	300	51
209	600	52
209	900	53
210	300	54
211	300	55
212	300	56
A40	300	57
A41	300	58
A41	600	59
A41	900	60
A42	300	61
A43	300	62
213	300	63
213	600	64
213	900	65
A44		no sample taken
A45	300	66
214	300	67
A46	300	68
A46	600	69
A47	300	70
A48	300	71
215	300	72
216	300	73
216	600	74
216	900	75
217	300	76
223	300	77





SOIL IMPACT ASSESSMENT

Soil observation number	Depth sampled (mm)	Laboratory number
224	300	78
225	300	79
226		no sample taken
7	300	80
227	300	81
228	300	82
229	300	83
229	600	84
229	900	85
230	300	86
231	300	87
231	600	88
232	300	89
233	300	90
234	300	91
234	600	92
234	900	93
235	300	94
236	300	95



APPENDIX D

Chemical analysis results



INSTITUTE FOR SOIL, CLIMATE AND WATER
INSTITUUT VIR GROND, KLIMAAT EN WATER

RESULTS FOR REPORT No: GROND 201314 5155
RESULTATE VIR VERSLAG Nr:

Client : Mr. C.J. Viljoen

Tel : 018 297 7455

Klient :

Viljoen & Associates

Fax / Faks : 018 290 7500

P.O. Box 20954

Date / Datum : 08/04/2014

POTCHEFSTROOM

2520

CHEMICAL ANALYSIS / CHEMIESE ONTLEDINGS

LabNo	Sender ID	C	Tit. Acid	Al	Resistance	pH	pH	P
		%	cmol(+)/kg	cmol(+)/kg	ohm	H2O	KCL	Brayl
M 2831	1							
M 2832	2							
M 2833	3							
M 2834	4							
M 2835	5							
M 2836	6							
M 2837	7							
M 2838	8							
M 2839	9							
M 2840	10							
M 2841	11							
M 2842	12							
M 2843	13							
M 2844	14							
M 2845	15							
M 2846	16							
M 2847	17							
M 2848	18							
M 2849	19							
M 2850	20							
M 2851	21							
M 2852	22							
M 2853	23							
M 2854	24							
M 2855	25							
M 2856	26							
M 2857	27							
M 2858	28							
M 2859	29							
M 2860	30							
M 2861	31							
M 2862	32							
M 2863	33							
M 2864	34							
M 2865	35							
M 2866	36							
M 2867	37							



INSTITUTE FOR SOIL, CLIMATE AND WATER
INSTITUUT VIR GROND, KLIMAAT EN WATER

RESULTS FOR REPORT No: GROND 201314 5155
RESULTATE VIR VERSLAG Nr:

Client : Mr. C.J. Viljoen

Tel : 018 297 7455

Klient :

Viljoen & Associates

Fax / Faks : 018 290 7500

P.O. Box 20954

Date / Datum : 08/04/2014

POTCHEFSTROOM

2520

CHEMICAL ANALYSIS / CHEMIESE ONTLEDINGS

LabNo	Sender ID	C	Tit. Acid	Al	Resistance	pH	pH	P
		%	cmol(+)/kg	cmol(+)/kg	ohm	H2O	KCL	Brayl
M 2868	38							
M 2869	39							
M 2870	40							
M 2871	41							
M 2872	42							
M 2873	43							
M 2874	44							
M 2875	45							
M 2876	46							
M 2877	47							
M 2878	48							
M 2879	49							
M 2880	50							
M 2881	51							
M 2882	52							
M 2883	53							
M 2884	54							
M 2885	55							
M 2886	56							
M 2887	57							
M 2888	58							
M 2889	59							
M 2890	60							
M 2891	61							
M 2892	62							
M 2893	63							
M 2894	64							
M 2895	65							
M 2896	66							
M 2897	67							
M 2898	68							
M 2899	69							
M 2900	70							
M 2901	71							
M 2902	72							
M 2903	73							
M 2904	74							



INSTITUTE FOR SOIL, CLIMATE AND WATER
INSTITUUT VIR GROND, KLIMAAT EN WATER

RESULTS FOR REPORT No: GROND 201314 5155
RESULTATE VIR VERSLAG Nr:

Client : Mr. C.J. Viljoen

Tel : 018 297 7455

Klient :

Viljoen & Associates

Fax / Faks : 018 290 7500

P.O. Box 20954

Date / Datum : 08/04/2014

POTCHEFSTROOM

2520

CHEMICAL ANALYSIS / CHEMIESE ONTLEDINGS

LabNo	Sender ID	C	Titr. Acid	Al	Resistance	pH	pH	P
		%	cmol(+)/kg	cmol(+)/kg	ohm	H2O	KCL	Brayl
M 2905	75							
M 2906	76							
M 2907	77							
M 2908	78							
M 2909	79							
M 2910	80							
M 2911	81							
M 2912	82							
M 2913	83							
M 2914	84							
M 2915	85							
M 2916	86							
M 2917	87							
M 2918	88							
M 2919	89							
M 2920	90							
M 2921	91							
M 2922	92							
M 2923	93							
M 2924	94							
M 2925	95							

EXCHANGEABLE / EXTRACTABLE CATIONS cmol(+)/kg Amm. Acetate Method

LabNo	Sender ID	Na	K	Ca	Mg	S-Value	CEC
M 2831	1	0.404	0.695	8.101	1.063	10.263	7.759
M 2832	2	0.653	1.306	10.339	3.132	15.430	18.194
M 2833	3	0.479	0.997	8.519	2.443	12.438	12.669
M 2834	4	0.083	0.706	29.188	5.873	35.851	46.569
M 2835	5	0.103	0.704	24.777	3.349	28.932	36.586
M 2836	6	0.370	1.763	20.060	4.319	26.512	26.011
M 2837	7	0.131	0.600	19.579	2.104	22.415	26.398
M 2838	8	0.087	0.925	16.187	2.464	19.663	22.559
M 2839	9	0.085	0.633	18.044	3.524	22.286	25.595
M 2840	10	0.097	0.441	11.351	4.835	16.724	21.717
M 2841	11	1.350	0.508	8.861	9.803	20.522	31.685
M 2842	12	3.212	0.503	19.299	14.613	37.627	35.341
M 2843	13	4.526	0.459	29.487	14.565	49.037	32.875



APPENDIX E

Particle size analysis results



INSTITUTE FOR SOIL, CLIMATE AND WATER
INSTITUUT VIR GROND, KLIMAAT EN WATER

RESULTS FOR REPORT No: GROND 201314 5155
RESULTATE VIR VERSLAG Nr:

Client : Mr. C.J. Viljoen

Tel : 018 297 7455

Klient :

Viljoen & Associates

Fax / Faks : 018 290 7500

P.O. Box 20954

Date / Datum : 08/04/2014

POTCHEFSTROOM

2520

PARTICLE SIZE DISTRIBUTION - 3 FRACTION / DEELTJIEGROOTTE VERSPREIDING

LabNo	Sender ID	SAND	SILT	CLAY
		%	%	%
M 2831	1	94.0	0.0	6.0
M 2837	7	68.0	16.0	16.0
M 2844	14	54.0	18.0	28.0
M 2850	20	36.0	8.0	56.0
M 2855	25	26.0	24.0	50.0
M 2862	32	42.0	10.0	48.0
M 2869	39	44.0	10.0	46.0
M 2875	45	34.0	12.0	54.0
M 2884	54	22.0	12.0	66.0
M 2891	61	46.0	12.0	42.0
M 2898	68	60.0	8.0	32.0
M 2906	76	50.0	8.0	42.0
M 2910	80	82.0	6.0	12.0
M 2913	83	38.0	14.0	48.0
M 2919	89	52.0	14.0	34.0
M 2924	94	48.0	12.0	40.0



APPENDIX F

Exchangeable/extractable cation (CEC) analysis results



INSTITUTE FOR SOIL, CLIMATE AND WATER
INSTITUUT VIR GROND, KLIMAAT EN WATER

RESULTS FOR REPORT No: GROND 201314 5155
RESULTATE VIR VERSLAG Nr:

Client : Mr. C.J. Viljoen

Tel : 018 297 7455

Klient :

Viljoen & Associates

Fax / Faks : 018 290 7500

P.O. Box 20954

Date / Datum : 08/04/2014

POTCHEFSTROOM

2520

EXCHANGEABLE / EXTRACTABLE CATIONS cmol(+)/kg Amm. Acetate Method							
LabNo	Sender ID	Na	K	Ca	Mg	S-Value	CEC
M 2844	14	0.342	3.639	10.670	5.733	20.384	27.286
M 2845	15	1.117	0.888	9.632	8.960	20.597	31.165
M 2846	16	2.223	0.685	16.231	14.133	33.272	46.177
M 2847	17	0.885	0.986	23.984	12.052	37.906	49.219
M 2848	18	5.172	0.815	16.377	15.520	37.884	55.839
M 2849	19	2.791	0.593	11.389	14.550	29.323	43.195
M 2850	20	3.246	1.407	14.728	14.407	33.788	46.565
M 2851	21	2.029	1.490	13.878	9.027	26.423	40.094
M 2852	22	10.881	1.340	16.070	14.657	42.948	45.327
M 2853	23	0.559	0.249	6.069	0.841	7.717	3.068
M 2854	24	1.716	1.164	19.655	10.257	32.792	57.043
M 2855	25	2.955	1.255	21.978	13.252	39.441	59.094
M 2856	26	7.885	0.534	21.868	13.424	43.712	60.475
M 2857	27	4.572	0.701	9.067	5.886	20.226	28.520
M 2858	28	8.693	0.719	12.375	8.042	29.829	36.188
M 2859	29	1.184	0.989	21.916	11.416	35.505	54.596
M 2860	30	1.427	0.389	20.577	10.522	32.915	47.233
M 2861	31	2.132	1.169	15.683	9.946	28.930	45.165
M 2862	32	2.347	0.653	13.616	7.727	24.343	33.914
M 2863	33	1.975	1.462	16.549	13.476	33.463	50.841
M 2864	34	5.264	0.692	15.290	14.609	35.854	52.567
M 2865	35	7.388	0.775	20.619	14.714	43.496	55.367
M 2866	36	2.229	0.413	8.913	10.459	22.014	34.825
M 2867	37	0.150	0.453	9.338	4.867	14.807	21.842
M 2868	38	0.812	0.493	14.363	6.969	22.638	33.882
M 2869	39	2.546	0.930	11.506	11.234	26.216	36.152
M 2870	40	3.967	0.773	27.971	14.109	46.820	31.182
M 2871	41	2.333	0.609	13.077	11.787	27.806	38.050
M 2872	42	3.217	0.477	12.198	13.826	29.718	36.165
M 2873	43	0.783	0.764	11.039	6.191	18.776	27.543
M 2874	44	2.328	0.441	6.283	5.230	14.282	20.106
M 2875	45	4.799	0.740	11.967	14.630	32.136	40.437
M 2876	46	6.041	0.719	12.691	15.542	34.992	41.029
M 2877	47	6.528	0.809	22.433	15.446	45.216	44.810
M 2878	48	5.035	0.804	9.882	15.508	31.229	32.113
M 2879	49	3.303	0.607	18.095	10.800	32.805	36.298
M 2880	50	4.416	0.644	5.441	10.529	21.030	23.580
M 2881	51	1.014	0.988	15.385	6.740	24.126	52.403



INSTITUTE FOR SOIL, CLIMATE AND WATER
INSTITUUT VIR GROND, KLIMAAT EN WATER

RESULTS FOR REPORT No: GROND 201314 5155
RESULTATE VIR VERSLAG Nr:

Client : Mr. C.J. Viljoen

Tel : 018 297 7455

Klient :

Viljoen & Associates

Fax / Faks : 018 290 7500

P.O. Box 20954

Date / Datum : 08/04/2014

POTCHEFSTROOM

2520

EXCHANGEABLE / EXTRACTABLE CATIONS cmol(+)/kg Amm. Acetate Method							
LabNo	Sender ID	Na	K	Ca	Mg	S-Value	CEC
M 2882	52	2.001	0.759	24.048	15.028	41.836	52.375
M 2883	53	4.441	0.979	58.372	15.269	79.062	57.210
M 2884	54	5.071	1.109	82.838	15.751	104.769	54.102
M 2885	55	3.218	0.970	22.002	15.377	41.567	22.405
M 2886	56	0.316	1.379	5.265	5.605	12.565	25.289
M 2887	57	0.490	2.879	11.173	4.206	18.748	26.242
M 2888	58	2.630	2.444	25.771	6.465	37.310	27.654
M 2889	59	3.368	1.603	14.890	5.848	25.708	28.583
M 2890	60	10.053	3.053	61.512	13.181	87.798	33.362
M 2891	61	2.856	2.429	18.814	7.175	31.274	33.192
M 2892	62	0.517	1.364	15.177	5.512	22.569	28.566
M 2893	63	0.189	0.919	11.929	4.895	17.931	23.940
M 2894	64	0.341	0.773	22.760	6.596	30.470	27.627
M 2895	65	0.687	0.517	17.053	4.245	22.502	20.828
M 2896	66	0.527	0.228	12.604	1.334	14.693	5.016
M 2897	67	142.208	0.987	57.936	15.425	216.555	17.807
M 2898	68	4.536	0.587	11.332	7.620	24.074	23.551
M 2899	69	11.328	0.397	24.042	11.041	46.808	32.307
M 2900	70	5.475	0.623	24.830	9.212	40.140	32.604
M 2901	71	0.970	1.658	33.751	6.840	43.219	35.878
M 2902	72	0.177	0.099	1.232	0.841	2.349	2.742
M 2903	73	5.342	2.476	22.060	6.845	36.723	31.535
M 2904	74	8.591	1.552	64.126	6.950	81.219	35.152
M 2905	75	11.703	1.530	29.227	8.228	50.688	35.544
M 2906	76	1.320	1.670	13.790	7.548	24.328	31.215
M 2907	77	0.431	1.587	8.749	5.116	15.883	22.361
M 2908	78	1.418	1.040	11.914	6.014	20.386	25.418
M 2909	79	1.245	0.969	9.068	6.023	17.306	26.127
M 2910	80	0.109	0.134	13.459	7.894	21.595	9.729
M 2911	81	0.043	0.408	7.500	3.458	11.410	18.114
M 2912	82	0.049	0.405	7.462	2.671	10.587	18.071
M 2913	83	0.044	0.198	12.175	3.104	15.521	22.164
M 2914	84	0.055	0.093	5.982	1.745	7.875	9.432
M 2915	85	0.060	0.074	3.884	1.761	5.779	10.048
M 2916	86	0.092	0.110	1.948	0.805	2.955	4.014
M 2917	87	0.099	0.107	1.868	0.699	2.774	11.028
M 2918	88	0.062	0.076	0.702	0.218	1.059	8.593
M 2919	89	0.462	1.027	12.007	5.436	18.932	23.982



INSTITUTE FOR SOIL, CLIMATE AND WATER
INSTITUUT VIR GROND, KLIMAAT EN WATER

RESULTS FOR REPORT No: GROND 201314 5155
RESULTATE VIR VERSLAG Nr:

Client : Mr. C.J. Viljoen

Tel : 018 297 7455

Klient :

Viljoen & Associates

Fax / Faks : 018 290 7500

P.O. Box 20954

Date / Datum : 08/04/2014

POTCHEFSTROOM

2520

EXCHANGEABLE / EXTRACTABLE CATIONS cmol(+)/kg Amm. Acetate Method							
LabNo	Sender ID	Na	K	Ca	Mg	S-Value	CEC
M 2920	90	0.081	0.435	11.201	3.605	15.322	18.495
M 2921	91	0.076	0.679	11.207	4.230	16.192	25.700
M 2922	92	0.096	0.222	6.384	5.667	12.369	14.756
M 2923	93	0.087	0.198	5.227	4.361	9.873	11.984
M 2924	94	0.046	0.539	5.105	1.698	7.389	8.220
M 2925	95	0.066	0.180	1.289	0.703	2.238	1.991



APPENDIX G

Heavy metal analysis results

mg/kg	Sender ID	7Li	9Be	11B	47Ti	51V	52Cr	55Mn	59Co	60Ni	65Cu	66Zn	75As	79Br	82Se	85Rb	88Sr	95Mo	111Cd	118Sn	121Sb	125Te	127I	133Cs	137Ba	139La	182W	195Pt	202Hg	205Tl	208Pb	209Bi	238U	
		mg/kg	mg/kg	mg/kg	mg/kg	mg/kg	mg/kg	mg/kg	mg/kg	mg/kg	mg/kg	mg/kg	mg/kg	mg/kg	mg/kg	mg/kg	mg/kg	mg/kg	mg/kg	mg/kg	mg/kg	mg/kg	mg/kg	mg/kg	mg/kg	mg/kg	mg/kg	mg/kg	mg/kg	mg/kg	mg/kg	mg/kg	mg/kg	mg/kg
M2425	1	0.142	0.005	0.035	15.48	0.208	0.381	0.239	0.027	0.135	0.116	0.138	0.012	0.096	0.012	0.098	0.138	0.008	0.001	0.006	0.002	0.001	0.033	0.059	<0.001	0.103	0.007	0.001	0.014	0.002	0.076	0.001	0.008	
M2426	2	0.18	0.002	0.011	8.83	0.107	0.184	0.072	0.011	0.048	0.037	0.164	0.002	0.046	0.002	0.05	0.062	0.004	<0.001	<0.001	0.001	<0.001	0.037	0.085	0.078	0.043	0.004	<0.001	0.01	0.001	0.037	<0.001	0.004	
M2427	3	0.111	0.005	0.061	16.28	0.253	0.392	0.273	0.027	0.122	0.151	0.415	0.015	0.079	0.009	0.127	0.139	0.01	0.001	0.003	0.002	<0.001	0.028	0.099	<0.001	0.102	0.007	<0.001	0.007	0.001	0.081	<0.001	0.011	
M2428	4	0.185	0.005	0.015	26.54	0.348	0.63	0.271	0.041	0.189	0.126	0.26	0.022	0.05	0.004	0.177	0.213	0.013	0.001	0.01	0.002	<0.001	0.026	0.046	0.081	0.157	0.01	<0.001	0.002	0.002	0.133	0.001	0.016	
M2429	5	0.167	0.003	0.006	6.273	0.099	0.168	0.056	0.017	0.06	0.053	0.165	<0.001	0.185	0.001	0.039	0.062	0.004	<0.001	<0.001	0.001	<0.001	0.005	0.02	0.072	0.051	0.003	<0.001	0.002	0.001	0.033	<0.001	0.006	
M2430	6	0.084	<0.001	0.067	0.409	0.01	0.007	0.137	0.01	<0.001	0.113	0.17	0.001	0.146	<0.001	0.018	0.072	0.001	<0.001	<0.001	0.001	<0.001	0.002	0.014	<0.001	0.002	0.001	<0.001	0.005	0.001	0.009	<0.001	<0.001	
M2431	7	0.034	0.001	0.015	3.777	0.085	0.087	0.119	0.008	0.038	0.076	0.207	0.002	0.109	<0.001	0.057	0.06	0.003	<0.001	<0.001	0.001	<0.001	0.02	0.07	0.11	0.028	0.002	<0.001	<0.001	<0.001	0.017	<0.001	0.003	
M2432	8	0.116	0.003	0.027	16.56	0.22	0.379	0.249	0.029	0.143	0.108	0.424	0.012	0.155	0.001	0.097	0.169	0.007	<0.001	0.003	0.001	<0.001	0.04	0.034	<0.001	0.107	0.006	<0.001	0.003	0.001	0.079	<0.001	0.01	
M2433	9	0.177	<0.001	0.099	0.149	0.025	0.004	0.332	0.009	0.003	0.015	0.17	0.003	1.726	0.015	0.023	0.498	<0.001	<0.001	<0.001	<0.001	<0.001	0.005	0.027	<0.001	0.002	<0.001	0.012	<0.001	0.004	<0.001	<0.001		
M2434	10	0.225	0.002	0.042	4.608	0.079	0.127	0.03	0.009	0.03	0.019	0.062	0.009	0.876	0.015	0.037	0.115	0.001	<0.001	<0.001	0.001	<0.001	<0.001	0.013	<0.001	0.033	0.002	0.001	0.006	0.001	0.025	<0.001	0.002	
M2435	11	0.259	0.002	0.025	5.744	0.096	0.165	0.048	0.012	0.046	0.044	0.219	0.005	0.891	0.003	0.04	0.136	0.003	<0.001	<0.001	0.001	<0.001	<0.001	0.099	0.044	0.043	0.002	<0.001	<0.001	0.001	0.032	<0.001	0.003	
M2436	12	6.587	0.005	0.024	13.96	0.252	0.438	0.117	0.03	0.126	0.07	0.211	0.02	0.614	<0.001	0.087	0.219	0.004	0.001	0	0.001	<0.001	<0.001	0.062	<0.001	0.119	0.004	<0.001	<0.001	0.001	0.078	<0.001	0.007	
M2437	13	0.108	<0.001	0.07	0.039	0.041	0.005	3.033	0.058	0.187	0.017	1.135	0.003	3.643	0.022	0.042	0.888	0.001	0.001	0.001	<0.001	0.003	0.049	<0.001	<0.001	<0.001	<0.001	0.004	0.001	0.004	<0.001	<0.001		
M2438	14	0.153	0.004	0.052	0.014	0.062	0.009	3.793	0.149	0.225	0.075	0.728	0.015	4.871	0.036	0.076	1.998	<0.001	0.001	<0.001	<0.001	<0.001	0.003	0.199	<0.001	0.024	<0.001	<0.001	0.002	0.001	0.007	<0.001	<0.001	
M2439	15	0.279	0.004	0.058	0.008	0.09	0.012	0.196	0.008	0.013	0.017	0.154	0.02	5.905	0.056	0.049	0.178	<0.001	0.001	<0.001	<0.001	<0.001	<0.001	0.012	0.053	0.001	<0.001	<0.001	0.001	0.002	<0.001	<0.001		
M2440	16	0.363	<0.001	0.039	0.006	0.032	0.008	0.054	0.001	<0.001	0.002	0.272	0.006	2.436	0.017	0.025	0.072	0.002	<0.001	<0.001	<0.001	<0.001	<0.001	0.053	<0.001	<0.001	<0.001	<0.001	<0.001	<0.001	<0.001	<0.001		
M2441	17	0.099	0.001	0.055	2.425	0.05	0.071	0.075	0.007	0.018	0.033	0.254	<0.001	1.231	<0.001	0.027	0.054	0.002	<0.001	0.001	<0.001	<0.001	<0.001	0.021	<0.001	0.025	0.001	<0.001	<0.001	0.001	0.014	<0.001	0.001	
M2442	18	0.081	0.001	0.067	0.07	0.019	0.008	0.172	0.005	0.015	0.039	0.692	0.004	1.193	0.011	0.012	0.045	0.001	<0.001	<0.001	<0.001	<0.001	<0.001	0.007	<0.001	0.001	<0.001	0.003	<0.001	<0.001	0.002	<0.001	<0.001	
M2443	19	0.018	0.001	0.002	2.35	0.047	0.06	0.107	0.004	0.016	0.029	0.074	0.003	0.115	0.004	0.034	0.033	0.001	<0.001	<0.001	<0.001	<0.001	0.004	0.109	0.019	0.017	0.001	<0.001	<0.001	0.011	<0.001	0.002		
M2444	20	0.305	0.001	0.007	6.054	0.116	0.154	0.107	0.01	0.045	0.041	0.234	0.008	0.131	<0.001	0.04	0.082	0.003	<0.001	<0.001	0.001	<0.001	0.031	0.02	0.014	0.047	0.002	<0.001	<0.001	0.032	<0.001	0.003		
M2445	21	0.038	0.001	0.011	2.88	0.114	0.073	0.164	0.007	0.023	0.049	0.145	0.009	0.205	0.002	0.024	0.026	0.015	<0.001	<0.001	0.001	<0.001	0.002	0.042	<0.001	0.023	0.001	<0.001	<0.001	0.016	<0.001	0.007		
M2446	22	0.203	0.003	0.005	7.542	0.176	0.197	0.294	0.018	0.058	0.143	0.357	0.012	0.104	0.01	0.045	0.078	0.003	0.003	<0.001	0.001	<0.001	<0.001	0.105	0.094	0.062	0.002	<0.001	<0.001	0.051	<0.001	0.01		
M2447	23	0.015	<0.001	0.002	2.079	0.055	0.056	0.091	0.004	0.022	0.067	0.276	0.003	<0.001	0.007	0.056	0.202	0.004	<0.001	<0.001	<0.001	<0.001	0.005	0.018	0.071	0.017	0.001	<0.001	<0.001	0.016	<0.001	0.002		
M2448	24	0.154	0.004	0.012	14.06	0.232	0.449	0.212	0.027	0.173	0.102	0.456	0.016	0.051	0.002	0.116	0.213	0.006	0.001	0.002	0.002	<0.001	0.017	0.034	0.12	0.134	0.006	<0.001	<0.001	0.001	0.092	<0.001	0.01	
M2449	25	0.032	0.001	0.056	3.767	0.084	0.081	0.307	0.012	0.083	0.066	0.309	0.011	0.031	0.01	0.057	0.127	0.004	0.001	<0.001	0.001	<0.001	0.039	0.02	<0.001	0.034	0.001	<0.001	<0.001	0.026	<0.001	0.002		
M2450	26	0.066	<0.001	0.066	2.619	0.102	0.069	0.209	0.008	0.033	0.044	0.169	0.007	0.069	0.004	0.038	0.076	0.004	<0.001	<0.001	0.001	<0.001	0.042	0.058	<0.001	0.023	0.001	<0.001	<0.001	0.018	<0.001	0.002		
M2451	27	0.016	<0.001	0.003	2.833	0.048	0.047	0.254	0.006	0.028	0.047	0.15	0.006	0.006	0.012	0.037	0.028	0.009	<0.001	<0.001	<0.001	<0.001	0.034	0.016	<0.001	0.019	0.001	0.001	<0.001	0.017	<0.001	0.002		
M2452	28	0.015	<0.001	0.049	1.474	0.022	0.022	0.08	0.003	0.02	0.019	0.156	<0.001	<0.001	0.001	0.019	0.015	0.002	<0.001	<0.001	0.001	<0.001	0.082	0.023	<0.001	0.008	<0.001	<0.001	<0.001	0.007	<0.001	0.001		
M2453	29	0.015	0.001	0.071	3.864	0.056	0.064	0.131	0.008	0.031	0.048	0.069	0.007	0.029	0.004	0.046	0.038	0.001	<0.001	<0.001	0.001	<0.001	0.092	0.027	<0.001	0.03	0.002	<0.001	<0.001	0.028	<0.001	0.003		
M2454	30	0.015	<0.001	0.006	2.491	0.041	0.039	0.06	0.005	0.011	0.028	0.213	<0.001	0.012	<0.001	0.024	0.02	<0.001	<0.001	<0.001	<0.001	<0.001	0.152	0.048	0.027	0.015	0.001	<0.001	<0.001	0.013	<0.001	0.002		
M2455	31	0.01	<0.001	0.056	3.252	0.046	0.044	0.392	0.01	0.05	0.029	0.076	<0.001	0.023	0.01	0.049	0.031	0.001	<0.001	<0.001	<0.001	<0.001	0.029	0.058	<0.001	0.022	0.001	0.001	<0.001	<0.001	0.019	<0.001	0.002	
M2456	32	0.375	<0.001	0.066	3.496	0.04	0.045	0.106	0.006	0.024	0.022	0.115	<0.001	0.017	<0.001	0.033	0.029	0.004	<0.001	<0.001	<0.001	<0.001	0.071	0.025	<0.001	0.022	0.001	0.001	0.002	<0.001	0.017	<0.001	0.001	
M2457	33	0.013	0.001	0.065	4.463	0.087	0.076	0.531	0.012	0.026	0.036	0.04	<0.001	0.07	0.017	0.056	0.044	0.002	<0.001	<0.001	<0.001	<0.001	0.04	0.385	<0.001	0.035	0.001	<0.001	<0.001	0.027	<0.001	0.003		
M2458	34	0.006	<0.001	0.017	2.064	0.032	0.029	0.068	0.003	<0.001	0.02	0.035	<0.001	<0.001	<0.001	0.016	0.017	<0.001																

mg/kg	Sender ID	7Li	9Be	11B	47Ti	51V	52Cr	55Mn	59Co	60Ni	65Cu	66Zn	75As	79Br	82Se	85Rb	88Sr	95Mo	111Cd	118Sn	121Sb	125Te	127I	133Cs	137Ba	139La	182W	195Pt	202Hg	205Tl	208Pb	209Bi	238U
M2504	80	0.24	0.013	0.011	24.11	0.46	0.58	0.665	0.052	0.158	0.14	0.202	0.033	0.163	0.008	0.119	0.224	0.007	0.001	0.005	0.002	<0.001	0.003	<0.001	0.163	0.315	0.008	<0.001	<0.001	0.002	0.156	<0.001	0.042
M2505	81	0.079	0.003	<0.001	10.08	0.243	0.308	0.723	0.024	0.094	0.058	0.161	0.018	0.048	0.012	0.104	0.13	0.004	<0.001	0.003	0.001	<0.001	0.012	<0.001	0.056	0.107	0.005	<0.001	<0.001	0.001	0.061	<0.001	0.011
M2506	82	0.117	0.004	<0.001	23.85	0.368	0.505	0.394	0.033	0.649	0.096	0.216	0.03	0.091	0.012	0.111	0.193	0.006	<0.001	0.007	0.002	<0.001	0.035	<0.001	0.07	0.178	0.009	<0.001	<0.001	0.001	0.103	<0.001	0.018
M2507	83	0.129	0.004	0.001	18.59	0.327	0.427	0.46	0.023	0.103	0.064	0.164	0.033	0.065	0.003	0.113	0.163	0.006	<0.001	<0.001	0.002	<0.001	0.009	<0.001	0.068	0.078	0.006	<0.001	<0.001	0.001	0.078	<0.001	0.017
M2508	84	0.16	0.004	0.003	24.43	0.426	0.578	0.321	0.031	0.136	0.078	0.143	0.04	0.075	0.011	0.127	0.129	0.008	<0.001	0.006	0.006	<0.001	0.013	<0.001	0.082	0.168	0.01	<0.001	<0.001	0.001	0.108	<0.001	0.022
M2509	85	0.173	0.013	0.032	17.29	0.308	0.495	0.711	0.043	0.141	0.148	0.256	0.031	0.977	0.021	0.14	0.228	0.007	<0.001	<0.001	0.002	<0.001	0.01	<0.001	0.096	0.289	0.006	<0.001	<0.001	0.002	0.158	<0.001	0.049
M2510	86	0.203	0.008	0.04	13.04	0.304	0.545	0.279	0.03	0.137	0.101	0.17	0.026	0.491	0.003	0.118	0.162	0.007	<0.001	0.003	0.002	<0.001	0.003	<0.001	0.063	0.206	0.007	<0.001	<0.001	0.001	0.139	<0.001	0.045
M2511	87	0.017	0.001	<0.001	4.081	0.053	0.058	0.302	0.005	0.044	0.037	0.116	0.002	0.031	0.005	0.052	0.034	0.001	<0.001	<0.001	0.001	<0.001	0.002	<0.001	0.014	0.034	0.001	<0.001	0.001	<0.001	0.015	<0.001	0.003
M2512	88	0.093	0.006	0.006	24.26	0.301	0.401	0.527	0.029	0.135	0.095	0.151	0.015	0.068	0.013	0.135	0.164	0.007	<0.001	0.004	0.002	<0.001	0.021	<0.001	0.085	0.244	0.008	<0.001	<0.001	0.001	0.122	<0.001	0.019
M2513	89	0.04	0.002	<0.001	11.33	0.139	0.189	0.298	0.015	0.185	0.064	0.188	0.009	0.057	<0.001	0.074	0.073	0.004	<0.001	<0.001	0.002	<0.001	0.018	<0.001	0.028	0.079	0.004	<0.001	<0.001	0.001	0.044	<0.001	0.007
M2514	90	0.084	0.004	<0.001	23.6	0.281	0.425	0.065	0.029	0.159	0.1	0.202	0.021	0.1	0.009	0.123	0.155	0.007	<0.001	0.004	0.002	<0.001	0.035	<0.001	0.069	0.221	0.007	<0.001	<0.001	0.001	0.104	<0.001	0.017
M2515	91	0.486	0.013	0.022	16.09	0.315	0.496	0.253	0.041	0.148	0.112	0.194	0.013	1.084	0.01	0.09	0.197	0.005	<0.001	0.005	0.003	<0.001	0.008	<0.001	0.077	0.468	0.009	<0.001	0.002	0.128	<0.001	0.042	
M2516	92	0.079	<0.001	0.008	0.538	0.008	0.005	0.004	0.001	<0.001	<0.001	0.041	0.001	0.853	0.004	0.005	0.025	<0.001	<0.001	<0.001	<0.001	<0.001	0.01	<0.001	0.002	0.004	<0.001	<0.001	<0.001	<0.001	<0.001	<0.001	0.001
M2517	93	0.03	0.002	0.032	4.276	0.087	0.122	0.053	0.006	0.02	0.041	0.061	0.005	0.082	0.004	0.029	0.04	0.003	<0.001	<0.001	0.001	<0.001	0.021	<0.001	0.02	0.095	0.005	<0.001	0.01	0.001	0.044	<0.001	0.014
M2518	94	0.023	0.001	0.026	3.636	0.059	0.084	0.026	0.004	0.013	0.042	0.057	0.004	0.077	0.006	0.015	0.018	0.002	<0.001	<0.001	<0.001	<0.001	0.013	<0.001	0.009	0.051	0.004	<0.001	0.007	<0.001	0.019	<0.001	0.008
M2519	95	0.061	0.017	0.033	4.406	0.16	0.159	0.383	0.019	0.132	0.106	0.105	0.007	0.046	<0.001	0.039	0.171	0.003	<0.001	<0.001	0.002	<0.001	0.006	0.005	0.189	0.357	0.003	<0.001	0.005	0.001	0.109	<0.001	0.052



February 2018

REPORT – VOLUME 4, STUDY 4B



CNOOC UGANDA LIMITED

KINGFISHER OIL PROJECT, HOIMA DISTRICT, UGANDA - IRRIGATION POTENTIAL ASSESSMENT

Submitted to:

The Executive Director National Environment Management Authority, NEMA House,
Plot 17/19/21 Jinja Road, P. O. Box 22255 Kampala, Uganda



Report Number: 1776816-323373-20

Distribution:

- 1 x electronic copy CNOOC Uganda Limited
- 1 x electronic copy NEMA
- 1 x electronic copy Eco & Partner
- 1 x electronic copy Golder





Executive Summary

Golder Associates Africa (Pty) Ltd requested during October 2017 an update on certain soil aspects related to the Kingfisher Baseline Soil Assessment conducted in 2014. The update includes the soil mapping reflecting the *South African Taxonomical Classification System* that need to be changed to *FAO Classification System*. The pipeline route changed with nominal changes at the northern end of the pipeline route and reasonable deviation from the original base corridor at the southern end of the pipeline and need to be addressed in terms of soils. An assessment of the irrigation suitability of 45m³/day sewage effluent on soils immediately around the CPF.

From the update it is conclusive the dominant soils on the Buhuka Flats study area according to the FAO Soil Classification System include *Ferrasols*, *Litosols*, *Gleysols* and *Vertisols*. The *Ferrasols* is most suitable for the irrigation of 45m³/day sewage effluent. CNOOC would not want to irrigate far away due to pumping and piping costs. Irrigation would essentially have to be in close proximity to the permanent accommodation area. *i.e.* the Ferrasols occur near the CPF. A 3 to 5ha area in close proximity to the CPF would enable enough even distribution and rotation of 45m³/day sewage effluent to maintain plant available water between 33 – 1,500kPa. An indigenous pasture should be identified that would be suitable and sustainable for 45m³/day sewage effluent irrigation purposes.

The **45m³/day sewage effluent** should be carefully monitored to ensure:

- pH 5,3 and 7,2 (*no acid and/or alkaline anomalies*), EC<250mS/m, SAR<15 – maintain SAR<10 to ensure buffercapacity, assess toxicity of trace elements for specific pasture species utilized for irrigation, prevent eutrophication in soil through excess nitrogen and phosphorus being irrigated, no human and/or plant pathogens become an environmental risk.

The **3 – 5ha Ferrasols** should be carefully monitored to ensure:

- pH 5,3 and 7,2 (*1:2.5 soil:water ratio*) in soil solution, EC<250mS/m (*saturated water extract*), ESP<15 (*1N NH4-Ac extract pH7*) – maintain ESP<10 to ensure buffercapacity, Ca: 200 – 4,000mg/kg (*1N NH4-Ac extract pH7*), Mg: 50 – 500mg/kg (*1N NH4-Ac extract pH7*), K: 20 – 300mg/kg (*1N NH4-Ac extract pH7*), Ca:Mg (1,5 – 4,5), Mg:K (3 – 4) and Ca+Mg/K (10 – 20) (*1N NH4-Ac extract pH7*), NO₃: 10-20mg/kg (*saturated water extract*), P: 10- 15mg/kg (*Bray 1 extract*), Heavy metals: <0.01mg/kg (*saturated water extract*), SO₄, Cl, B, F: <0,1mg/kg (*saturated water extract*), No human and/or plant pathogens become an environmental risk, Infiltration capacity: 10- 15mm/h @ bulk density 1,275kg/m³ (*no crust formation*) and C:N Ratio: 1:10.

It should be considered to compile a soil water balance with the chosen pasture species under the climatic condition of the Buhuka Flats to optimize irrigation scheduling.

The 3 – 5ha Ferralsol soil system at 1,500kg/m³/300mm bulk density contains an estimated 13,500,000 to 22,500,000kg soil. The average CEC range between 5 – 15cmol+/kg (*1N NH4-Ac extract pH7*), which is an enormous advantage in terms of buffercapacity to utilize for 45m³/day sewage effluent irrigation in combination with plant root uptake of nutrients. However, it must be stressed the system should be carefully monitored and maintained to prevent contamination. Soil remediation cost could be as high as \$800/m³ (\$12,000,000/15,000,000m³ soil @ BD1,500kg/m³/300mm) depending on the severity of remediation required (*e.g. ESP>15% requires leaching Na with Ca*), this excludes site establishment of earth moving equipment (if necessary).



Table of Contents

1.0 TERMS OF REFERENCE..... 2

2.0 INVESTIGATION OBJECTIVES..... 3

3.0 METHOD OF INVESTIGATION..... 3

4.0 PROBLEM ANALYSES..... 4

 4.1 FAO Classification System 4

 4.1.1 Ferrasols 7

 4.1.2 Litosols 7

 4.1.3 Gleysols..... 7

 4.1.4 Vertisols..... 7

 4.2 Irrigation Potential Of Soils 8

 4.2.1 Infiltration and Surface Runoff 8

 4.2.2 Irrigation Management For Salt Control 9

 4.2.3 Irrigation Methods In Relation To Salinity Control 9

 4.2.4 Properties of Irrigation Water 11

5.0 CONCLUSIONS 12

TABLES

Table 1: FAO Soils Diagnostic Criteria 5

FIGURES

Figure 1: Kingfisher Study Area.....2

Figure 2: Soils: Taxonomical Classification System.....2

Figure 3: Changes to pipeline route 3

Figure 4: Kingfisher Area FAO Soil Types 4

Figure 5: Pipeline FAO Soil Types 4

Figure 6: 1:1 and 2:1 clay mineralogy (fraction <0,002mm)6

Figure 7: Typical Foundation Indicator Data for soils containing 1:1 (left) and 2:1 (right) clay mineralogy6

Figure 8: Typical Water Balance 8

Figure 9: SAR relative to EC..... 11

Figure 10: SAR relative to ESP 12





ACRONYMS AND ABBREVIATIONS

CNOOC	China National Offshore Oil Corporation
CPF	Central Processing Facility
EBS	Environmental Baseline Study
EIA	Environmental Impact Assessment
EIS	Environmental Impact Statement
ESIA	Environmental and Social Impact Assessment
ESMP	Environmental and Social Management Plan
GIS	Geographic information system
Golder	Golder Associates Africa (Pty) Ltd
Ha	Hectares
IFC	International Finance Corporation
KF	Kingfisher
M	Meters
SOW	Scope of Work
TOR	Terms Of Reference

DEFINITIONS OF TERMINOLOGY

Auger	A tool for boring the soil and withdrawing small increments for field observation and sampling
Cation	A positively charged ion, for example Na ⁺ , Ca ²⁺ , Al ³⁺ . The term exchangeable base cations ordinarily refers to calcium, magnesium, potassium and sodium
Consistence	The degree of cohesion or adhesion within the soil mass or its resistance to deformation rupture
Electrical Conductivity (EC)	A measure of the ability of a material to conduct current and is a measure of the concentration of salts in solution
Ferralsols	Soils with an oxic B – Horizon. Hard laterite is common in these soils.
Gleysols	Very wet soils formed in unconsolidated materials excluding recent alluvium.
Horizon	A layer of soil or soil approximately parallel to the land surface and differing from adjacent genetically related layers in physical, chemical and biological properties or characteristics
Lithosols	Shallow soils with continuous hard rock within 100mm of the soil surface.
Particle(Fraction) distribution/size	The percentage of each size fraction into which a dispersed sample of a soil has been separated, i.e. sand silt and clay.
pH	The degree of acidity of a soil expressed in terms of the pH scale (1-14)
Soil profile	A vertical section of the soil through all its horizons and extending to the underlying material
Soil texture	The relative proportions or the various separates (san, clay silt) in the soil
Structure	The arrangement of primary soil particles into secondary units or peds, usually giving a distinctive characteristic pattern
Vertisols	Dark coloured soils with high clay content and one or more of: cracks wider than 100mm in the dry state, gilgai micro-relief, slickensides, wedge-shaped peds.



1.0 TERMS OF REFERENCE



Figure 1: Kingfisher Study Area

During October 2017 *Golder Associates Africa (Pty) Ltd* requested an update on certain soil aspects related to the Kingfisher Baseline Soil Assessment (Figure 1) conducted in 2014. It includes:



Figure 2: Soils: Taxonomical Classification System

- The soil mapping (Figure 2) reflects South African Taxonomical Classification System and needs to be changed to FAO Classification System.

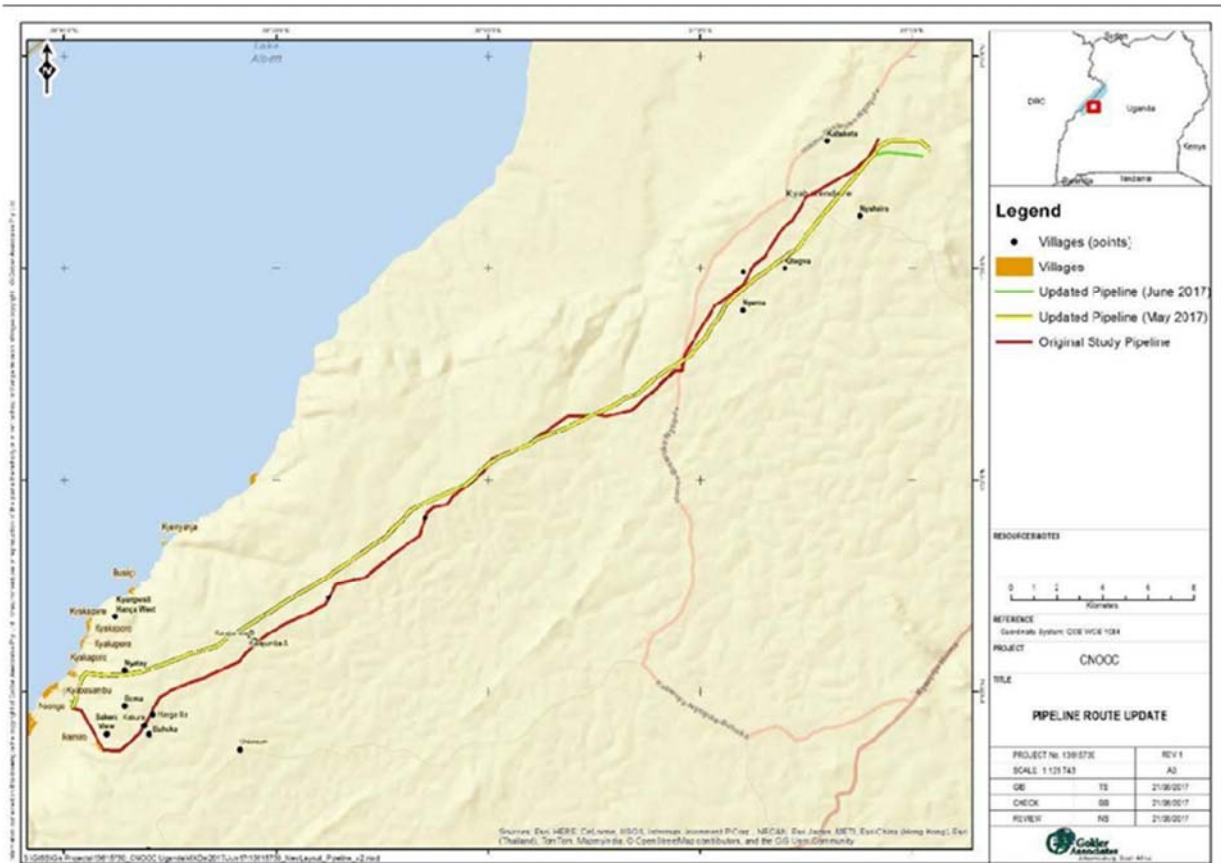

Figure 3: Changes to pipeline route

- The pipeline route has changed with nominal changes at the northern end of the pipeline route and reasonable deviation from the original base corridor at the southern end of the pipeline.
- Assessment of the irrigation suitability of 45m³/day sewage effluent on soils immediately around the CPF. CNOOC would not want to irrigate far away due to pumping and piping costs so the irrigation would essentially have to be in close proximity to the permanent accommodation area.

2.0 INVESTIGATION OBJECTIVES

The objectives of the investigation were interpreted as:

- Convert soils classified in the Taxonomical Soil Classification System to FAO System.
- Assess the irrigation potential of 45m³/day sewage effluent on soils immediately around the CPF.

3.0 METHOD OF INVESTIGATION

To meet the objectives of the investigation the following scope of work was followed:

- Correlating soils classified according to the Taxonomical Soil Classification System of South Africa with **FAO Classification System**.
- Assess **irrigation potential of soils**.
- Review **chemical quality of sewage effluent and its effect on soils during irrigation at 45m³/day**.





4.0 PROBLEM ANALYSES

4.1 FAO Classification System

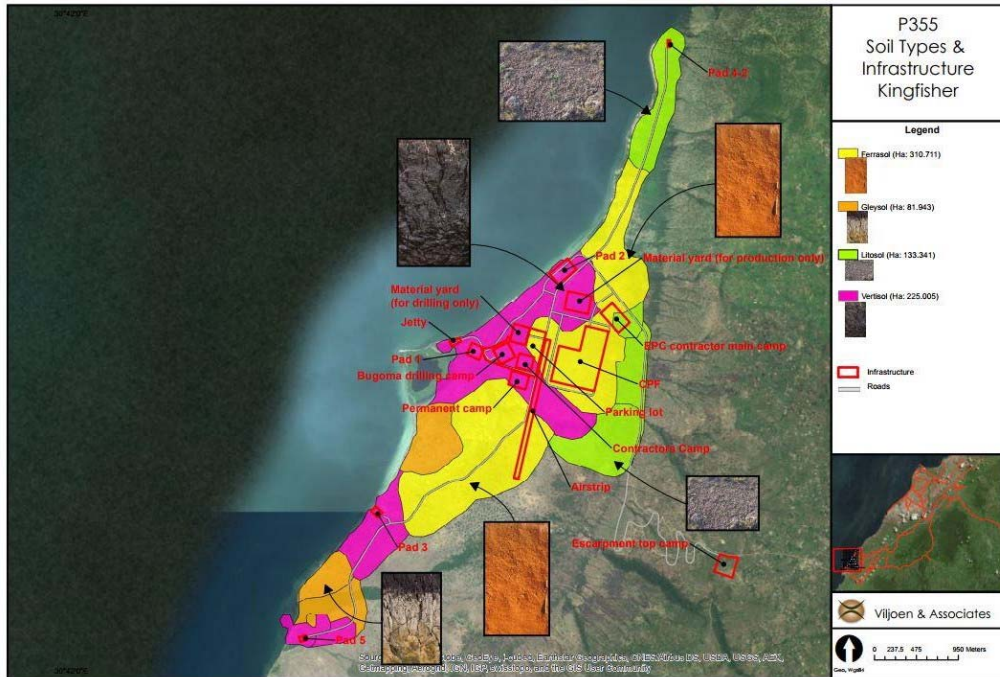

Figure 4: Kingfisher Area FAO Soil Types



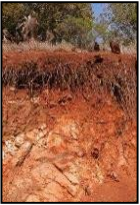



Figure 5: Pipeline FAO Soil Types



Table 1 summarises the diagnostic criteria of the different soil types:

Table 1: FAO Soils Diagnostic Criteria

Soil Type	Diagnostic Criteria
<p>Ferrasols</p> 	<ul style="list-style-type: none"> ■ Well drained soils. ■ Red or yellow-brown colour. ■ Has clay textures. ■ Ferrasol is usually associated with previous volcanic activity. ■ Used for intensive crop production.
<p>Gleysols</p> 	<ul style="list-style-type: none"> ■ Associated with wetland conditions. ■ Is usually saturated with groundwater. ■ Usually covered with swamp vegetation. ■ In the tropics and subtropics they are cultivated for rice or, after drainage, for field crops and trees. ■ Characterised by both chemical and visual evidence of iron reduction. ■ Red, yellow, or brown mottles may be seen.
<p>Litosols</p> 	<ul style="list-style-type: none"> ■ Shallow soils on weathered geology. ■ Lack well defined horizons.
<p>Vertisols</p> 	<ul style="list-style-type: none"> ■ High clay content soil, shrinks and swells dramatically under fluctuating soil moisture contents. ■ When dry form large cracks that may be more than one meter (<i>three feet</i>) deep and several centimetres (<i>inches</i>) wide. Movement of these soils can crack building foundations and buckle roads. ■ Highly fertile due to the high clay content. ■ Depending on the parent material and climate, soils can range from grey or red to the more familiar deep black.



IRRIGATION POTENTIAL ASSESSMENT

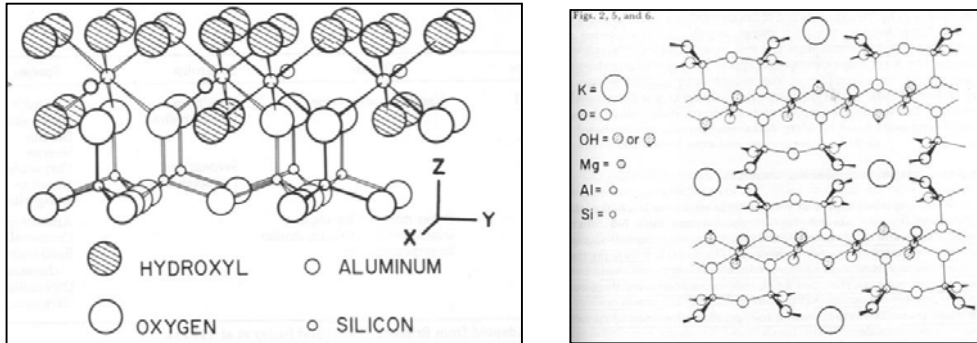

Figure 6: 1:1 and 2:1 clay mineralogy (fraction <0,002mm)

From a particle size distribution perspective, the fraction smaller than 0,002mm (Figure 6) can be used to separate the Ferrasols, Gleysols Litosols and Vertisols into two distinctive groups in terms of chemical, physical and mechanical behavior:

Group 1: 1:1 clay mineralogy

- Ferrasols, Litosols

Group 2: 2:1 clay mineralogy

- Gleysols, Vertisols

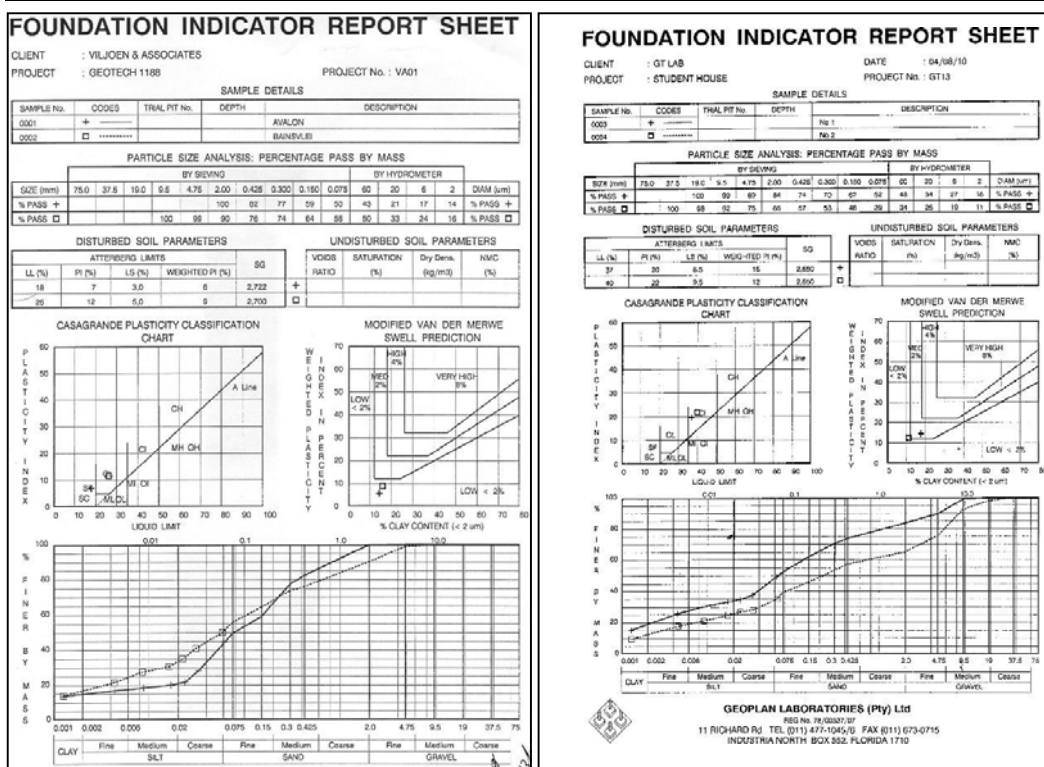

Figure 7: Typical Foundation Indicator Data for soils containing 1:1 (left) and 2:1 (right) clay mineralogy





Figure 7 illustrates typical foundation indicator data for *Group 1* soils containing 1:1 clay mineralogy (e.g. kaolinite) and *Group 2* soils containing 2:1 clay mineralogy (e.g. smectite). The plasticity index (PI) represents the different soil's ability to swell and shrink under fluctuating moisture regimes.

4.1.1 Ferrasols

These are soils with an Oxid-B horizon, at least 300 mm thick. Typical properties are the presence of 1:1 clays, hydrated oxides of iron and aluminium, a low cation exchange capacity (<10cmol+/kg clay at pH7). The main processes of soil formation are weathering, humification and pedoturbation due to animals. The soils are characterised by a red (*Fe oxidised*) or yellowish (*Fe reduced*) colour, due to the high concentration of iron(III) and aluminium oxides and hydroxides. If the exchangeable sodium percentage (ESP) exceeds 15% of the cation exchange capacity (CEC @ pH7 1NH4-Ac Extract) dispersion in the diffuse double layer around the clay particles will take place and cause soil erosion. The bulk density is on average 1,275kg/m³ and quantity (15%) of 1:1 clay mineralogy makes handling of the soil easy. The soil is suitable for agricultural production under dryland and irrigation conditions.

4.1.2 Litosols

Shallow soils with continuous hard rock within 100mm of soil surface. Soils that do not show any profile development other than an A horizon, has no diagnostic horizons, and most are basically unaltered from their parent material, which can be unconsolidated sediment or rock. Soil erosion will take place if the exchangeable sodium percentage (ESP) exceeds 15% of the cation exchange capacity (CEC @ pH7 1NH4-Ac Extract). The bulk density of the topsoil layer is on average 1,275kg/m³ and quantity (15%) of 1:1 clay mineralogy makes handling of the soil easy. The soil is not suitable for agricultural production under dryland and irrigation conditions.

4.1.3 Gleysols

Wet soils formed in unconsolidated materials developed to 450 – 600mm deep. These soils are wetland soils (hydric soil) that, unless drained, is saturated with groundwater for long enough periods to develop a characteristic gleyic colour pattern. This pattern is essentially made up of reddish, brownish or yellowish colours at surfaces of soil particles (peds) and/or in the upper soil horizons mixed with greyish/blueish colours inside the peds and/or deeper in the soil. Soil erosion occurs when the exchangeable sodium percentage (ESP) exceeds 15% of the cation exchange capacity (CEC @ pH7 1NH4-Ac Extract). The bulk density is on average 1,800kg/m³ and quantity (>25%) of 2:1 clay mineralogy makes handling of the soil difficult. The soil is not suitable for agricultural production under dryland conditions.

4.1.4 Vertisols

Dark coloured soils with high clay content, cracks wider than 100mm in dry state, gilgai micro-relief, slickensides, wedge-shaped peds. A high content of expansive clay known as montmorillonite that forms deep cracks in drier seasons or years. Alternate shrinking and swelling causes self-mulching, where the soil material consistently mixes itself, causing vertisols to have an extremely deep A horizon (300 – 900mm) and no B horizon. Vertisols typically form from highly basic rocks, such as basalt, in climates that are seasonally humid or subject to erratic droughts and floods, or to impeded drainage. Depending on the parent material and the climate, they can range from grey or red to the more familiar deep black. The shrinking and swelling of vertisols can damage buildings and roads, leading to extensive subsidence. When the exchangeable sodium percentage (ESP) exceeds 15% of the cation exchange capacity (CEC @ pH7 1NH4-Ac Extract) dispersion in the diffuse double layer around the clay particles takes place and result in soil erosion. The bulk density is on average 1,800kg/m³ and quantity (>25%) of 2:1 clay mineralogy makes handling of the soil difficult. The soil is suitable for agricultural production under dryland conditions, however careful planning is required for irrigation scheduling of high clay content vertisols.



4.2 Irrigation Potential Of Soils

4.2.1 Infiltration and Surface Runoff

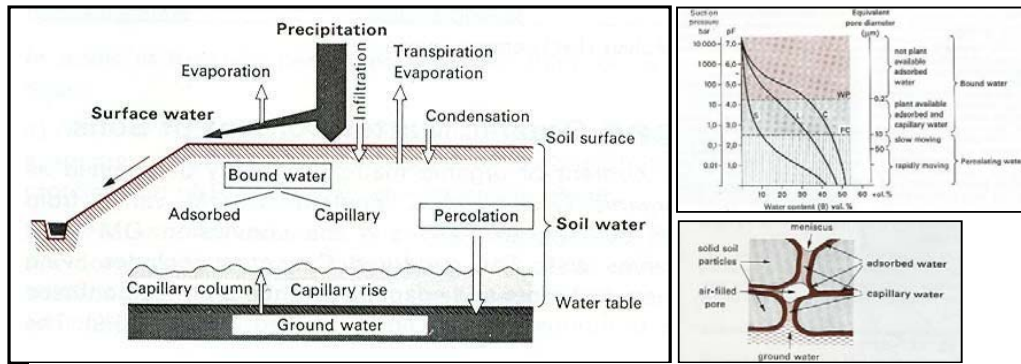

Figure 8: Typical Water Balance

When water is supplied to soil surface (*precipitation & irrigation*) (**Figure 8**), some of the arriving water penetrates the surface and is absorbed into the soil, while some may fail to penetrate but instead accrue at the surface or flow over it. The water which does penetrate is itself later partitioned between the amount which returns to the atmosphere by evapotranspiration and the portion which seeps downward, with some of the latter re-emerging as streamflow while the remainder recharges the ground water reservoir.

Infiltration is the term applied to the process of water entry into the soil, generally by downward flow through all or part of the soil surface. Water may enter the soil through the entire surface uniformly as under ponding or rain or may enter the soil through furrows or crevices. It may also move up into the soil from a source below (e.g. high water table). The rate of this relative to the rate of water supply determines how much water will enter the root zone and how much if any will run off. The rate of infiltration affects not only water economy of plant communities, but also the amount of surface runoff and its attendant danger of soil erosion.

Where the rate of infiltration is restricted, plants may be denied sufficient moisture while the amount of erosion increases. Knowledge of the infiltration process as it is affected by the soil's properties and transient conditions and mode of water supply is therefore a prerequisite for efficient soil and water management.

If water is sprinkled over the soil surface at a steady increasing rate, sooner or later the rising supply rate will exceed the soil's limited rate of adsorption, and the excess will accrue over the soil surface or run off it. The *infiltration rate* is defined as the volume flux of water flowing into the profile per unit of soil surface area. This flux is referred to *infiltration velocity*.

Infiltration depends on the following factors:

- **Time from the onset of rain or irrigation.** The infiltration rate is apt to be relatively high at first, then to decrease and eventually to approach a constant rate that is characteristic for the soil profile.
- **Initial water content.** The wetter the soil is initially, the lower will be the infiltrability (smaller suction gradients) and quicker will be the attainment of the final (constant) rate, which itself is generally independent of the initial water content.
- **Hydraulic conductivity.** The higher the saturated hydraulic conductivity of the soil is, the higher its infiltrability tends to be.
- **Soil surface conditions.** When the soil surface is highly porous and open structure the initial infiltrability is greater than that of a uniform soil, but the final infiltrability remains unchanged, as it is limited by the lower conductivity of the transmission zone beneath. When the soil surface is compacted and the profile covered by a surface crust of lower conductivity the infiltration rate is lower than that of the uncrusted (uniform) soil. The surface crust acts as a hydraulic barrier impeding infiltration. This effect,





which becomes more pronounced with a thicker and denser crust, reduces both the initial infiltrability and eventually attained steady infiltrability. A soil of unstable structure tends to form such a crust during infiltration, especially as the result of the slacking action of beating raindrops. In such a soil, a plant cover or a surface mulch of plant residues can serve to intercept and break the impact of the raindrops and help to prevent sealing.

- **The presence of impeding layers inside the profile.** Layers which differ in texture or structure from the overlaying soil may retard water movement during infiltration. Clay layers and sand layers can have a similar effect, although for opposite reasons. The clay layer impedes flow owing to its lower saturated conductivity, while a sand layer retards the wetting front where unsaturated conditions prevail owing to the lower unsaturated conductivity of the sand at equal matric suction. Flow into a dry sand layer can take place only after the pressure head has build up sufficiently for water to move into and fill the large pores of the sand.

4.2.2 Irrigation Management For Salt Control

The primary parameters that needs to be considered to ensure effective irrigation management for salt control are the water requirement of the crop and the quality of the irrigation water. Correct irrigation should restore any soil water deficit, while avoiding the application of a wasteful and potentially harmful excess water. An excess may be deliberately applied to control salt levels.

Plant growth is a function of the salinity and matric potential of soil water. Salinity is controlled by leaching, matrix potential is controlled by adequate and timely water application. Soluble salts contained in irrigation water are concentrated in the soil solution by soil evaporation and plant transpiration. Soluble salts are transported by water and salinity control depends on the quality of the irrigation water and on the amount and direction of the water flow. Plant water uptake and surface evaporation may cause an upward flow, a process by which many soils become salinized, especially when the water table is near the soil surface. The net water movement is downward and salts are leached from the root zone when more water is applied than is used during a crop season.

Over time the amount of salt removed by leaching must suffice to prevent the build-up of salinity beyond the level the crop can tolerate. It was once thought to amount removed had to be equal to the amount applied in the irrigation water. However, research have shown the amount of leached salt can be modified by chemical reactions, such as dissolution of soil minerals and salt precipitation. Mineral dissolution decreases and salt precipitation increases with reduction in the leaching fraction. Under steady-state conditions, the amount of salt leached in drainage water may be greater than, equal to, or less than the amount of salt added from the irrigation water.

Chemical reactions also take place between the cations on the exchange complex on the soil and those in solution. Since the salt concentration in the soil solution increases with depth, there is a corresponding increase in the *Sodium Adsorption Ratio (SAR)* of the soil solution in the same direction. The Exchangeable Sodium Percentage (ESP) also increases in the lower part of the root zone and may attain levels detrimental to soil structure. Excessive levels of sodium in the soil solution may be toxic to plant growth. Chemicals such as gypsum can be used to counteract these effects.

4.2.3 Irrigation Methods In Relation To Salinity Control

The usability of poor quality water for irrigation is conditioned to a great extent by the irrigation method employed.

Surface Irrigation

Efficient surface irrigation depends on an even distribution of water. Salinity control procedures include careful land levelling and controlled water application to ensure adequate and rapid watering of the border strip, basin or furrow with a minimum runoff. Inadequate salinity control is mostly due to inherent variability of intake rate and unsatisfactory land levelling. High spots or areas of low intake rates receive inadequate water, whereas excess leaching occurs in areas of high soil permeability or at low spots. The application of additional water to ensure adequate watering everywhere can result in an excessively high water table.





Artificial drainage is often required to control water table levels. The water table should be sufficiently low to prevent the rise of ground water into the root zone. The desirable water table level is dependant on the unsaturated conductivity of the soils. A relatively high water table (100cm) can be tolerated in coarse textured soils. A water table depth of about 180cm is generally recommended for soils of medium texture. A lower table is required for perennial crops than for annuals.

Inadequate watering and salinisation may occur on fine-textured soils because of insufficient infiltration rates. This is particularly true of crops of high water requirements. If soil permeability is insufficient to meet the leaching requirement a crop with lower water requirement or salt tolerance should be grown. Another possibility is to grow crops with high water requirements in rotation with crops with lower water requirements.

Furrow irrigation is commonly used for row crops. Since salts accumulate at the wetting front as water advances through the soil, salts tend to accumulate between the furrows.

Planting location on the ridge should be governed by the pattern of salt accumulation. The sloping bed system prevents salt accumulation at the location of seed placement. Rain during the growing season may cause damage by leaching salt into the root zone. The risk of damage can be greatly reduced by immediate irrigation. The salts which accumulate in the ridges during the cropping season will tend to become mixed through the surface soil when the field is prepared for the next season. The initial irrigation of the next crop will often provide adequate leaching for seed germination.

Sprinkler Irrigation

Sprinkler irrigation is becoming increasingly popular for a number of reasons. In countries with limited supply, water can be saved because with sprinkler irrigation higher efficiencies are easier to obtain than with flood irrigation. Land levelling is not necessary, and the need for artificial drainage is reduced – often natural drainage is sufficient.

Sprinkler irrigation provides an effective means of reducing the salt concentration on the surface, it is therefore increasingly used to start salt-sensitive row crops. Furrow irrigation can then be used for the remainder of the growing season.

For irrigation of woody species, special low angle sprinkler heads can be used to minimise leaf burn due to wetting of the foliage.

Trickle Irrigation

In this method water is applied at low rates through emitters located near the base of the plant. Water deficits resulting from evapotranspiration can be replaced on a daily basis. Trickle irrigation has been successfully used with highly saline waters. With this method high levels of salinity can be tolerated by plants than with other irrigation methods. It is believed that the increased tolerance is due to the steady supply of irrigation water which results in low salinity and high water content of the emitters. Under these conditions the uptake weighted mean salinity of the root zone is relatively constant and for a leaching fraction of 0,1 to 2,5 times that of the irrigation water. Under flood irrigation the uptake weighted mean salinity fluctuates from a minimum which about equal to the salinity of the irrigation water to ten times this value prior to the next water application.

With trickle irrigation zones of high salt concentration develop at the wetting front during the growing season and may have to be leached before a new crop is planted, except when row crops are planted in the old row location.





4.2.4 Properties of Irrigation Water

The quality of irrigation water is determined by:

pH

The pH of irrigation water should fall within 5,3 and 7,2.

Salinity

- The effect of salt on crop growth is osmotic and related to total salt concentration. On average salinity should be <250mS/m.

Sodicity

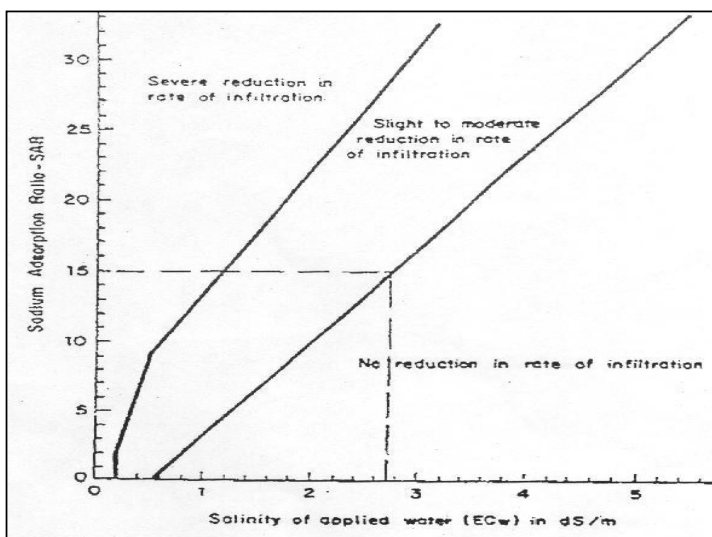

Figure 9: SAR relative to EC

- The sodium adsorption ratio (SAR) of the effluent should be maintained below 15 and electrical conductivity (EC) should be <250mS/m.

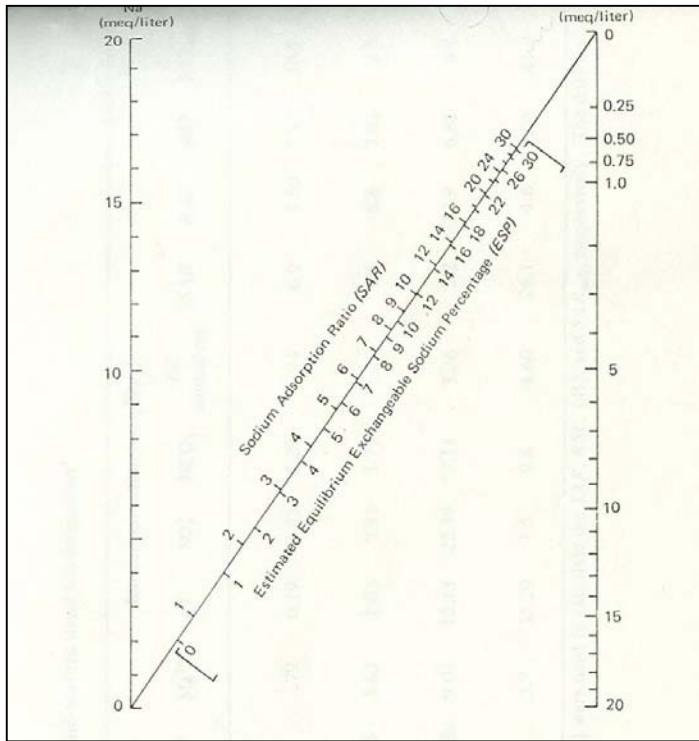

Figure 10: SAR relative to ESP

- If the SAR is maintained <15 the resulting ESP (exchangeable sodium percentage 1 N NH₄-Ac pH7) is also <15.

Bicarbonate and carbonate ions

- The principle cations and anions in irrigation water are calcium, magnesium, sodium, bicarbonate, sulphate, chloride and nitrate. If the pH exceeds 8,3 carbonate concentrations can become significant. Potassium concentrations are usually less than 1meq/l.

Trace elements

- Some soluble trace elements may have an inhibitory effect on plant growth. Elements in this category include boron, lithium, selenium and some heavy metals. The effluent water should be constantly be analysed for contamination anomalies.

5.0 CONCLUSIONS

- The dominant soils on the Buhuka Flats study area according to the FAO Soil Classification System include *Ferrasols*, *Litosols*, *Gleysols* and *Vertisols*.
- The *Ferrasols* is most suitable for the irrigation of 45m³/day sewage effluent.
- CNOOC would not want to irrigate far away due to pumping and piping costs. Irrigation would essentially have to be in close proximity to the permanent accommodation area. *i.e.* the *Ferrasols* occur near the CPF.
- A 3 to 5ha area in close proximity to the CPF would enable enough even distribution and rotation of 45m³/day sewage effluent to maintain plant available water between 33 – 1,500kPa.





- An indigenous pasture should be identified that would be suitable and sustainable for 45m³/day sewage effluent irrigation purposes.
- The **45m³/day sewage effluent** should be carefully monitored to ensure:
 - pH 5,3 and 7,2 (no acid and/or alkaline anomalies).
 - EC<250mS/m.
 - SAR<15 – maintain SAR<10 to ensure buffercapacity.
 - Assess toxicity of trace elements for specific pasture species utilized for irrigation.
 - Prevent eutrophication in soil through excess nitrogen and phosphorus being irrigated.
 - No human and/or plant pathogens become an environmental risk.
- The **3 – 5ha Ferrasols** should be carefully monitored to ensure:
 - pH 5,3 and 7,2 (1:2.5 soil:water ratio) in soil solution.
 - EC<250mS/m (saturated water extract).
 - ESP<15 (1N NH₄-Ac extract pH7) – maintain ESP<10 to ensure buffercapacity.
 - Ca: 200 – 4,000mg/kg (1N NH₄-Ac extract pH7).
 - Mg: 50 – 500mg/kg (1N NH₄-Ac extract pH7).
 - K: 20 – 300mg/kg (1N NH₄-Ac extract pH7).
 - Ca:Mg (1,5 – 4,5), Mg:K (3 – 4) and Ca+Mg/K (10 – 20) (1N NH₄-Ac extract pH7).
 - NO₃: 10-20mg/kg (saturated water extract).
 - P: 10-15mg/kg (Bray 1 extract).
 - Heavy metals: <0.01mg/kg (saturated water extract).
 - SO₄, Cl, B, F: <0,1mg/kg (saturated water extract).
 - No human and/or plant pathogens become an environmental risk.
 - Infiltration capacity: 10-15mm/h @ bulk density 1,275kg/m₃ (no crust formation).
 - C:N Ratio: 1:10.
- It should be considered to compile a soil water balance with the chosen pasture species under the climatic condition of the Buhuka Flats to optimize irrigation scheduling.
- The 3 – 5ha Ferralsol soil system at 1,500kg/m³/300mm bulk density contains an estimated 13,500,000 to 22,500,000kg soil. The average CEC range between 5 – 15cmol+/kg (1N NH₄-Ac extract pH7), which is an enormous advantage in terms of buffercapacity to utilize for 45m³/day sewage effluent irrigation in combination with plant root uptake of nutrients. However, it must be stressed the system should be carefully monitored and maintained to prevent contamination. Soil remediation cost could be as high as \$800/m³ (\$12,000,000/15,000,000m³ soil @ BD1,500kg/m³/300mm) depending on the severity of remediation required (e.g. ESP>15% requires leaching Na with Ca), this excludes site establishment of earth moving equipment (if necessary).



This investigation was done on available information and subsequent interpretation of data to reveal the properties on site with the techniques described.

Author: Chris Viljeon
Soil specialist
M.Sc Soil Science, Uni. of Potchefstroom

Senior review: Brent Baxter
Senior EIA Consultant
Ph.D. (Botany), B.Sc Hons, B.Sc. Uni. Natal
Prof. Natural Scientist, Registered ESIA
Professional



September 2017

REPORT - VOLUME 4, STUDY 5

CNOOC UGANDA LIMITED

KINGFISHER OIL PROJECT, HOIMA DISTRICT, UGANDA - WASTE MANAGEMENT SPECIALIST ASSESSMENT

Submitted to:

The Executive Director National Environment Management Authority, NEMA House,
Plot 17/19/21 Jinja Road, P. O. Box 22255 Kampala, Uganda



Report Number: 1776816-315741-1

Distribution:

- 1 x electronic copy CNOOC Uganda Limited
- 1 x electronic copy NEMA
- 1 x electronic copy Eco & Partner
- 1 x electronic copy Golder





Table of Contents

1.0 INTRODUCTION	1
1.1 Background.....	1
1.2 Project Description.....	1
1.3 Context of the Report.....	1
1.4 Waste Study Objectives.....	2
2.0 TERMS OF REFERENCE.....	2
2.1 Approach and Methodology.....	2
2.1.1 Data Collection and Review.....	2
2.1.1.1 Desktop Review of Relevant Documentation.....	2
2.1.1.2 Interfacing with Ugandan Authorities and Sub-Consultants	3
2.1.1.3 International Standards and Best Practice Guidelines	3
2.1.1.4 Waste Inventory and Classification	3
2.1.2 Impact Assessment.....	4
2.1.3 Environmental and Social Management Plan	4
2.2 Legal Framework and Guidance	4
2.3 Ugandan Regulatory Framework.....	4
2.4 IFC Guidelines and Standards	4
2.5 CNOOC's Standards and Requirements.....	5
3.0 WASTE BASELINE IN THE LAKE ALBERT OIL FIELDS AREA	31
3.1 Waste Generation	31
3.1.1 Non-Hazardous Waste.....	31
3.1.1.1 Waste Quantification	31
3.1.1.2 Waste Characterisations	31
3.1.2 Hazardous Waste.....	33
3.1.2.1 Drill Cuttings	35
3.1.2.2 Drilling Fluids	35
3.1.2.3 Associated Hazardous Wastes	39
3.2 Waste Inventory during Phases of Project Development.....	40
3.3 Waste Management Facilities	41
3.3.1 Hazardous Waste Management Facilities	41
3.3.1.1 Hazardous Waste Transporters	41





3.3.1.2	Hazardous Waste Treatment/Disposal Facilities	42
3.3.1.2.1	Drilling Cuttings	43
3.3.1.2.2	Drilling Fluids	47
3.3.1.2.3	Associated Hazardous Wastes	51
4.0	WASTE INVENTORY FROM KDA PROJECT PHASES.....	54
4.1	Drilling Phase Wastes	54
4.2	Construction Phase Wastes	56
4.3	Operational Phase Wastes	57
4.4	Decommissioning Phase Wastes	60
5.0	WASTE MANAGEMENT FOR THE KDA PROJECT	60
5.1	The Waste Management Hierarchy.....	60
5.2	Best Practice Waste Management for the KDA Project.....	62
5.2.1	Non-Hazardous Waste Management	62
5.2.2	Hazardous Waste Management	63
6.0	IMPACT ASSESSMENT	72
6.1	Impact Assessment Rating and Methodology.....	72
6.1.1	Impact Classification	72
6.1.2	Type of Impact	72
6.1.3	Intensity	72
6.1.4	Sensitivity	73
6.1.5	Impact Severity	74
6.2	Impact Assessment of the CPF, Wells and Associated Infrastructure	75
6.2.1	Construction Phase Impacts	75
6.2.1.1	Excavations and Removal of Topsoil, Overburden and Vegetation	76
6.2.1.2	Domestic / Sanitary Waste Water Discharge	76
6.2.1.3	Accidental Chemical Spills	76
6.2.1.4	Associated Hazardous Waste Generation	77
6.2.1.5	Non-Hazardous Waste Generation	77
6.2.1.6	Well Drilling	77
6.2.1.7	Well Blow - Out	77
6.2.2	Operational Phase Impacts	78
6.2.2.1	Associated Hazardous Waste Generation	79
6.2.2.2	Non-Hazardous Waste Generation	79





6.2.2.3	Temporary Storage of Hazardous Waste.....	80
6.2.2.4	Temporary Storage of Non-Hazardous Waste.....	80
6.2.2.5	Unauthorised Disposal of Waste.....	80
6.2.2.6	Domestic / Sanitary Waste Water Discharge.....	80
6.2.2.7	Waste Production Water.....	81
6.2.2.8	Accidental Chemical Spills.....	81
6.2.2.9	Associated Infrastructure or Flowline Failure.....	81
6.2.2.10	Well Drilling Wastes.....	81
6.2.2.11	Well Blow-Out.....	82
6.2.3	Decommissioning Phase Impacts.....	82
6.2.3.1	Existing Industrial Structures.....	82
6.2.3.2	Hazardous and Non-Hazardous Waste Generation.....	83
6.2.3.3	Temporary Storage of Dismantled used Infrastructure Materials.....	83
6.2.3.4	Closure of any Onsite Waste Storage Areas.....	83
6.3	Impact Assessment of Export Pipeline.....	83
6.3.1	Construction Phase Impacts.....	83
6.3.1.1	Waste Rock.....	84
6.3.1.2	Domestic / Sanitary Waste Water Discharge.....	84
6.3.2	Operational Phase Impacts.....	84
6.3.2.1	Export Pipeline or Flowline Failure.....	84
6.3.3	Decommissioning Phase Impacts.....	85
7.0	RECOMMENDATIONS FOR MITIGATION/MANAGEMENT AND MONITORING MEASURES.....	85
7.1	Mitigation of Impacts at the CPF, Wells and Associated Infrastructure.....	85
7.1.1	Construction Phase.....	85
7.1.1.1	Excavations and Removal of Topsoil, Overburden and Vegetation.....	85
7.1.1.2	Domestic / Sanitary Waste Water Discharge.....	85
7.1.1.3	Accidental Chemical Spills.....	86
7.1.1.4	Hazardous and Non-Hazardous Waste Generation.....	86
7.1.1.5	Well Drilling.....	87
7.1.1.6	Well Blow-Out.....	87
7.1.2	Operational Phase.....	87
7.1.2.1	Hazardous Waste Generation.....	87
7.1.2.2	Non-Hazardous Waste Generation.....	88





7.1.2.3	Temporary Storage of Hazardous Waste.....	88
7.1.2.4	Temporary Storage of Non-Hazardous Waste.....	89
7.1.2.5	Unauthorised Disposal of Waste.....	89
7.1.2.6	Domestic / Sanitary Waste Water Discharge.....	90
7.1.2.7	Uncontrolled Waste Production Water.....	90
7.1.2.8	Accidental Chemical Spills.....	90
7.1.2.9	Associated Infrastructure or Flowline Failure.....	90
7.1.2.10	Well Drilling Wastes.....	91
7.1.2.11	Well Blow-Out.....	91
7.1.3	Decommissioning Phase.....	91
7.1.3.1	Removal of Existing Industrial Structures.....	91
7.1.3.2	Hazardous and Non-Hazardous Waste Generation.....	91
7.1.3.3	Storage of Dismantled used Infrastructure Materials.....	91
7.1.3.4	Closure of any Onsite Waste Storage Areas.....	92
7.2	Mitigation of Impacts at the Export Pipeline.....	92
7.2.1	Construction Phase.....	92
7.2.1.1	Waste Rock.....	92
7.2.1.2	Domestic / Sanitary Waste Water Discharge.....	92
7.2.2	Operational Phase.....	92
7.2.2.1	Export Pipeline or Flowline Failure.....	92
7.2.3	Decommissioning Phase.....	92
8.0	LIMITATIONS.....	92
9.0	CONCLUSION.....	93
10.0	REFERENCES.....	93

TABLES

Table 1: Summary of Relevant Ugandan Legislation.....	1
Table 2: Summary of Relevant IFC Guidelines and Standards.....	21
Table 3: Summary of CNOOCs Own Policies, Guidelines and Standards.....	30
Table 4: Waste Quantification of the Lake Albert Oil Fields Area (Ref. 30).....	31
Table 5: Summary of waste streams and constituent non-hazardous waste composition expected to be generated from the Lake Albert Oilfield Development (Ref. 30).....	31
Table 6: Expected Non-hazardous Solid Waste Composition (Ref. 30).....	32
Table 7: Hazardous Wastes at the Phases of Oil Field Development.....	33



Table 8: Functional Categories of Additives Sometimes Used in Water-Based Drilling Fluids (Ref. 29 Section 11)	36
Table 9: Classification of non-aqueous drilling fluids (Ref. 29, Section 14)	38
Table 10: Associated Hazardous Waste Inventory	39
Table 11: Estimated Quantities of Hazardous Waste	40
Table 12: Hazardous Waste Companies Surveyed	41
Table 13: Overview of Uganda Hazardous Waste Transporters	42
Table 14: Key Characteristics of the Existing Biodegradation Facility	45
Table 15: Key Characteristics of the Hazardous Waste Landfill Sites	46
Table 16: Key characteristics of the drilling fluids treatment facilities	48
Table 17: Comparison of treatment technologies (adapted from Malan, 2013)	48
Table 18: Treated Effluent Discharges in comparison to the River Discharge Standards (adapted from Malan, 2013)	48
Table 19: Key Characteristics of the General Hazardous Waste Treatment Facilities	51
Table 20: Wastes generated on the KDA well pads during the drilling phase	55
Table 4: Expected Hazardous Solid Wastes generated during Construction of the CPF (34 months)	57
Table 21: Non-Hazardous waste from the CPF during the Operational Phase	58
Table 22: Hazardous production wastes generated at the CPF during the operational phase	59
Table 23: Best Available Technology for Non-Hazardous Waste Types	62
Table 24: International Industry BPEO and Currently Available BPEO in Uganda for O&G Wastes	63
Table 25: Hazardous Waste Management Options	66
Table 26: Types of Waste Impact	72
Table 27: Intensity Assessment Rating Scale	73
Table 28: Sensitivity Assessment Rating Scale	74
Table 29: Determination of Impact Severity	74
Table 30: Construction Phase Impact Assessment of CPF, Wells and Associated Infrastructure	75
Table 31: Operational Phase Impact Assessment of CPF, Wells and Associated Infrastructure	78
Table 32: Decommissioning Stage Impact Assessment of CPF, Wells and Associated Infrastructure	82
Table 33: Construction Phase Impact Assessment of the Export Pipeline	83
Table 34: Operational Phase Impact Assessment of the Export Pipeline	84
Table 35: Standards for Discharge of Effluent (Ref. 32)	85

FIGURES

Figure 1: Flow Chart of the Ugandan Regulatory Framework	5
Figure 2: Drilling Fluids Circulating System of a Drilling Rig and Well (Ref. 29)	36
Figure 3: Typical Composition (by weight percentage) of Water-Based Drilling Fluid (IOGP, 2016: 12)	37
Figure 4: Typical Composition (by weight percentage) of non-aqueous drilling fluids (Ref. 29, Section 12)	38





Figure 5: Examples of Modified Dump Truck (left), Vacuum Tanker (centre) and Box-body Truck (right)	42
Figure 6: Location of Existing Treatment/Disposal Hazardous Waste Facilities	43
Figure 7: Flowchart of the Biodegradation Process	44
Figure 8: One of the Open Cells at the Luwero Landfill Site.....	45
Figure 9: Minimum Engineering Design Requirements for Class A Landfill Site (South Africa, GN R. 636 norms and standards).....	47
Figure 10: Leachate Treatment Plant at EnviroServ	47
Figure 11: Flowchart of the Liquid Hazardous Waste Treatment Process	50
Figure 12: Multiple chamber Incinerator at Green Label's Facility (www.greenlabelservices.com).....	52
Figure 13: Dual-chamber Rotary Kiln under Construction at Luwero's Facility	53
Figure 14: Process for the Generation of Drilling Waste.....	54
Figure 15: Schedule of drilling of Producer and Injector wells	56
Figure 16: The Waste Management Hierarchy (Ref. 29).....	61
Figure 17: BPEO for Waste Collection, Transport and Treatment/Disposal.....	71

APPENDICES

APPENDIX A

Waste Inventory from CNOOC (August 2017)



ABBREVIATIONS AND ACRONYMS

ACGIH	by American Conference of Governmental Industrial Hygienists
BAT	Best Available Technology
BEI	Biological Exposure Indices
BOP	Blow-Out Preventer
BPEO	Best Practice Environmental Option
COD	Chemical Oxygen Demand
CNOOC	China National Offshore Oil Corporation
CPF	Central Processing Facility
C&D	Construction and Demolition
C&P	Construction and Production
DRC	Democratic Republic of Congo
EA	Exploration Areas
EH&S	Environmental, Health and Safety
ESP	Electrostatic Precipitators
ESIA	Environmental and Social Impact Assessment
ESMP	Environmental and Social Management Plan
EU	European Union
E&A	Exploration and Appraisal
E&P	Exploration and Production
GNR	Government Notice Regulation
GTL	Gas to Liquids
H:H	Hazardous
HSE	Health and Safety Environment
IFC	International Finance Corporation
KDA	Kingfisher Development Area
LNG	Liquefied Natural Gas
NADF	Non-Aqueous Drilling Fluid
NEMA	National Environment Management Authority
NIOSH	National Institute for Occupational Health and Safety
NORM	Naturally Occurring Radioactive Materials
OSHA	Occupational Safety and Health Administration
O&P	Oil and Gas





PAH	Poly-aromatic Hydrocarbon
PVC	Polyvinyl Chloride
PPE	Personal Protective Equipment
Ref.	Reference
RoW	Right of Way
SBM	Synthetic Based Mud
SCR	Selective Catalytic Reduction
SOP	Standard Operating Procedure
t/T	Tonnes
TDS	Total Dissolved Solids
TLV	Threshold Limit Value
UK	United Kingdom
US	United States
WBDF	Water Based Drilling Fluid
WBM	Water Based Mud
WWTP	Waste Water Treatment Plant
YR	Year



1.0 INTRODUCTION

1.1 Background

CNOOC Uganda Limited (CNOOC), Tullow Uganda Operations Pty Ltd (Tullow) and Total E&P Uganda Ltd (Total) are planning to develop oilfields within the Albertine Graben in western Uganda. The three companies have formed a partnership with equal interests in three government-designated exploration areas (EAs) or “Blocks”, with CNOOC operating in the Kingfisher Development Area (KDA) or EA3A, Tullow in Contract Area 2 and Total in Contract Area 1. The areas lie along the eastern border of Lake Albert, a 160 km-long, 35 km wide, natural lake forming the border between Uganda and the Democratic Republic of the Congo (DRC).

On the 16 September 2013, the first oil production licence in Uganda was awarded to CNOOC. The licence gave CNOOC the right to develop the KDA to full production. The Kingfisher oil field lies within the KDA, mostly beneath Lake Albert, in a 15 km by 3 km area.

1.2 Project Description

Details of the project location, process descriptions and proposed infrastructure are provided in the Environmental and Social Impact Assessment (ESIA) Project Description report.

The KDA comprises of five onshore well pads where all the development. The project will consist of the following components, located within two main areas:

- **The wells, flowlines, central processing facility (CPF) and supporting infrastructure.** These will be situated on the Buhuka Flats in the Kingfisher Development Area (KDA), along the south-eastern side of Lake Albert. The subsurface construction will include a total of 31 wells, made up of 20 production wells and 11 produced water injection wells. The CPF will also produce fuel gas, used to supply all of the project’s power requirements in the first 10 years, and LPG, which will be sold into the local market.
- **The export pipeline,** which will transport the stabilised crude oil from the CPF to Kabaale, roughly 52 km to the northeast, to tie in at the site of a proposed oil refinery, planned by the Ugandan Government.

1.3 Context of the Report

This report presents the Waste Management Specialist Assessment for the proposed KDA Project and has been undertaken by Golder Associates Africa (Pty) Ltd (Golder) as part of the CNOOC ESIA.

This report provides the waste assessment for the proposed Project addressed in the following sections:

- Section 1: Introduction;
- Section 2: Terms of Reference;
- Section 3: Waste Baseline for the Lake Albert Oil Fields Area;
- Section 4: Waste Inventory for the KDA Project;
- Section 5: Waste Management for the KDA Project;
- Section 6: Impact Assessment;
- Section 7: Recommendations for mitigation/management and monitoring measures;
- Section 8: Limitations;
- Section 9: Conclusions; and
- Section 10: References





1.4 Waste Study Objectives

This assessment considers the potential waste impacts arising from the proposed CNOOC project (the Project) in the KDA on the shore of Lake Albert, Uganda. Waste impacts are considered in the context of appropriate guidelines and with reference to information provided by CNOOC in the study area.

In order to assess the waste impacts associated with the Project, multiple stages of its development have been considered. Where significant waste impacts have been identified, mitigation has been considered and specified in order to reduce the significance of predicted impacts.

The primary objectives of the waste assessment are as follows:

- To identify waste related legislation or frameworks from Uganda applicable to the project, as well as IFC and international best practice standards in the O&G field and waste management;
- To identify all potential waste streams associated with the project and compilation of a waste inventory, with, as far as possible, the chemical characteristics of each waste stream;
- To evaluate the identified impacts associated with the different waste streams in terms of their probability of occurring, duration, scale and magnitude of impact in order to determine the overall significance during the project phases from construction to decommissioning;
- To recommend mitigatory measures for each impact, where possible, or recommend additional investigations for those impacts where mitigation cannot be identified currently; and
- To incorporate the waste management mitigation measures into the overall Environmental and Social Management Plan (ESMP) for the project.

2.0 TERMS OF REFERENCE

2.1 Approach and Methodology

The methodology that was employed during this Study is outlined in the subsections below including:

- Data Collection and Review;
- Impact Assessment; and
- ESMP.

2.1.1 Data Collection and Review

Data for the project were collected from various sources discussed as discussed hereunder.

2.1.1.1 Desktop Review of Relevant Documentation

Data for this assessment was primarily collected from available legal sources, similar O&G projects known to Golder, information provided by the local sub-consultants, the three O&G companies operating in the Lake Albert region, and other relevant source material. The following main documents were reviewed in order to obtain further data on the waste management situation, and also to gain an understanding of the scope and context of the proposed KDA project:

- Legal Framework
 - Ugandan guidelines and legislation;
 - IFC Standards and other relevant documentation;
 - International Best Practice documents; and
 - CNOOC Waste Specifications and Policies.
- Waste Inventory and Waste Management





- Waste Inventory for KDA based on estimations provided by CNOOC;
- Hazardous Waste Study undertaken by Golder end 2016 to early 2017;
- Non-hazardous waste study undertaken by Atacama in mid-2017; and
- Final Scoping Report with the ESIA Project Description undertaken by Golder in mid-2017.

2.1.1.2 *Interfacing with Ugandan Authorities and Sub-Consultants*

In order to obtain a thorough understanding of waste management legislation, practices and issues in Uganda, the specialist waste team interacted with Eco Partners to obtain information about the Ugandan authorities, legislation and regulatory studies, private waste management companies and other waste management role-players. Information gleaned from Golder and Eco Partners formed part of the Hazardous Waste Study (undertaken through separate contract study in 2017) and is extracted where relevant in this report. The objectives of those consultations were as follows:

- To obtain a firm understanding of Ugandan legislative requirements;
- To obtain technical and procedural requirements for waste management such as landfill design, transport requirements, classification systems, etc., and
- To obtain an understanding of waste recycling and re-use opportunities, treatment and disposal facilities in the country.

2.1.1.3 *International Standards and Best Practice Guidelines*

In addition to obtaining a firm understanding of the Uganda regulatory requirements, the existing waste management framework and waste management practices, cognisance was given to the requirements of the IFC Sustainability Performance Standards and other international best practices in the O&G and waste management sector.

The above was used to develop a framework for managing waste at the KDA project facilities in order to ensure sustainability, and a Duty of Care which includes protection of human health and the environment.

2.1.1.4 *Waste Inventory and Classification*

Once an understanding was obtained from the regulatory requirements, the IFC's Social and Environmental Sustainability Performance Standards, best practice standards and guidelines, relevant General EH&S Guidelines and the applicable Industry Sector Guidelines, an inventory is developed providing the annual waste quantities expected to be generated with the hazardous class and best practice management options for the wastes at the proposed KDA.

The waste inventory considers the following:

- Providing baseline, background information pertaining to waste generation;
- Identifying the location(s) where wastes may be generated, storage, handled, treated and/or disposed;
- Identifying the proposed quantity and type of potential wastes generated at the KDA during construction, operation and decommissioning; and
- Classifying the above wastes as general or hazardous, in terms of Ugandan guidelines, IFC EHS Guidelines and international best practice.

APPENDIX A provides the waste inventory summary as provided by CNOOC (email correspondence on 17 August 2017). However, some waste quantities, hazardous ratings and proposed waste management options were not provided. This may be due to the inventory being an anticipated / expected waste inventory with hazardous contaminant concentrations unknown at this stage of the project development to determine the hazardous rating. However, based on Golder's understanding of the proposed KDA and past studies in



the O&G industry, general categorisation of suitable waste management options and best practice environmental and technical options have been provided in this report.

2.1.2 Impact Assessment

Once a firm understanding had been gained of each waste type and its proposed management, an impact assessment was undertaken. The impact assessment took cognisance of the following:

- The site specific conditions;
- Regulatory, IFC and other waste management requirements;
- Best practice guidelines; and
- Waste characteristics.

Each waste type and the most suitable treatment and/or disposal site were assessed in terms of:

- Risks posed to the environment and human health and safety in order to identify the potential impacts. The significance of the potential impacts was established by considering the probability of occurring, duration of occurrence, scale and magnitude of impact;
- Based on the above, the significance of each identified impact; and
- Once the potential impacts have been assessed and their significance had been established, mitigatory measures were developed. In the development of mitigatory measures, cognisance was taken of the relevance and use of the waste management hierarchy, which entails, waste avoidance, waste minimisation, re-use and recycling, waste treatment and lastly disposal.

The cumulative impact was also considered, for instance the impact of waste water and waste disposal sites on the groundwater regime or on surface water bodies in the area.

2.1.3 Environmental and Social Management Plan

Once the impact assessment phase is completed, an Environmental and Social Management Plan (ESMP) was developed to give effect to the recommended mitigation measures for the management of waste generated at the Project areas. The waste ESMP is integrated with the other specialist plans, and recommendations (particularly the Surface Waste and Soil Specialist Study reports) into the ESMP for the project.

2.2 Legal Framework and Guidance

2.3 Ugandan Regulatory Framework

The following section presents a broad review of the Ugandan regulatory framework governing the collection, transportation, storage and treatment/disposal of hazardous waste from the O&G sector, both current and in draft form, as well as the relevant IFC Guidelines and Standards, and CNOOC's own requirements.

Figure 1 below presents a flow chart of the relevant Ugandan acts, regulations and standards. Regulation or standards shown in light blue are still in draft form, while those shown in dark blue are referred to in the legislation that still need to be developed.

Table 1 below presents a broad overview of some relevant Ugandan acts, regulations and standards governing the collection, transport, treatment and disposal of hazardous waste from the O&G sector. It is noted that Uganda is a signatory to the Basel Convention.

2.4 IFC Guidelines and Standards

Table 2 below presents a broad overview of IFC Guidelines and Standards that may be applicable to the collection, transport, treatment and disposal of hazardous waste from the Ugandan O&G sector.



2.5 CNOOC's Standards and Requirements

Table 3 below presents a broad overview of CNOOC's own Waste Management Specification standard that is applicable to the collection, transport, treatment and disposal of hazardous waste from the O&G sector.

Furthermore, CNOOC have their own Health and Safety Environment (HSE) Handbook requirements, which all suppliers are expected to comply with.

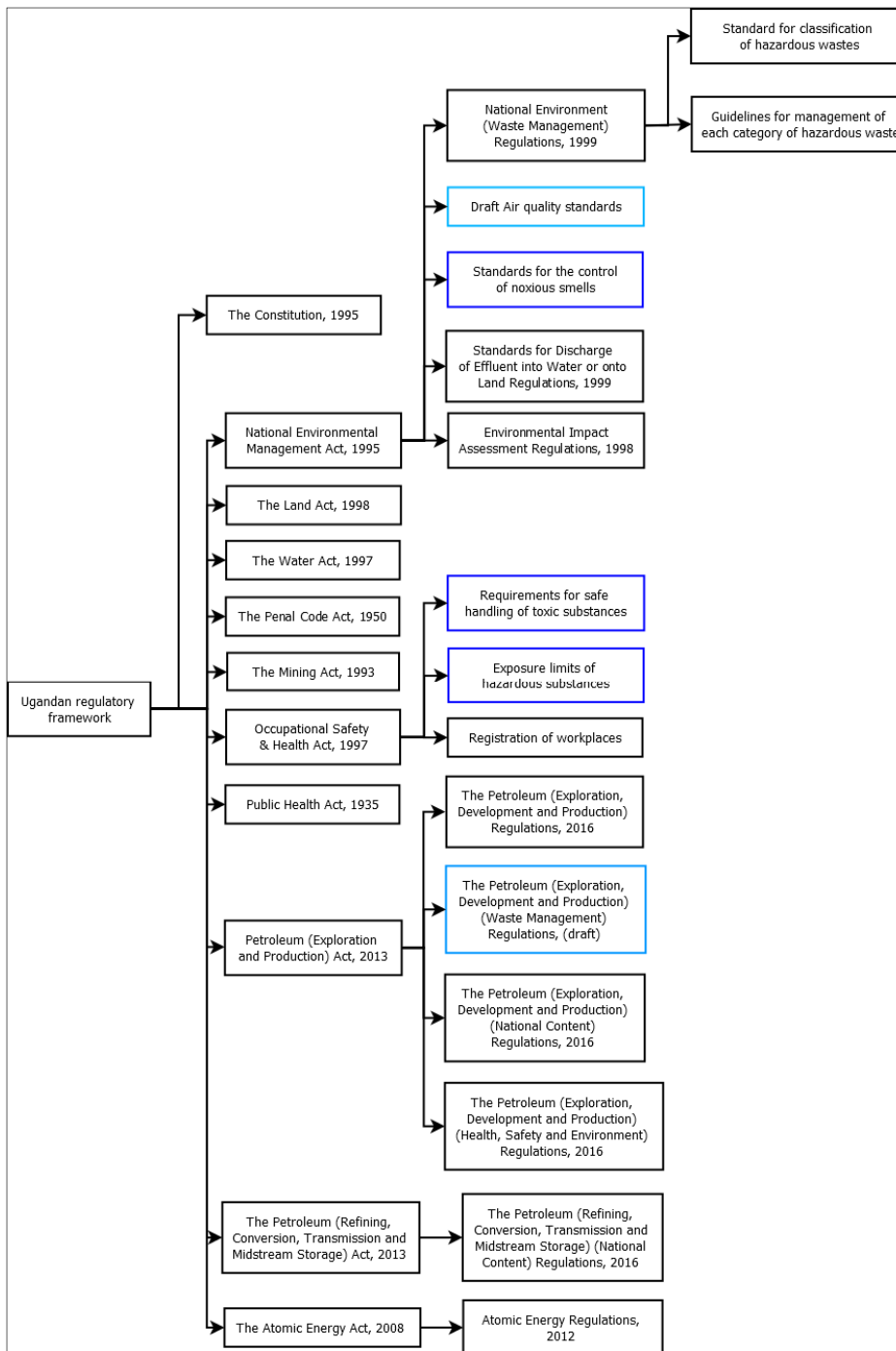

Figure 1: Flow Chart of the Ugandan Regulatory Framework





WASTE MANAGEMENT SPECIALIST ASSESSMENT

Table 1: Summary of Relevant Ugandan Legislation

Name	Year ratified	Relevant sections	Description
National Environment Management Act (Ref.4)	1995	52	Each person has a duty to manage and minimise any waste generated in such a manner that does not cause ill health to the person or damage to the environment, and in accordance with this Act. Any person who contravenes any provision of this Act commits an offence.
		53	Authority to establish a standard for the classification of hazardous wastes, and guidelines for the management of each category of hazardous waste. Any person who discharges any waste classified as hazardous without a licence or contrary to the said regulations commits an offence.
		56	No person is to discharge any hazardous substance, chemical, oil or mixture containing oil in any waters or any segment of the environment except in accordance with guidelines prescribed by the Authority. Any person who discharges a hazardous substance, chemical, oil or mixture containing oil in any waters contrary to these guidelines commits an offence. Upon conviction, the person may in addition to any other sentence, pay the cost of removal, including restoration, reparation, restitution, or compensation costs. The person shall mitigate the impact of the discharge by giving immediate notice to the authority, immediately beginning clean-up operations, and complying with directions the authority prescribes. Where the person fails to take the necessary measures, the Authority may seize the facility, vehicle or vessel, and after a reasonable time dispose of these to recover the costs of taking the necessary measures.
		57	No person shall pollute or lead any other person to pollute the environment contrary to any of the standards or guidelines of this Act.
		77	Any person who carries on activity which has or is likely to have a significant impact on the environment shall keep records relating to the amount of waste and by-products generated by the activity.
		97	Any person who fails to keep records of the activities, products, by-products and wastes required to be kept by this Act; or fraudulently alters any record required by this Act, commits an offence.
		98	Any person who contravenes any environmental standard or measure prescribed in this Act commits an offence.
		99	Any person who fails to manage any hazardous waste, disposes of any chemical or hazardous waste contrary to this Act, withholds information about the management of wastes, or aids or abets the illegal traffic in wastes is committing an offence.





WASTE MANAGEMENT SPECIALIST ASSESSMENT

Name	Year ratified	Relevant sections	Description
		Third Schedule	Projects to be considered for environmental impact assessment includes sites for hazardous waste disposal.
Petroleum (Exploration, Development and Production) Act (Ref. 11)	2013	3	<p>A licensee shall ensure that the management of production, transportation, storage, treatment and disposal of waste arising out of petroleum activities is carried out in accordance with environmental principles and safeguards prescribed under the National Environment Management Act and other applicable laws.</p> <p>The licensee shall contract a separate entity to manage the transportation, storage, treatment or disposal of waste arising out of petroleum activities.</p> <p>The licensee shall remain responsible for the activities of the entity managing the transportation, storage, treatment or disposal of their waste.</p> <p>The relevant authorities may grant a licence for the management, transportation, storage, treatment or disposal of waste arising out of petroleum activities to an entity contracted by a licensee on terms and conditions prescribed in the licence.</p> <p>A person contracted by the licensee to handle their waste shall not carry out those activities without a licence issued by the relevant authorities. To do so without a licence or failing to comply with the conditions of the licence is committing an offence.</p> <p>The relevant authorities shall make regulations for the management of the production, transportation, storage, treatment and disposal of waste arising out of petroleum activities.</p>
		88	<p>The licensee shall take all reasonable steps necessary to secure the safety, health, environment and welfare of personnel engaged in petroleum activities in the licence area including:</p> <ul style="list-style-type: none"> ■ Preventing the escape of any mixture of water or drilling fluid, and petroleum or any other matter; ■ Preventing the pollution of any water well, spring, stream, river, lake or reservoir by the escape of petroleum, water, drilling fluid, chemical additive, gas not being petroleum or any other waste product or effluent; and ■ Where pollution occurs, treating or dispersing it in an environmentally acceptable manner.
The Petroleum (Refining, Conversion, Transmission and Midstream Storage) Act (Ref. 12)	2013	3	<p>A licensee shall ensure that the management of production, transportation, storage, treatment and disposal of waste arising out of petroleum activities is carried out in accordance with environmental principles and safeguards prescribed by the National Environment Management Act and other laws.</p> <p>The licensee shall contract a separate entity to manage the transportation, storage, treatment or disposal of waste arising out of petroleum activities.</p> <p>The licensee shall remain responsible for the activities of the entity managing the transportation, storage, treatment or disposal of their waste.</p>





WASTE MANAGEMENT SPECIALIST ASSESSMENT

Name	Year ratified	Relevant sections	Description
			<p>The relevant authorities may grant a licence for the management, transportation, storage, treatment or disposal of waste arising out of petroleum activities to an entity contracted by a licensee on terms and conditions prescribed in the licence.</p> <p>A person contracted by the licensee to handle their waste shall not carry out those activities without a licence issued by the relevant authorities. To do so without a licence or failing to comply with the conditions of the licence is committing an offence.</p> <p>The relevant authorities shall make regulations for the management of the production, transportation, storage, treatment and disposal of waste arising out of petroleum activities.</p>
		26	<p>The licensee shall take all reasonable steps necessary to secure the safety, health, environment and welfare of personnel engaged in petroleum activities in the licence area including:</p> <ul style="list-style-type: none"> ■ Preventing the escape of any mixture of water or drilling fluid, and petroleum or any other matter; ■ Preventing the pollution of any water well, spring, stream, river, lake or reservoir by the escape of petroleum, water, drilling fluid, chemical additive, gas not being petroleum or any other waste product or effluent; and ■ Treating or dispersing it in an environmentally acceptable manner, where pollution occurs.
National Environment (Waste Management) Regulations (Ref. 15)	1999	3	<p>These Regulations apply -</p> <ol style="list-style-type: none"> a) to all categories of hazardous and non-hazardous waste; b) to the storage and disposal of hazardous waste and their movement into and out of Uganda; and c) to all waste disposal facilities, landfills, sanitary fills and incinerators.
		5	<p>A person who owns or controls a facility or premises which generate waste shall minimise the waste generated by adopting the following cleaner production methods.</p>
		6	<p>Application for licence for transportation of or storage of waste:</p> <ol style="list-style-type: none"> 1) A person intending to transport waste shall apply to the Authority for a licence in Form set out in the First Schedule. 2) A person intending to store waste on his or her premises shall apply to the Authority for a licence in Form III set out in the First Schedule. 3) An application under this regulation shall be accompanied by the appropriate fee prescribed in the Sixth Schedule. 4) A person intending to move waste from one district for disposal or storage in another district, shall, before applying for a licence under this regulation, notify, in writing, the District Environment Officers





WASTE MANAGEMENT SPECIALIST ASSESSMENT

Name	Year ratified	Relevant sections	Description
			<p>of the district from which he or she intends to move the waste and the district to which he or she intends to move the waste.</p> <p>5) A person who transports waste or stores waste on his or her premises without a licence issued under these Regulations commits an offence.</p>
		7	<p>Licence for transportation or storage of waste:</p> <p>1) The Authority may issue a licence for transportation of waste or for storage of waste under this regulation where (all the requirements of these Regulations have been met).</p> <p>2) A person granted a licence to transport waste shall ensure that it (meets the requirements of these regulations).</p> <p>3) A person licenced to transport or store waste shall ensure that all employees involved in the collection, transportation or storage of waste undergo such medical check-up as may be commensurate with the risks faced by the employees and, on completion of the check-up, the licensee shall submit a medical report of fitness in respect of each employee to the Authority.</p> <p>4) An environmental inspector may, at any time, subject the persons involved in the collection, transportation or storage of waste to a medical check-up and the costs of the examination shall be borne by the licensee.</p> <p>5) The vehicles used for transportation, or other means of conveyance, and the premises or storage of wastes shall be labelled in such a manner as may be directed by the Authority.</p> <p>6) The Authority may impose any conditions on a licence issued under this regulation which it may consider relevant to the transportation and storage of wastes.</p>
		8	<p>Duration and form of licence:</p> <p>1) A licence for the transportation or storage of waste is valid for one year and may be renewed by the Authority on the application of the licensee.</p> <p>2) The Authority may, where it deems it necessary, limit the validity of the licence to a specific number of transactions.</p> <p>3) A licence for the transportation of waste shall be in Form II set out in the First Schedule.</p> <p>4) A licence for the storage of waste shall be in Form IV set out in the First Schedule.</p> <p>5) A licence under this Regulation shall be accompanied by the appropriate fee prescribed in the Sixth Schedule.</p>
		10	<p>Packaging of waste:</p>



WASTE MANAGEMENT SPECIALIST ASSESSMENT

Name	Year ratified	Relevant sections	Description
			<ol style="list-style-type: none"> 1) Upon application for a licence for storage of waste under Regulation 6, the applicant shall provide a sample of the containers or packaging material in which the waste is to be stored. 2) The container or packaging material referred to in sub-regulation (1) shall be suitable for the storage of the waste for which the licence is required and shall - <ol style="list-style-type: none"> a. not be reactive to the waste to be stored in it; b. be free from the possibility of leakage; and c. not cause harm to persons involved in handling the waste, the neighbouring community and the environment in general. 3) Every container or package used for the storage of hazardous waste shall be labelled in accordance with Regulation 11 and shall be disposed of in the manner prescribed by Regulation 16. 4) A person who sells or offers for sale a container which has been used for the storage of hazardous waste to be used for a purpose other than the storage of waste commits an offence.
		11	Labelling: <ol style="list-style-type: none"> 1) Each container or package of hazardous waste shall have attached to it a label, in easily legible characters, written in English and any other relevant local languages. 2) A label shall, at a minimum, contain the following information (listed in these Regulations). 3) A vehicle or other conveyance carrying hazardous wastes shall be labelled in accordance with sub-regulation 2(f) and the label shall not contain any warranties, guarantees or liability exclusion clauses inconsistent with this Statute or these Regulations.
		14	Licence to own or operate a waste treatment plant or disposal site: <ol style="list-style-type: none"> 1) The Technical Committee shall issue to an applicant a licence to own or operate a waste treatment plant or waste disposal site (if it meets the requirements of these Regulations). 2) A licence to own or operate a waste disposal site or plant shall be in Form VI set out in the First Schedule and shall be accompanied by the appropriate fee prescribed in the Sixth Schedule. 3) A person licenced to own or operate a waste treatment plant or disposal site shall ensure that it (has met all the requirements of these Regulations). 4) The Technical Committee may impose conditions on a licence for the operation of a waste treatment or disposal site as it considers necessary. 5) A licence to own or operate a waste treatment plant or disposal site is valid for one year and may be renewed: except that the Technical Committee may limit the duration of the licence for a period of less than one year, but not less than six months.





WASTE MANAGEMENT SPECIALIST ASSESSMENT

Name	Year ratified	Relevant sections	Description
			<p>6) The Authority may, where it deems it necessary, issue a licence to an applicant under regulation 7 for the temporary storage of any waste pending final disposal of the waste: and the temporary storage shall meet the standards required for the disposal of that category of waste as required by these Regulations.</p> <p>7) A person who (a) operates or owns a waste disposal site without a licence or (b) discharges waste onto a site or plant which is unlicensed commits an offence.</p>
		15	<p>Environmental Impact Assessment:</p> <p>1) A waste treatment plant or disposal site shall not be licenced under these Regulations unless an environmental impact assessment has been carried out in accordance with Sections 19, 20 and 21 of the Act.</p> <p>2) An operator of a waste treatment plant or disposal site shall carry out an annual audit of the environmental performance of the site or plant and shall submit a report to the Authority.</p>
		16	<p>Disposal of waste:</p> <p>1) Where a disposer intends to dispose of or treat waste, the disposer shall, in addition to the matters required under Regulations 13 and 14, indicate in his or her application for a licence, the disposal operations he or she intends to carry out in accordance with the categories identified in the Fifth Schedule and shall enclose (the document requirements listed in the Regulations).</p> <p>2) In issuing a licence for the disposal of waste, the Authority shall clearly indicate the disposal operation permitted and identified for the particular waste in accordance with the Fourth Schedule.</p> <p>3) A person who disposes of waste in contravention of this regulation commits an offence.</p>
		17	<p>Prevention of pollution from treatment plant and disposal site:</p> <p>1) Every person who operates a waste treatment plant or disposal site shall take all necessary measures to prevent pollution from the site or plant, including the erection of necessary works and instituting of mitigation measures.</p> <p>2) In taking measures to prevent pollution under sub-regulation (1), the operations of a waste treatment plant or disposal site shall comply with any directions given by an environmental inspector under Section 81 of the Statute. In taking measures to prevent pollution under sub-regulation (1), the operations of a waste treatment plant or disposal site shall comply with any directions given by an environmental inspector under Section 81 of the Statute.</p>
		22	Insurance:



WASTE MANAGEMENT SPECIALIST ASSESSMENT

Name	Year ratified	Relevant sections	Description
			<ol style="list-style-type: none">1) An applicant for a licence under Regulations 6, 13 and 18 shall satisfy the Authority that he or she has subscribed to an insurance policy covering the risks likely to arise out of the activity for which the licence is required.2) A generator of waste which has been characterised as hazardous under the Fifth Schedule shall, upon written instructions from the Executive Director, subscribe to an insurance policy to cover risks caused by that waste.
		23	<p>Reporting procedures:</p> <ol style="list-style-type: none">1) A person licenced to carry out any activity under these Regulations shall submit bi-annual reports on the conduct of the licenced activity to the Authority.2) Where special reporting procedures are made the condition of a licence granted under these Regulations, those procedures shall take precedence over the submission of bi-annual reports under sub-regulation (1).
		24	<p>Duty to keep records:</p> <ol style="list-style-type: none">1) The holder of a licence under these Regulations shall keep a record of the licenced activity and all transactions related to it and submit the record to the Authority every six months from the commencement of the licenced activity.2) The Authority may order the licensee install metering devices at the expense of the licensee, and take samples and analyse them as the Authority may direct.
		26	<p>Improvement notice:</p> <ol style="list-style-type: none">1) Where an environmental inspector has reasonable cause to believe that any person is violating these Regulations, he or she may issue against that person an improvement notice.
		27	<p>Cancellation of licence:</p> <ol style="list-style-type: none">1) The Authority may, on the advice of the Technical Committee, suspend or revoke a licence issued under these Regulations if it is satisfied that the conditions of the grant of the licence have not been complied with or the continued operation of the waste treatment plant or disposal site will be injurious to the health of the neighbouring community or to the environment in general.
		28	<p>Penalties:</p> <ol style="list-style-type: none">1) A person who commits an offence under these Regulations is liable, on conviction, to imprisonment for a term of not less than thirty six months or to a fine of not less than three hundred and sixty thousand shillings and not more than thirty six million shillings or both.



WASTE MANAGEMENT SPECIALIST ASSESSMENT

Name	Year ratified	Relevant sections	Description
		29	Fees: 1) The fees prescribed in the Sixth Schedule shall be paid for the various applications and licences under these Regulations.
National Environment (Standards for Discharge of Effluent into Water or on Land) Regulations (Ref. 17)	1999	3	The standards for effluent or waste water before it is discharged into water or on land is prescribed in the Schedule to these Regulations.
		4	Every industry or establishment shall install at its premises, anti-pollution equipment, for the treatment of effluent chemical discharge emanating from the industry or establishment. The equipment shall be based on the best practicable means environmentally sound practice or other guidelines determined by the authorities.
		5	The person must keep a record of the amount of waste generated and of the parameters of the discharges, and submit these records to the authorities every three months from the commencement of the activity for which the permit was issued.
		Schedule	Prescribes the standards for discharge of waste water.
The Environmental Impact Assessment Regulations (Ref. 18)	1998	3	These Regulations apply to all projects, including major repairs, extensions, or routine maintenance to an existing project which is included in the Third Schedule of the National Environment Act, 1995 (i.e. sites for hazardous waste disposal).
		5	A developer shall prepare a project brief stating the possible products and by-products, including waste generation of the project.
Petroleum (Exploration, Development and Production) Regulations (Ref. 19)	2016	42	The licensee shall, before drilling any well, submit to the relevant authority, a well proposal and drilling programme, which includes the methods to be adopted for the disposal of waste including spent mud, cuttings and camp waste, from the location of the well.
<i>Petroleum (Waste Management) Regulations (Ref. 20)</i>	<i>Draft form</i>	2	<i>These Regulations apply to a person involved in-</i> <i>a) the production, transportation, storage, treatment or disposal of waste arising out of petroleum activities or midstream operations; and</i> <i>b) the construction and operation of petroleum waste management facilities.</i>





WASTE MANAGEMENT SPECIALIST ASSESSMENT

Name	Year ratified	Relevant sections	Description
			<p><i>In addition, a person must also with the National Environment Act, the Petroleum (Exploration, Development and Production) Act, 2013, the Petroleum (Refining, Conversion, Transmission and Midstream Storage) Act, 2013, the National Environment (Waste Management) Regulations, the Occupational Safety and Health Act, 2006 and any other applicable law;</i></p> <p><i>Waste not classified as petroleum waste shall be managed in accordance with the National Environment (Waste Management) Regulations.</i></p>
		4	<p><i>The licensee and the petroleum waste handler shall apply the principles as set out in these Regulations to the management of petroleum waste.</i></p>
		5	<p><i>The licensee shall contract a separate entity to be licensed by the Authority in accordance with these Regulations as a petroleum waste handler to manage the transportation, storage, treatment or disposal of waste arising out of petroleum activities or midstream operations. The separate entity shall not include any affiliate or subsidiary of the licensee.</i></p> <p><i>The licensee shall remain responsible for the management of petroleum waste by the petroleum waste handler;</i></p> <p><i>The licensee shall remain liable for future pollution costs resulting from the petroleum waste managed under these Regulations; and</i></p> <p><i>The licensee shall provide a financial security, in the form of an on-demand bank guarantee to cover the cost of managing the licensee's petroleum waste by the petroleum waste handler in the event of non-compliance with the requirements of any applicable law or conditions of a licence, closure or bankruptcy.</i></p>
		6	<p><i>The licensee and the petroleum waste handler have a duty of care and shall take all reasonable and applicable measures:</i></p> <ul style="list-style-type: none"> <i>a) to ensure that petroleum waste is managed appropriately and securely;</i> <i>b) to ensure that any leakage or spillage of petroleum waste is quickly and reliably detected and handled; and</i> <i>c) ensure that spillages which may cause pollution are notified to the Authority and other relevant authorities.</i> <p><i>The petroleum waste handler shall, within a period of 30 days of grant of a licence under regulation 16, provide a financial security to cover the cost of decommissioning and restoration, including closure, monitoring and after-care for landfills in the event of non-compliance, closure or bankruptcy.</i></p>
		7	<p><i>The licensee and the petroleum waste handler shall manage waste through the application of hierarchical waste management practices:</i></p>



WASTE MANAGEMENT SPECIALIST ASSESSMENT

Name	Year ratified	Relevant sections	Description
			<i>When applying the waste management hierarchy, the licensee and petroleum waste handler shall take measures to encourage the options that deliver the least impact to the environment and human health.</i>
		8	<i>The licensee and the petroleum waste handler shall, where the production of intractable petroleum waste is not preventable and where there are no recycling, treatment or disposal options within Uganda, ensure that the waste is exported for proper disposal.</i>
		9	<p><i>The licensee and the petroleum waste handler shall:</i></p> <ul style="list-style-type: none"> <i>a) ensure that the different types of petroleum waste are segregated at source and at the petroleum waste management facility by way of waste stream and classification, to facilitate their appropriate handling and traceability;</i> <i>a) ensure that the classification of waste and the further handling and treatment of petroleum waste is not distorted by mixing or dilution of waste; and</i> <i>b) continuously improve the petroleum waste management practices as technology advances.</i>
		10	<p><i>The licensee and the petroleum waste handler shall establish, follow up and further develop a waste management system designed to ensure compliance with the requirements of these Regulations and any other applicable laws;</i></p> <p><i>The licensee and petroleum waste handler shall ensure that the personnel managing the petroleum waste understand and comply with the waste management system and waste management plans; and</i></p> <p><i>The waste management system and waste management plans shall be documented, implemented and regularly updated and made available to the Authority and other relevant lead agencies on request.</i></p>
		11	<p><i>The licensee shall identify all petroleum waste streams with respect to volumes and any significant risks that they may pose to human health and the environment.</i></p> <p><i>The waste streams identified shall be quantified, characterized and documented in order to develop the best petroleum waste management options.</i></p> <p><i>The licensee shall continuously evaluate the processes that generate petroleum waste streams in order to comply with these Regulations.</i></p>
		12	<p><i>A person or entity shall not manage petroleum waste without a licence issued by the Authority under these Regulations;</i></p> <p><i>An application for a licence to manage petroleum waste shall be made to the Authority in the form set out in these Regulations, and shall attach a copy of an environment impact assessment certificate or environmental risk certificate granted for the activity;</i></p>



WASTE MANAGEMENT SPECIALIST ASSESSMENT

Name	Year ratified	Relevant sections	Description
			<i>An application under this regulation shall be accompanied by the appropriate fee prescribed in these Regulations.</i>
		15	<i>An application for a licence to manage petroleum waste shall be processed expeditiously, but in any case not later than ninety days from the date of receipt of complete application.</i>
		16	<i>The Authority shall, before grant of a licence, require the applicant to submit to the Authority an insurance policy covering the environmental risks likely to arise out of the waste management activity for which the licence is required.</i>
		17	<i>The Authority may impose conditions in a licence issued under these Regulations which it may consider relevant for petroleum waste management.</i>
		18	<i>A licence for the transportation of petroleum waste shall be valid for a period of one year. A licence for the storage, treatment or disposal of petroleum waste shall be valid for a period of three years. Notwithstanding the above, the Authority may suspend or revoke a licence issued under these Regulations.</i>
		19	<i>The Authority may suspend or revoke the licence where:</i> <ul style="list-style-type: none"> <i>a) information or data given by the applicant in the application or during consultations was false, substantially incorrect or intended to mislead;</i> <i>b) information leading to approval of the application was hidden or concealed and gave rise to a wrong decision;</i> <i>c) the licence was issued in error;</i> <i>d) there is non-compliance with these Regulations or the conditions set out in the licence with the effect of undermining the integrity of the environment;</i> <i>e) it is necessary to protect human health or to prevent harm or further harm to the environment, a situation that was not foreseen during the process for grant of the licence;</i> <i>f) there is a substantial change or modification of the petroleum waste management activity for which the licence was granted, which may lead to adverse environmental impacts or endanger human health or safety; or</i> <i>g) there is a substantive undesirable effect not contemplated during the approval of the application for grant of the licence.</i>
		20	<i>A person who, before the commencement of these Regulations was carrying on the business of petroleum waste management shall apply to the Authority for a licence in accordance with these Regulations within</i>





WASTE MANAGEMENT SPECIALIST ASSESSMENT

Name	Year ratified	Relevant sections	Description
			<i>twelve months after the commencement of these Regulations or at the expiration of an existing licence, where the remaining licence period is less than twelve months.</i>
		21	<i>Where a licence is suspended or revoked, the petroleum waste handler shall stop any further operations and undertake any remedial activities required by the Authority.</i>
		22	<i>A person granted a licence under these Regulations may apply to the Authority for renewal of the licence within ninety days before the expiration of the licence.</i>
		23	<i>Where the petroleum waste handler wishes to transfer the licence, he or she shall notify the Authority within sixty days before the date of the intended transfer. Where the Authority is not satisfied that the proposed new owner or operator meets the requirements for the management of petroleum waste under these Regulations, the Authority may reject the transfer of the licence.</i>
		24	<i>The licensee and the petroleum waste handler shall classify and characterise petroleum waste streams in accordance with these Regulations; The licensee and petroleum waste handler shall use laboratories which are designated by the Authority or certified for provision of laboratory services for the characterization of petroleum waste; The licensee shall not hand over to a petroleum waste handler petroleum waste that is not classified and characterized in accordance with this regulation. The licensee and petroleum waste handler shall use the information on classification and characterisation of petroleum waste under this regulation together with the waste manifest to guide the subsequent management of the petroleum waste.</i>
		25	<i>The licensee shall provide the petroleum waste handler with a waste manifest in accordance with these Regulations; The licensee and petroleum waste handler shall each enter details in the relevant part of the waste manifest; The waste manifest shall be kept by the licensee and petroleum waste handler in hard copy and in electronic form for a period of at least five years from the date of first movement of the waste, thereafter the waste manifest shall be kept and be available in electronic form; The waste manifest shall be available to the Authority, environmental inspectors and other authorized officers on request; The petroleum waste handler shall not accept the petroleum waste that is not accompanied by a manifest; or does not match the description on the accompanying waste manifest;</i>





WASTE MANAGEMENT SPECIALIST ASSESSMENT

Name	Year ratified	Relevant sections	Description
			<i>Where any person attempts to transport or deliver petroleum waste to the petroleum waste management facility contrary to these Regulations, the petroleum waste handler shall reject the waste; immediately notify the licensee, the Authority and any other relevant government authority; and direct the transporter to return the waste to the licensee, unless otherwise instructed by the Authority.</i>
		26	<i>A petroleum waste handler shall not manage petroleum waste at a waste management facility without taking reasonable measures to identify all hazards associated with the petroleum waste; The petroleum waste handler shall inquire into and ascertain the composition of petroleum waste wherever the petroleum waste handler has reason to believe that a process or operation producing the petroleum waste delivered to the waste management facility has changed; or the description of a petroleum waste received at the facility does not match the description of the petroleum waste on the accompanying waste manifest;</i>
		27	<i>The licensee or petroleum waste handler shall not store or transport in the same container two or more types of petroleum wastes which are not compatible; or a petroleum waste which is not compatible with any substance placed in the container; The licensee or petroleum waste handler who uses a container to store or transport hazardous waste shall do so in accordance with these Regulations; and A person shall not place petroleum waste in an unwashed container that previously held a material which is incompatible with that petroleum waste; or use a container which contains residues of petroleum waste to store, hold or transport food, animal feed or a product which may directly or indirectly become part of food for human consumption.</i>
		28	<i>A container or package containing petroleum waste shall have attached to it a label in accordance with these Regulations, written in English in easily legible characters as determined by the Authority; The English label shall be permanently fixed to the package and may have a translation in a relevant local language; and All primary containers for petroleum waste containing hazardous chemicals and substances shall be packaged with up-to-date material safety data sheets with directions for handling of petroleum waste, including safety precautions.</i>
		29	<i>The licensee or petroleum waste handler shall ensure that vapours emitted during filling, cleaning or storage of petroleum waste containers or operation of petroleum waste management facilities do not expose a person to offensive odours at the vicinity of the waste handling facility; or cause the concentration of the vapours to exceed permissible levels of exposure.</i>





WASTE MANAGEMENT SPECIALIST ASSESSMENT

Name	Year ratified	Relevant sections	Description
		30	<p><i>The licensee may, with the approval of the Authority, store petroleum waste generated on-site for a period not exceeding three months to accumulate quantities of waste material that can be transported for recycling, treatment or disposal where the petroleum activity or midstream operation is undertaken intermittently;</i></p> <p><i>The quantities temporarily stored on site shall not exceed one thousand kilogrammes;</i></p> <p><i>Short-term storage shall be done in appropriate facilities in accordance with these Regulations;</i></p> <p><i>The licensee and the petroleum waste handler shall keep logs of the waste stored under this regulation.</i></p>
		31	<p><i>The licensee or petroleum waste handler shall designate and manage waste storage areas in accordance with these Regulations.</i></p> <p><i>The waste storage areas shall be indicated on the facility layout drawing of licensee or petroleum waste handler, including the storage capacity, petroleum waste types to be stored, and operating practices.</i></p> <p><i>Storage of petroleum waste shall be based on environment risk assessment performed in accordance with the National Environment Act.</i></p> <p><i>The licensee and the petroleum waste handler shall establish adequate measures to the satisfaction of the Authority for the security of storage facilities so that corrective measures can be taken in the event of accidents or leakages.</i></p> <p><i>Access to waste storage areas shall be controlled and documented to the extent to the extent that is necessary.</i></p>
		32	<p><i>The licensee and petroleum waste handler shall ensure that any petroleum waste containing radioactive materials is managed in accordance with the Atomic Energy Regulations, 2012;</i></p> <p><i>The licensee and the petroleum waste handler shall, in accordance with a permit or licence obtained from the Atomic Energy Council, regulate the use of radioactive materials, to prevent exposure or contamination and accumulation of petroleum waste containing radioactive material and to provide for safe dispose of the waste.</i></p> <p><i>The licensee shall be liable for any exposure of persons to petroleum waste containing radioactive material and related wastes in the licensee's control in a petroleum activity or midstream operation.</i></p>
		33	<p><i>A petroleum waste handler holding a licence to transport petroleum waste shall ensure that:</i></p> <ol style="list-style-type: none"> <i>a) the collection and transportation of waste is conducted in a manner that does not cause leakage, scattering or littering of the waste or the emitting of noxious smells or harmful odours;</i> <i>b) the vehicle or vessel used for transportation of petroleum waste is labelled with the words "HAZARDOUS WASTE" in permanent, fluorescent and legible characters determined by the Authority, and placed on either side of the vehicle or vessel in a colour contrasting with the background;</i>



WASTE MANAGEMENT SPECIALIST ASSESSMENT

Name	Year ratified	Relevant sections	Description
			<p>c) <i>the vehicles or vessels for transportation of petroleum waste and other means of conveyance of petroleum waste follow the approved scheduled routes from the point of collection to the disposal site or plant;</i></p> <p>d) <i>a waste manifest, and a material safety data sheet for waste containing hazardous chemicals, accompany the waste to enable the tracking of each batch of waste from its source to its final disposal; and</i></p> <p>e) <i>the personnel involved in the collection and transportation of petroleum waste are provided with:</i></p> <ul style="list-style-type: none"> <i>i) adequate protective and safety clothing;</i> <i>ii) adequate appropriate equipment or facilities for handling the waste;</i> <i>iii) safe and secure sitting facilities in the vehicles used for transporting waste; and</i> <i>iv) proper training, information and instructions, including on how to handle emergency situations.</i> <p><i>A petroleum waste handler shall not permit unauthorized access to the vehicle or vessel used for the transportation of the waste.</i></p>
		34	<p><i>The petroleum waste handler with a licence to transport petroleum waste shall put in place a journey management plan before commencement of operations for the transportation of petroleum waste and shall make it available to the Authority and lead agency on request;</i></p> <p><i>A copy of the journey management plan shall at all times be present in the vehicle or vessel transporting the petroleum waste;</i></p> <p><i>The petroleum waste handler shall install electronic tracking systems for vehicles used in the transportation of petroleum waste;</i></p> <p><i>The Authority and relevant lead agency may require the petroleum waste handler to provide the tracking information generated under this sub-regulation.</i></p>
		35	<p><i>The petroleum waste handler shall treat petroleum waste and petroleum contaminated soils in accordance with the treatment methods and environmental standards approved by the Authority;</i></p> <p><i>Where there are no environmental standards, the licensee and petroleum waste handler shall, with the approval of the Authority, use internationally recognised standards where available;</i></p> <p><i>The petroleum waste handler shall have quality control and quality assurance protocols to ensure that the treatment of petroleum waste and petroleum contaminated soils is in compliance with this regulation; and</i></p> <p><i>A person who contravenes this regulation commits an offence and is liable on conviction to a fine or imprisonment or both.</i></p>





WASTE MANAGEMENT SPECIALIST ASSESSMENT

Name	Year ratified	Relevant sections	Description
		36	<p><i>A person who wishes to utilise treated petroleum waste which is not classified or characterised as hazardous shall apply to the Authority;</i></p> <p><i>The Authority may, in consultation with the relevant lead agency, approve utilisation of treated petroleum waste; and</i></p> <p><i>The petroleum waste handler and the person utilising the treated petroleum waste u shall be responsible for any pollution or health impacts that may arise from the utilisation of treated petroleum waste.</i></p>
		37	<p><i>The petroleum waste handler may dispose of petroleum waste by methods approved by the Authority in consultation with the lead agency and subject to environment assessments carried out by the petroleum waste handler; and</i></p> <p><i>Where secondary waste is generated by any of the methods referred to in this sub-regulation, the petroleum waste handler shall ensure that the secondary waste is disposed of at designated waste sites licensed by the Authority.</i></p>
		38	<p><i>The petroleum waste handler with a licence to landfill petroleum waste, shall –</i></p> <ul style="list-style-type: none"> <i>a) construct an engineered landfill in accordance with environmental standards and guidelines;</i> <i>b) ensure that the engineered landfill is located in an area which has been identified after undertaking research and studies and found to be suitable for the purpose and has been subjected to environment assessment;</i> <i>c) provide an approved secure buffer zone surrounding the active area of the engineered landfill in accordance with environmental standards;</i> <i>d) apply appropriate and effective practices and techniques that prevent leakage of hazardous elements into the ground water systems and soil, so as to prevent the risk of environmental pollution; and</i> <i>e) conduct regular monitoring of air, water and soil quality in the surrounding environment to establish the levels of contaminants arising from the landfill operations and submit reports to the Authority on a half yearly basis.</i> <p><i>Where there are no environmental standards, the licensee and petroleum waste handler shall, with the approval of the Authority, use internationally recognised standards, where available.</i></p>
		39	<p><i>A petroleum waste handler with a licence to incinerate petroleum waste shall ensure that the incinerator is designed to ensure that its operation is in compliance with environmental standards; and is adopted to the specific type of petroleum waste to be incinerated.</i></p> <p><i>Where there are no environmental standards, the licensee and petroleum waste handler shall, with the approval of the Authority, use internationally recognised standards where available.</i></p>



WASTE MANAGEMENT SPECIALIST ASSESSMENT

Name	Year ratified	Relevant sections	Description
			<i>A petroleum waste handler shall ensure that any residual material arising from the incineration process under this regulation is handled in accordance with the National Environment (Waste Management) Regulations.</i>
		40	<i>A person shall not establish, construct or operate any petroleum waste management facility within the buffer zone distances as set out these Regulations; A petroleum waste management facility shall maintain buffer zone distances as permitted by the Authority in accordance with these Regulations.</i>
		41	<i>The licensee and the petroleum waste handler shall ensure that the petroleum waste treatment or disposal methods do not cause adverse effects to human health or on the environment through emissions, discharges, emissions or other contamination.</i>
		42	<i>The licensee and the petroleum waste handler shall ensure that they have emergency response plans that sufficiently addresses emergencies relating to petroleum waste management in place; and their employees are provided with instructions on how to handle emergency situations and are regularly trained in handling the situations in accordance with the instructions.</i>
		43	<i>A petroleum waste handler shall put in place and maintain at a petroleum waste management facility appropriate warning and safety systems; and measures to prevent fire or explosions, or uncontrolled releases of hazardous substances or damage to the structural integrity of the petroleum waste management facility.</i>
		44	<i>The petroleum waste handler shall prepare and submit to the Authority for approval a comprehensive decommissioning plan for the waste management facility at least twenty four months prior to the commencement of the decommissioning. The decommissioning process shall be undertaken in accordance with the approved decommissioning plan and relevant environmental standards and international best practice. Where there are no environmental standards, the decommissioning shall be undertaken in accordance with internationally recognised standards, where available. On completion of the decommissioning, the petroleum waste handler shall submit a report stating the end of the decommissioning process, achievements and issues for follow up.</i>
		45	<i>A petroleum waste handler shall handle all remaining petroleum waste and other waste produced during decommissioning in accordance with these Regulations and the National Environment (Waste Management) Regulations.</i>



WASTE MANAGEMENT SPECIALIST ASSESSMENT

Name	Year ratified	Relevant sections	Description
		46	<p><i>A Petroleum waste handler shall in respect of the petroleum waste handled and in accordance with these Regulations, maintain at the waste management facility an operating record or inventory record; and an inspection record, including information from the waste manifest.</i></p> <p><i>The licensee and petroleum waste handler shall by the 31st of January of each year, submit to the Authority an annual report.</i></p> <p><i>Where the petroleum waste handler has decommissioned a petroleum waste management facility he or she shall, for such a period as is determined by the Authority, submit to the Authority an annual report on the condition of the decommissioned site or facility after the initial report.</i></p>
		47	<p><i>The licensee and petroleum waste handler shall immediately and in any case not later than twenty four hours after the occurrence of the event, notify the Authority where:</i></p> <ul style="list-style-type: none"> <i>a) there are any incidents or accidents leading to spillage or harm to the environment or human health;</i> <i>b) radioactivity has been detected in the petroleum waste;</i> <i>c) the petroleum waste delivered does not meet the description in the petroleum waste manifest;</i> <i>d) the petroleum waste cannot be traced and has not reached its destination; or</i> <i>e) the petroleum waste has been mixed up or otherwise tampered with.</i>
		48	<p><i>The Authority or authorised officer may conduct regular inspections and monitoring of the petroleum waste management facilities.</i></p>
		50	<p><i>A person who:</i></p> <ul style="list-style-type: none"> <i>a) transports, treats, stores, disposes or otherwise handles petroleum waste without a licence issued under these Regulations;</i> <i>b) fails to comply with any direction given under these Regulations;</i> <i>c) fails to permit any inspection or monitoring authorized under these Regulations;</i> <i>d) fails to submit any report, data or documentation required under these Regulations;</i> <i>e) wilfully or recklessly makes a report required under these Regulations, or furnishes information which is in any respect false;</i> <i>f) refuses to grant the Authority or authorised officer access to the petroleum waste management facility for purposes of taking samples,</i> <i>g) disposes off petroleum waste from vessels including lorries and boats to an un approved disposal site or into the water;</i>





WASTE MANAGEMENT SPECIALIST ASSESSMENT

Name	Year ratified	Relevant sections	Description
			<i>h) dumps petroleum waste that is rejected by the petroleum waste handler commits an offence and is liable on conviction to a fine or imprisonment or both.</i>
		51	<i>Where a person is convicted of an offence under these Regulations, the court may, in addition to any other penalty imposed, make an order for the forfeiture of any funds, money instruments, documents, facilities, vehicles, crafts, vessels or equipment used in the commission of the offence.</i>
The Petroleum (Exploration, Development and Production) (National Content) Regulations (Ref. 21)	2016	10	Every licensee operator, contractors and subcontractors shall reserve the contracts for goods and services specified in the Schedule (includes waste management) to be supplied by Ugandan companies, Ugandan citizens and registered entities.
The Petroleum (Refining, Conversion, Transmission and Midstream Storage) (National Content) Regulations (Ref. 22)	2016	11	Every licensee operator, contractors and subcontractors shall reserve the contracts for goods and services specified in the Schedule (includes waste management) to be supplied by Ugandan companies, Ugandan citizens and registered entities.
The Petroleum (Exploration, Development and Production) (Health, Safety and Environment) Regulations (Ref. 23)	2016	13	A licensee shall prepare and retain a written major accident prevention policy to ensure a high level of protection of human health and the environment, which is reviewed in accordance with this Act.
		29	The licensee shall handle, store, transport or dispose of hazardous substances in accordance with standards approved by the relevant authority, best petroleum industry practices, regulations made under section 3(8) of the Act, the National Environment Act and the Occupational Safety and Health Act, 2006. The licensee shall ensure that containers for transportation and storage of hazardous substances are colour-coded and labelled in accordance with standards approved by the relevant authority and best petroleum industry practices to ensure easy identification. The licensee shall avoid using hazardous substances in the work place and where practicable, substitute the hazardous substance with another substance of less risk to human health and the environment.





WASTE MANAGEMENT SPECIALIST ASSESSMENT

Name	Year ratified	Relevant sections	Description
			The licensee shall keep a record of all hazardous substances contained at the facility or during petroleum activity including information on physical, chemical and hazardous properties; preventive safety measures and first aid treatment.
		30	<p>The licensee shall ensure that warning signs are displayed at appropriate distance about the presence of hazardous substances every area where hazardous substances are present or could cause a hazard to a person.</p> <p>The licensee shall, as far as practicable, provide automated warning and detection systems in areas where there is a likelihood of exposure to a hazardous substance.</p> <p>The licensee shall manage safety hazards related to handling and storage of liquid or gaseous substances depending on the quantities and type where the liquid or substances are accidentally released.</p> <p>The licensee shall minimise the conditions for reactive or catastrophic events related to liquid or gaseous substances, including fire and explosion.</p>
		38	The licensee shall ensure that each facility has a process safety system.
		126	The licensee shall actively contribute to the exchange of information with neighbouring activities and facilities within a geographic area to ensure that the people affected by the petroleum activities and facilities have a full overview at all times of the amounts of hazardous substances being handled.
		157	The licensee shall report promptly an accumulation, spill or leak of a hazardous substance.
		160	The licensee shall notify the relevant authority of the spillage of any hazardous substance inside the facility or during a petroleum activity.



WASTE MANAGEMENT SPECIALIST ASSESSMENT

Table 2: Summary of Relevant IFC Guidelines and Standards

Name	Year ratified	Relevant sections	Description
EHS Guidelines (Ref. 24)	2007	Introduction	<ul style="list-style-type: none"> ■ Provides examples of good international industry practice; ■ Intended to be read together with Industry Specific EHS Guidelines; and ■ Includes measures that should be achievable in new facilities by existing technology at reasonable costs.
		1.6 General Waste Management	<ul style="list-style-type: none"> ■ Applicable to both non-hazardous and hazardous waste; and ■ Provides recommendations for establishing a waste management system that addresses waste prevention, recycling and reuse, and treatment and disposal.
		Hazardous Waste Management	<ul style="list-style-type: none"> ■ Sets out additional practices for the management of hazardous waste. This includes waste storage, transportation, treatment and disposal, and monitoring.
		3.5 Transport of Hazardous Materials	<ul style="list-style-type: none"> ■ Sets out the requirements for the transport of hazardous materials; and ■ To be read in conjunction with the United Nations (UN) Model Regulations, and host country commitments under the Basel and Rotterdam conventions.
		3.7 Emergency Preparedness & Response	<ul style="list-style-type: none"> ■ Sets out the basic elements to be included in an Emergency Preparedness and Response Plan.
Industry Sector EHS Guidelines for Onshore O&G Development (Ref. 25)	2007	Introduction	<ul style="list-style-type: none"> ■ Provides measures specific to onshore O&G facilities that should be implemented in addition to General EHS Guidelines; and ■ Guidelines should be used when host country regulations are less stringent.
		1.1 Environment	<ul style="list-style-type: none"> ■ Sets out the environmental issues to be taken into consideration to address project-specific risks and potential impacts of an O&G facility.
		Wastewater	<ul style="list-style-type: none"> ■ Provides information on wastewater management, water conservation and reuse, along with wastewater and water quality monitoring programmes.
		<i>Produced water</i>	<ul style="list-style-type: none"> ■ Options to reduce the volume of produced water include adequate well management during well completion activities, recompletion of high water producing wells, use of downhole fluid separation techniques, where possible, and water shutoff techniques; ■ In order to minimise environmental hazards. production chemicals should be selected, taking into account their volume, toxicity, bioavailability, and bioaccumulation potential;





WASTE MANAGEMENT SPECIALIST ASSESSMENT

Name	Year ratified	Relevant sections	Description		
			<ul style="list-style-type: none"> ■ Main disposal options include in reinjection into the well to enhance oil recovery or injection into a dedicated disposal well drilled into a suitable geological formation. Other options include irrigation, dust control or use by another industry. Disposal into evaporation ponds is another disposal option; and ■ Discharge produced water should be treated to the below limits: <table border="1" style="width: 100%; border-collapse: collapse;"> <tr> <td style="width: 20%; text-align: center; vertical-align: middle;">Produced water</td> <td> <p style="margin: 0;">Treatment and disposal as per guidance in Section 1.1 of this document</p> <p style="margin: 0;">For discharge to surface waters or to land:</p> <ul style="list-style-type: none"> ○ Total hydrocarbon content: 10 mg/L ○ pH: 6 - 9 ○ BOD: 25 mg/L ○ COD: 125 mg/L ○ TSS: 35 mg/L ○ Phenols: 0.5 mg/L ○ Sulphide: 1 mg/L ○ Heavy metals (total)*: 5 mg/L ○ Chlorides: 600 mg/l (average), 1200 mg/L (maximum) </td> </tr> </table>	Produced water	<p style="margin: 0;">Treatment and disposal as per guidance in Section 1.1 of this document</p> <p style="margin: 0;">For discharge to surface waters or to land:</p> <ul style="list-style-type: none"> ○ Total hydrocarbon content: 10 mg/L ○ pH: 6 - 9 ○ BOD: 25 mg/L ○ COD: 125 mg/L ○ TSS: 35 mg/L ○ Phenols: 0.5 mg/L ○ Sulphide: 1 mg/L ○ Heavy metals (total)*: 5 mg/L ○ Chlorides: 600 mg/l (average), 1200 mg/L (maximum)
Produced water	<p style="margin: 0;">Treatment and disposal as per guidance in Section 1.1 of this document</p> <p style="margin: 0;">For discharge to surface waters or to land:</p> <ul style="list-style-type: none"> ○ Total hydrocarbon content: 10 mg/L ○ pH: 6 - 9 ○ BOD: 25 mg/L ○ COD: 125 mg/L ○ TSS: 35 mg/L ○ Phenols: 0.5 mg/L ○ Sulphide: 1 mg/L ○ Heavy metals (total)*: 5 mg/L ○ Chlorides: 600 mg/l (average), 1200 mg/L (maximum) 				
		<i>Hydrostatic testing water</i>	<ul style="list-style-type: none"> ■ Main options for disposal of hydrostatic test water includes injection into a disposal well or discharge to surface waters or land surface; ■ If hydrostatic test water is to be discharged to surface water or land, the following pollution prevention measures should be considered: <ul style="list-style-type: none"> ■ Use the same hydrotest water for multiple tests; ■ Reduce the need for chemicals by minimising the time that test water remains in the equipment or pipeline; ■ Carefully select chemical additives in terms of dose concentration, toxicity, biodegradability, bioavailability, and bioaccumulation potential; ■ Conduct toxicity testing as necessary using recognised test methodologies; ■ If significant quantities of chemically treated hydrostatic test waters are required to be discharged to a surface water body, water receptors both upstream and downstream of the discharge should be monitored; ■ If discharged to water, the volume and composition of the test water, as well as the stream flow or volume of the receiving water body, should be considered in selecting an appropriate discharge site; 		





WASTE MANAGEMENT SPECIALIST ASSESSMENT

Name	Year ratified	Relevant sections	Description		
			<ul style="list-style-type: none"> ■ Use break tanks or energy dissipaters (e.g. protective riprap, sheeting, tarpaulins) for the discharge flow; ■ Use sediment control methods (e.g. silt fences, sandbags or hay bales) to protect aquatic biota, water quality and water users from the potential effect of discharge; ■ If discharged to land, the discharge site should be selected to prevent flooding, erosion, or lowered agriculture capability of the receiving land; and ■ Water discharge during cleaning pig runs and pre-test water should be collected in holding tanks and should be discharged only after water quality testing. <p>■ Discharge of hydrostatic test water should be discharged to the below limits:</p> <table border="1" style="width: 100%; border-collapse: collapse;"> <tr> <td style="width: 30%; padding: 5px;">Hydrotest water</td> <td style="padding: 5px;">Treatment and disposal as per guidance in section 1.1 of this document. For discharge to surface waters or to land, see parameters for produced water in this table.</td> </tr> </table>	Hydrotest water	Treatment and disposal as per guidance in section 1.1 of this document. For discharge to surface waters or to land, see parameters for produced water in this table.
Hydrotest water	Treatment and disposal as per guidance in section 1.1 of this document. For discharge to surface waters or to land, see parameters for produced water in this table.				
		<i>Tank bottom waters</i>	<ul style="list-style-type: none"> ■ The accumulation of tank bottom waters should be minimised by regular maintenance of tank roofs and seals to prevent rainwater infiltration; ■ Tank bottom waters can potentially be routed to the produced water stream for treatment and disposal, if available; and ■ Tank bottom sludges should also be periodically removed and recycled or disposed of as a hazardous waste. 		
		<i>Generally oily water</i>	<ul style="list-style-type: none"> ■ Oily water from drip trays and liquid slugs from process equipment and pipelines should be routed to the closed drainage system. 		
		<i>Surface storage or disposal pits</i>	<ul style="list-style-type: none"> ■ Surface storage or disposal pits should be constructed outside environmentally sensitive location; ■ Wastewater pit construction and management measures should include: <ul style="list-style-type: none"> ■ Installation of a liner so that the bottom and sides of the pit have a coefficient of permeability of no greater than 1×10^{-7} cm per second (cm/sec); ■ Liners should be compatible with the material to be contained and of sufficient strength and thickness to maintain the integrity of the pit. Typical liners may include synthetic materials, cement/clay type or natural clays, although the hydraulic conductivity of natural liners should be tested to ensure integrity; 		





WASTE MANAGEMENT SPECIALIST ASSESSMENT

Name	Year ratified	Relevant sections	Description
			<ul style="list-style-type: none"> ▪ Construction to a depth of typically 5 m above the seasonal high water table; ▪ Installation of measures (e.g. careful siting, berms) to prevent natural surface drainage from entering the pit or breaching during heavy storms; ▪ Installation of a perimeter fence around the pit or installation of a screen to prevent access by people, livestock and wildlife (including birds); ▪ Regular removal and recovery of free hydrocarbons from the pit contents surface; ▪ Removal of pit contents upon completion of operations and disposal in accordance with the waste management plan; and ▪ Reinstatement of the pit area following completion of operations.
		Waste Management	<ul style="list-style-type: none"> ■ Sets out waste management guidelines for wastes streams specific to onshore O&G facilities; ■ Waste materials should be segregated into non-hazardous and hazardous wastes for consideration for reuse, recycling, or disposal; ■ Waste management planning should establish a clear strategy for wastes that will be generated including options for waste elimination, reduction or recycling or treatment and disposal, before any wastes are generate; and ■ A waste management plan documenting the waste strategy, storage (including facilities and locations) and handling procedures should be developed and should include a clear waste tracking mechanism to track waste consignments from the originating location to the final waste treatment and disposal location.
		<i>Drilling fluids and drilled cuttings</i>	<ul style="list-style-type: none"> ■ The following should be considered to reduce the volume of drilling fluids and drill cuttings requiring disposal: <ul style="list-style-type: none"> ▪ Use of high efficiency solids control equipment to reduce the need for fluid change out and minimising the amount of residual fluid on drilled cuttings; and ▪ Use of slim-hole multilateral wells and coiled tubing drilling techniques. ■ Feasible options for the treatment and disposal of drilling fluids and drilled cuttings, may include one, or a combination, the following: <ul style="list-style-type: none"> ▪ Injection of the fluid and cuttings mixture into a dedicated disposal well; ▪ Injection into the annular space of a well; ▪ Storage in dedicated storage tanks or lined pits prior to treatment, recycling, and/or final treatment and disposal;





WASTE MANAGEMENT SPECIALIST ASSESSMENT

Name	Year ratified	Relevant sections	Description
			<ul style="list-style-type: none"> ■ On site or off-site biological or physical treatment to render the fluid and cuttings non-hazardous prior to final disposal. This may include thermal desorption, bioremediation, land farming, or solidification with cement and/or concrete; ■ Final disposal options for non-hazardous drill cuttings may include the use in road construction material, construction fill, or disposal through landfill including landfill cover and capping material where appropriate; and ■ Recycling of spent fluids back to the vendors for treatment and reuse. ■ For drilling pits, pit closure should be completed as soon as practical, but no longer than 12 months, after the end of operations. If the drilling waste is to be buried in the pit following operations (the Mix-Bury-Cover disposal method), the following minimum conditions should be met: <ul style="list-style-type: none"> ■ The pit contents should be dried out as far as possible; ■ If necessary, the waste should be mixed with an appropriate quantity of subsoil (typically three parts of subsoil to one part of waste by volume); ■ Topsoil should not be used but it should be placed over the subsoil to fully reinstate the area; ■ A minimum of one meter of clean subsoil should be placed over the mix; and ■ The pit waste should be analysed and the maximum lifetime loads should be calculated. A risk based assessment may be necessary to demonstrate that internationally recognised thresholds for chemical exposure are not exceeded. ■ Pollution prevention and control measures for spent drilling fluids and drilled cuttings should include: <ul style="list-style-type: none"> ■ Careful selection of the fluid system; ■ Careful selection of fluid additives taking into account technical requirements, chemical additive concentration, toxicity, bioavailability and bioaccumulation potential; and ■ Monitoring and minimising the concentration of heavy metal impurities (mainly mercury and cadmium) in barite stock used in the fluid formulation.
		<i>Completion and well work-over fluids</i>	<ul style="list-style-type: none"> ■ Feasible options for the treatment and disposal of completion and well work-over fluids may include one, or a combination, the following:





WASTE MANAGEMENT SPECIALIST ASSESSMENT

Name	Year ratified	Relevant sections	Description		
			<ul style="list-style-type: none"> ■ Collection of the fluids if handled in closed systems and shipping to the original vendors for recycling; ■ Injection to a dedicated disposal well, where available; ■ Inclusion as part of the produced water waste stream for treatment and disposal. Spent acids should be neutralised before treatment and disposal; and ■ On site or off-site biological or physical treatment at an approved facility. <p>■ Completion and well work-over water should be treatment and disposed of in accordance with the following guidelines:</p> <table border="1" style="width: 100%; border-collapse: collapse;"> <tr> <td style="width: 30%; padding: 5px;">Completion and well work-over fluids</td> <td style="padding: 5px;"> Treatment and disposal as per guidance in Section 1.1 of this document. For discharge to surface waters or to land : <ul style="list-style-type: none"> ○ Total hydrocarbon content: 10 mg/L. ○ pH: 6 – 9 </td> </tr> </table>	Completion and well work-over fluids	Treatment and disposal as per guidance in Section 1.1 of this document. For discharge to surface waters or to land : <ul style="list-style-type: none"> ○ Total hydrocarbon content: 10 mg/L. ○ pH: 6 – 9
Completion and well work-over fluids	Treatment and disposal as per guidance in Section 1.1 of this document. For discharge to surface waters or to land : <ul style="list-style-type: none"> ○ Total hydrocarbon content: 10 mg/L. ○ pH: 6 – 9 				
		1.2 Occupational health and safety	<ul style="list-style-type: none"> ■ The design of the onshore facilities should reduce exposure of personnel to chemical substances, fuels, and products containing hazardous substances; and ■ For each chemical used, a Material Safety Data Sheet should be available and readily accessible on the facility. 		
		2.0 Performance indicators and monitoring	<ul style="list-style-type: none"> ■ Sets out effluent and waste guidelines for onshore O&G development (see Table 1 on page 22 of the guidelines); ■ Environmental monitoring programmes should be implemented to address all activities identified as having the potential to impact on the environment, during normal operations and upset conditions; ■ Monitoring frequency should be sufficient to provide representative data for the parameter being monitored; ■ Monitoring should be conducted by trained individuals following monitoring and record-keeping procedures and using properly calibrated and maintained equipment; and ■ Monitoring data should be analysed and reviewed at regular intervals and compared with the operating standards so that any necessary corrective actions can be taken. 		
		2.2 Occupational	<ul style="list-style-type: none"> ■ Occupational health and safety performance should be evaluated against internationally published exposure guidelines. This includes, but is not limited to the following: 		





WASTE MANAGEMENT SPECIALIST ASSESSMENT

Name	Year ratified	Relevant sections	Description
		health and safety	<ul style="list-style-type: none"> ■ Threshold Limit Value (TLV®) occupational exposure guidelines and Biological Exposure Indices (BEIs®) published by American Conference of Governmental Industrial Hygienists (ACGIH); ■ The Pocket Guide to Chemical Hazards published by the United States National Institute for Occupational Health and Safety (NIOSH); ■ Permissible Exposure Limits published by the Occupational Safety and Health Administration (OSHA) of the United States; and ■ Indicative Occupational Exposure Limit Values published by European Union member states.
EHS Guidelines for Waste Management Facilities (Ref. 26)	2007	Introduction	<ul style="list-style-type: none"> ■ Provides measures specific to new waste management facilities that should be implemented in addition to General EHS Guidelines; ■ Applicable to all facilities that manage industrial waste, including waste collection and transport, waste receipt, unloading, processing, and storage; landfill disposal; physio-chemical and biological treatment; and incineration projects; and ■ Guidelines should be used when host country regulations are less stringent.
		1.1.2 Industrial Hazardous Waste	<ul style="list-style-type: none"> ■ Applicable to wastes defined as 'hazardous' by local regulations or international conventions, based on the origin of the waste and its inclusion in hazardous waste lists.
		Waste Collection & Transport	<ul style="list-style-type: none"> ■ Sets out general measures to prevent spills and releases during waste transport and to facilitate emergency response if an accident does occur. Also includes recommendations specifically for hazardous waste collection and transport.
		Waste Receipt, Unloading, Processing and Storage	<ul style="list-style-type: none"> ■ Sets out general measures to control waste receipts and general measures to mitigate risks at industrial hazardous waste management facilities.
		<i>Spills and Releases</i>	<ul style="list-style-type: none"> ■ Sets out mitigation measures to address spills and releases resulting from overfills, vehicle accidents, and tank and piping failures.
		<i>Air Emissions</i>	<ul style="list-style-type: none"> ■ Sets out mitigation measures to minimise releases of particulate matter and volatile organic compounds from storage and waste processing facilities.





WASTE MANAGEMENT SPECIALIST ASSESSMENT

Name	Year ratified	Relevant sections	Description																											
		<i>Waste Effluents</i>	<ul style="list-style-type: none"> ■ Sets out mitigation measures to prevent, minimise and control water effluents. 																											
		Biological and Physio-Chemical Treatment	<ul style="list-style-type: none"> ■ Sets out recommended procedures to prevent, minimise, and control potential environmental impacts from chemical treatment; and ■ Also sets out specific measures for air emissions, water effluents, and waste residuals. 																											
		Hazardous Waste Incineration	<ul style="list-style-type: none"> ■ Sets out measures to manage air emissions, water effluents, and ash and residues; and ■ Includes air emission standards for hazardous waste incinerators in the EU and US- <table border="1" style="width: 100%; border-collapse: collapse;"> <caption style="background-color: #000080; color: white; text-align: center; padding: 2px;">Table 2. Air Emission Standards for Hazardous Waste Incinerators in the EU and US</caption> <thead> <tr style="background-color: #000080; color: white;"> <th style="text-align: center;">Parameter</th> <th style="text-align: center;">EU</th> <th style="text-align: center;">US *</th> </tr> </thead> <tbody> <tr> <td>Particulate Matter</td> <td style="text-align: center;">See Table 1</td> <td style="text-align: center;">1.5 mg/dscm</td> </tr> <tr> <td>Carbon Monoxide (CO) or Hydrocarbons (HC)</td> <td style="text-align: center;">See Table 1</td> <td style="text-align: center;">100 (CO) ppmv 10 (HC) ppmv</td> </tr> <tr> <td>Total Chlorine (HCl, Cl₂)</td> <td style="text-align: center;">See Table 1</td> <td style="text-align: center;">21 ppmv</td> </tr> <tr> <td>Mercury (Hg)</td> <td style="text-align: center;">See Table 1</td> <td style="text-align: center;">8.1 µg/dscm</td> </tr> <tr> <td>Semi-Volatile Metals (Pb, Cd)</td> <td style="text-align: center;">See Table 1</td> <td style="text-align: center;">10 µg/dscm</td> </tr> <tr> <td>Low Volatile Metals (As, Be, Cr)</td> <td style="text-align: center;">See Table 1</td> <td style="text-align: center;">25 µg/dscm</td> </tr> <tr> <td>Dioxins and Furans</td> <td style="text-align: center;">See Table 1</td> <td style="text-align: center;">0.11 dry APCD or WHB 0.20 other sources (ng TEQ/dscm)</td> </tr> <tr> <td>Destruction and Removal Efficiency</td> <td style="text-align: center;">See Table 1</td> <td style="text-align: center;">99.99% – 99.9999%</td> </tr> </tbody> </table> <p style="font-size: small; margin-top: 5px;"> Source: US EPA National Emission Standards for Commercial and Industrial Solid Waste Incineration Units, 40 CFR Part 63 Subpart EEE. </p> <p style="font-size: x-small; margin-top: 5px;"> Notes: a All values corrected to 7% oxygen TEQ = toxicity equivalent; APCD = air pollution control device; WHB = waste heat boiler; mg/m³ = milligrams per cubic meter; mg/dscm = milligrams per dry standard cubic meter; ppmv = parts per million by volume; </p>	Parameter	EU	US *	Particulate Matter	See Table 1	1.5 mg/dscm	Carbon Monoxide (CO) or Hydrocarbons (HC)	See Table 1	100 (CO) ppmv 10 (HC) ppmv	Total Chlorine (HCl, Cl ₂)	See Table 1	21 ppmv	Mercury (Hg)	See Table 1	8.1 µg/dscm	Semi-Volatile Metals (Pb, Cd)	See Table 1	10 µg/dscm	Low Volatile Metals (As, Be, Cr)	See Table 1	25 µg/dscm	Dioxins and Furans	See Table 1	0.11 dry APCD or WHB 0.20 other sources (ng TEQ/dscm)	Destruction and Removal Efficiency	See Table 1	99.99% – 99.9999%
Parameter	EU	US *																												
Particulate Matter	See Table 1	1.5 mg/dscm																												
Carbon Monoxide (CO) or Hydrocarbons (HC)	See Table 1	100 (CO) ppmv 10 (HC) ppmv																												
Total Chlorine (HCl, Cl ₂)	See Table 1	21 ppmv																												
Mercury (Hg)	See Table 1	8.1 µg/dscm																												
Semi-Volatile Metals (Pb, Cd)	See Table 1	10 µg/dscm																												
Low Volatile Metals (As, Be, Cr)	See Table 1	25 µg/dscm																												
Dioxins and Furans	See Table 1	0.11 dry APCD or WHB 0.20 other sources (ng TEQ/dscm)																												
Destruction and Removal Efficiency	See Table 1	99.99% – 99.9999%																												





WASTE MANAGEMENT SPECIALIST ASSESSMENT

Name	Year ratified	Relevant sections	Description																																																																																																		
		Landfilling	<ul style="list-style-type: none"> ■ Sets out additional measures to prevent, minimise, and control potential environmental impacts from landfilling, including leachate generation, groundwater and leachate monitoring, landfill gas, and closure and post-closure; and ■ Includes effluent standards for hazardous waste landfills in the EU and US– <table border="1" style="width: 100%; border-collapse: collapse; text-align: center;"> <caption>Table 4—Effluent Standards for Landfills in the US</caption> <thead> <tr> <th rowspan="3">Parameter</th> <th rowspan="3">Units</th> <th colspan="4">Guideline*</th> </tr> <tr> <th colspan="2">Hazardous Waste Landfills</th> <th colspan="2">MSW Landfills</th> </tr> <tr> <th>Daily Max</th> <th>Monthly Avg.</th> <th>Daily Max</th> <th>Monthly Avg.</th> </tr> </thead> <tbody> <tr> <td>BOD₅</td> <td></td> <td>220</td> <td>.56</td> <td>140</td> <td>57</td> </tr> <tr> <td>pH</td> <td></td> <td>6-9</td> <td>6-9</td> <td>6-9</td> <td>6-9</td> </tr> <tr> <td>Total Suspended Solids</td> <td>mg/L</td> <td>88</td> <td>.27</td> <td>88</td> <td>.27</td> </tr> <tr> <td>Ammonia (as N)</td> <td>mg/L</td> <td>10</td> <td>4.9</td> <td>10</td> <td>4.9</td> </tr> <tr> <td>Arsenic</td> <td>mg/L</td> <td>1.1</td> <td>0.54</td> <td></td> <td></td> </tr> <tr> <td>Chromium</td> <td>mg/L</td> <td>1.1</td> <td>0.46</td> <td></td> <td></td> </tr> <tr> <td>Zinc</td> <td>mg/L</td> <td>0.035</td> <td>0.096</td> <td>0.20</td> <td>0.11</td> </tr> <tr> <td>o-Terpineol</td> <td>mg/L</td> <td>0.042</td> <td>0.019</td> <td>0.033</td> <td>0.016</td> </tr> <tr> <td>Aniline</td> <td>mg/L</td> <td>0.024</td> <td>0.016</td> <td></td> <td></td> </tr> <tr> <td>Benzoic Acid</td> <td>mg/L</td> <td>0.119</td> <td>0.073</td> <td>0.12</td> <td>0.071</td> </tr> <tr> <td>Naphthalene</td> <td>mg/L</td> <td>0.059</td> <td>0.022</td> <td></td> <td></td> </tr> <tr> <td>p-Cresol</td> <td>mg/L</td> <td>0.024</td> <td>0.016</td> <td>0.026</td> <td>0.014</td> </tr> <tr> <td>Phenol</td> <td>mg/L</td> <td>0.048</td> <td>0.029</td> <td>0.026</td> <td>0.016</td> </tr> <tr> <td>Pyridine</td> <td>mg/L</td> <td>0.072</td> <td>0.026</td> <td></td> <td></td> </tr> </tbody> </table> <p style="font-size: small; margin-top: 5px;">Source: U.S. EPA Effluent Guidelines for Controlled Waste Treatment, 40 CFR Part 437.</p>	Parameter	Units	Guideline*				Hazardous Waste Landfills		MSW Landfills		Daily Max	Monthly Avg.	Daily Max	Monthly Avg.	BOD ₅		220	.56	140	57	pH		6-9	6-9	6-9	6-9	Total Suspended Solids	mg/L	88	.27	88	.27	Ammonia (as N)	mg/L	10	4.9	10	4.9	Arsenic	mg/L	1.1	0.54			Chromium	mg/L	1.1	0.46			Zinc	mg/L	0.035	0.096	0.20	0.11	o-Terpineol	mg/L	0.042	0.019	0.033	0.016	Aniline	mg/L	0.024	0.016			Benzoic Acid	mg/L	0.119	0.073	0.12	0.071	Naphthalene	mg/L	0.059	0.022			p-Cresol	mg/L	0.024	0.016	0.026	0.014	Phenol	mg/L	0.048	0.029	0.026	0.016	Pyridine	mg/L	0.072	0.026		
Parameter	Units	Guideline*																																																																																																			
		Hazardous Waste Landfills				MSW Landfills																																																																																															
		Daily Max	Monthly Avg.	Daily Max	Monthly Avg.																																																																																																
BOD ₅		220	.56	140	57																																																																																																
pH		6-9	6-9	6-9	6-9																																																																																																
Total Suspended Solids	mg/L	88	.27	88	.27																																																																																																
Ammonia (as N)	mg/L	10	4.9	10	4.9																																																																																																
Arsenic	mg/L	1.1	0.54																																																																																																		
Chromium	mg/L	1.1	0.46																																																																																																		
Zinc	mg/L	0.035	0.096	0.20	0.11																																																																																																
o-Terpineol	mg/L	0.042	0.019	0.033	0.016																																																																																																
Aniline	mg/L	0.024	0.016																																																																																																		
Benzoic Acid	mg/L	0.119	0.073	0.12	0.071																																																																																																
Naphthalene	mg/L	0.059	0.022																																																																																																		
p-Cresol	mg/L	0.024	0.016	0.026	0.014																																																																																																
Phenol	mg/L	0.048	0.029	0.026	0.016																																																																																																
Pyridine	mg/L	0.072	0.026																																																																																																		
		Occupational Health & Safety	<ul style="list-style-type: none"> ■ Sets out additional mitigation measures to prevent, minimise, and control accidents and injuries, chemical exposure and exposure to pathogens and vectors. 																																																																																																		





WASTE MANAGEMENT SPECIALIST ASSESSMENT

Table 3: Summary of CNOOCs Own Policies, Guidelines and Standards

JVP	Name	Year ratified	Description
CNOOC	Waste Management Specification CUL-QHSE-L3(GE)-053 (Ref. 27)	N/A	<ul style="list-style-type: none"> ■ CNOOC policy to properly and safely manage all hazardous and non-hazardous waste from its generation to ultimate disposition, to prevent/minimize risks to human health and the environment. ■ The policy applies to all wastes generated from operations focusing on exploration operations (seismic surveys and exploration drilling), field development, camp activity, as well as office activities.
	Health, Safety & Environment Handbook (Ref. 28)	N/A	<ul style="list-style-type: none"> ■ Sets out the “5 DONT’s until DOs” safety rules in the workplace; ■ Identifies 10 high risk activities; ■ Sets out the HSE requirements for each of these 10 high risk activities.
	CNOOC, Kingfisher Field Development Project, Waste Management Study Report KF-FD-RPT-GEN-SA-1027 REV B (Ref. 35).	2017	<ul style="list-style-type: none"> ■ Kingfisher Field Development Project regarding: <ul style="list-style-type: none"> ▪ Types of Waste and Generation Source, ▪ Estimates of quantities, ▪ Mitigation methods and waste management, and ▪ Waste management execution plan.





3.0 WASTE BASELINE IN THE LAKE ALBERT OIL FIELDS AREA

3.1 Waste Generation

Section 3.0 provides background to the waste specialist study of the KDA area for CNOOC based on the development of the Lake Albert oil fields area by all three O&G companies. It provides the background information about amounts and types of non-hazardous waste (source: Atacama report dated July 2017, Ref. 30) and hazardous waste (source: Golder report 1546406, Ref. 31) expected to be generated during the different phases of field development.

3.1.1 Non-Hazardous Waste

3.1.1.1 Waste Quantification

The table below provides the summary findings of the non-hazardous waste quantities expected to be generated by the development of the Lake Albert oil fields area.

Table 4: Waste Quantification of the Lake Albert Oil Fields Area (Ref. 30)

	Waste Category	Quantities	Additional Description
Construction (2017 - 2021)	Solid Waste	94,500 mT	Majority of which will be construction and demolition (C&D) wastes with lesser quantities of municipal wastes.
	Liquid Waste	2,040,000 l (2,040 m ³)	Estimated grey water quantities
Operations Phase (2021 – 2045)	Solid Waste	400,000 mT	Will mainly be composed of municipal solid waste - mainly food waste, and industrial solid waste
	Liquid Waste	1,632,000 l (1632 m ³)	Estimated grey water quantities
		-	-
		-	Storm-water from Non-process areas

3.1.1.2 Waste Characterisations

For the non-hazardous waste streams expected to be generated, below is a summary of each waste stream across the development.

Table 5: Summary of waste streams and constituent non-hazardous waste composition expected to be generated from the Lake Albert Oilfield Development (Ref. 30)

Waste Stream	Non-hazardous waste composition per waste stream	Overall Non-hazardous waste types
Industrial Solid Wastes	Plant and vegetative materials	■ Food and vegetative wastes
	Plastics	
	Paper (including cardboard)	■ Plastics
	Metal (including scrap metal and offcuts)	
	Glass	■ Paper
	Rubber	
	Wood	■ Metal
	Construction and Demolition (C&D) wastes	
	Miscellaneous wastes (e.g. insulation, used tyres)	■ Glass
Food Wastes		
		■ Rubber





Waste Stream	Non-hazardous waste composition per waste stream	Overall Non-hazardous waste types
Municipal Solid Wastes (MSW)	Plastics	<ul style="list-style-type: none"> ■ Wood ■ C&D wastes ■ Grey water ■ Boiler blowdown water ■ Storm water from non-process areas ■ Miscellaneous wastes (e.g. insulation, used tyres, used parts, hoses, textile and leather)
	Paper	
	Metal (including metal cans)	
	Glass (including bottles and containers)	
	Wood	
	Miscellaneous wastes (e.g. textile and leather)	
Transport and Automotive Wastes	Plastics	
	Paper (including cardboard)	
	Scrap Metal	
	Miscellaneous wastes (e.g. used parts, used tyres, hoses)	
Industrial & Municipal Wastewater and Sewage	Grey Water	
	Boiler blowdown water	
	Storm water from non-process areas	

Based on previous waste characterisations done in the CNOOC KDA; it is expected that the relative composition of the different non-hazardous solid wastes generated in the Lake Albert Oilfield will approximately be as provided in the table below.

Table 6: Expected Non-hazardous Solid Waste Composition (Ref. 30)

Waste Type	Estimated Composition
Food &Vegetative wastes	43%
Plastics	27%
Paper	20%
Metal	4%
Glass	1%
Rubber	1%
Wood	1%
Miscellaneous wastes	3%

Additionally, based on previous waste generation forecasts done for the CNOOC KDA, it is expected that the highest quantities of non-hazardous wastes will be generated during peak construction; higher quantities generated during post-construction phase; high quantities generated during early operations; and low quantities generated during the post-closure of the facilities (Ref. 30).





3.1.2 Hazardous Waste

The table below shows of the main types of hazardous waste that was generated during the exploration and appraisal phase (E&A) or is likely to be generated during the construction and production (C&P), and decommissioning phases for the Lake Albert oil fields area development by the three O&G companies.

Table 7: Hazardous Wastes at the Phases of Oil Field Development

Waste category	Waste type	Activity/Source	Phase		
			Exploration and appraisal	Construction and production	Decommissioning
Drill cuttings	-	Development drilling	✓	✓	
Drilling fluids	Water Based Drilling Fluids (WBDFs)	Development drilling	✓	✓	
	Non-Aqueous Drilling Fluids (NADFs)	Development drilling	✓	✓	
Associated Hazardous Wastes	Batteries (wet and dry)	Offices, workshop	✓	✓	✓
	Chemicals residue	Equipment and material preparation	✓	✓	
	Completion and well work-over fluids	Development drilling	✓	✓	
	Contaminated containers (e.g. oil drums)	Liquid handling (including water and oil/chemicals)	✓	✓	✓
	Contaminated hydrotest water	Pre-commissioning and Commissioning	✓	✓	
	Contaminated personal protective equipment	Staff	✓	✓	✓
	Contaminated scrap metal	Various activities	✓	✓	✓
	Electrical/electronic waste	Electrical wiring	✓	✓	
	Foam	Pipe insulation	✓	✓	
	Medical waste	Temporary and permanent medical facilities	✓	✓	✓





WASTE MANAGEMENT SPECIALIST ASSESSMENT

Waste category	Waste type	Activity/Source	Phase		
			Exploration and appraisal	Construction and production	Decommissioning
	Naturally Occurring Radioactive Materials (NORM)	Development drilling	✓	✓	
	Oil contaminated soil	General maintenance	✓	✓	
	Oily rags, filters, etc.	General maintenance	✓	✓	
	Oily sludges (from the bottom of vessels)	General maintenance	✓	✓	
	Pigging wastes	Pre-commissioning, Commissioning and general pipeline maintenance	✓	✓	
	Paint residue (solid and liquid)	General maintenance	✓	✓	
	Pipe dope	Pipe stringing and bending	✓	✓	
	Sewage	Sewage treatment plant, welfare units and portable toilets	✓	✓	✓
	Spent fluorescent tubes and lamps	General maintenance	✓	✓	✓
	Spent welding rods, epoxy coatings, grinder wheels, visors, shot blast, etc.	Welding, inspection and coating	✓	✓	✓
	Used aerosol cans	General maintenance	✓	✓	
	Used fabrication material (e.g. paint, cement, insulation)	Fabrication	✓	✓	
	Used lubricating/hydraulic oil, grease, solvents	General maintenance and chemical injection	✓	✓	





Waste category	Waste type	Activity/Source	Phase		
			Exploration and appraisal	Construction and production	Decommissioning
	and absorbent materials				

It can be seen that the wastes have been grouped into three broad categories; namely drill cuttings, drilling fluids and associated hazardous wastes. These categories are primarily based on the technologies used to treat and/or dispose of these types of waste, and are described in the sub-sections below.

3.1.2.1 Drill Cuttings

Drill cuttings refer to the particles of crushed rock produced by the action of the rotary drill bit as it digs into the earth (IOGP, 2016, see Ref. 29). The rotation of the drill bit at the bottom of the hole breaks off small chips of rock, deepening the hole. Drilling fluid (see Section 3.1.2.2), which exits the drill bit is used to remove the cuttings, allowing the drill bit to proceed. It does this by suspending the cuttings and carrying them up the annulus to the surface where they are separated from the drilling fluid by the solids control equipment on the drill rig.

The drill cuttings are therefore a mixture of the natural rock and soil material, and the drilling fluid (e.g. base fluid, brine, barite and emulsifiers). The hydrocarbon content of the cuttings is referred to as the oil on cuttings. The retention of drilling fluids on cuttings represents a financial loss as new fluids must be purchased to replace those disposed of as waste.

The physical and chemical characteristics of the drill cuttings is dependent on the formations drilled, and the type and quantity of any retained drilling fluid (Ref. 29). Drill cuttings range in size from clay-sized particles (~0.002 mm) to coarse gravel (>30 mm) and are irregular and angular. The chemical and mineral composition of cuttings reflects that of the rock layers being penetrated by the drill.

The choice of treatment and final disposal of the drill cuttings is dependent on a number of factors, including the type of drilling fluids used, local regulations, treatment/disposal facility limitations, environmental considerations, and cost-benefit analysis (Ref. 29).

3.1.2.2 Drilling Fluids

Drilling fluids are often referred to as 'muds', and are mixtures of fine-grained solids, inorganic salts, and organic compounds dissolved or dispersed/suspended in the base fluid (Ref. 29).

As shown in Figure 2 below, the drilling fluid is pumped from the mud tanks on the rig, down the drill pipe, exiting through holes in the drill bit, and returns to the surface via the annulus, which is the space between the drill pipe and the drill casing or rock wall of the drilled hole.



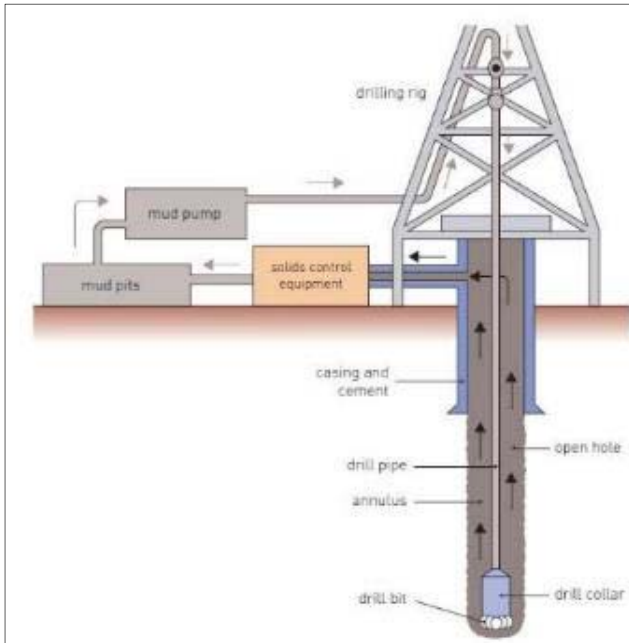

Figure 2: Drilling Fluids Circulating System of a Drilling Rig and Well (Ref. 29)

Drilling fluids are normally reused until their properties become unsuitable for the particular phase of the drilling operation. The two most commonly used drilling fluids are:

- Water based drilling fluids (WBDFs); and
- Non-aqueous drilling fluids (NADFs).

Water-Based Drilling Fluids

Water-based drilling fluids (WBDFs), also referred to as water-based muds (WBMs), are the most widely used, and are generally less expensive than other fluids (Ref. 29).

WBDFs are formulated mixtures of clays, natural and synthetic organic polymers, mineral weighting agents, and other additives dissolved or suspended in fresh water, brine, saturated brine, or a formatted brine. The type of fluid used is dependent on the anticipated well conditions.

Table 8 below presents a number of functional categories of additives available for modifying the physical/chemical properties of a Water-based drilling fluid to solve specific downhole problems, enabling it to function optimally during drilling of a well.

Table 8: Functional Categories of Additives Sometimes Used in Water-Based Drilling Fluids (Ref. 29 Section 11)

Category	Example
Weighting materials	Barite, calcium carbonate, ilmenite or hematite
Viscosifiers	Clay, organic polymers
Filtrate reducers	Starch, clay, lignite, polymers
pH control	Inorganic acids and bases, most often caustic soda
Shale control	Soluble salts such as potassium chloride, amines, glycols)
Lost circulation materials	Inert insoluble solids such as calcium carbonate, ground nut shells, graphite, mica and cellulose fibres
Lubricants	Water-based lubricants, glycols and beads





Category	Example
Emulsifiers, surfactants	Detergents, soaps, organic fatty acids
Thinners	Lignite, lignosulfonates, polymers
Flocculants	Inorganic salts, acrylamide polymers
Bactericides	Glutaraldehyde, triazine disinfectants
Pipe-freeing agents	Water-based lubricants, enzymes, surfactants
Defoamers	Alcohols, silicones, aluminium stearate, alkyl phosphates
Calcium reducers	Sodium carbonate, bicarbonate, polyphosphates
Corrosion inhibitors	Amines, phosphates
Temperature stability	Acrylic or sulfonated polymers, lignite, lignosulfonate

WBDFs rarely contain more than ten of the above additives, with most added in small amounts. Furthermore, the composition of the water-based drilling fluids may also vary during drilling of a single well because different additives may be required to drill different well sections through varying geologic formations. As shown in Figure 3 below, water-based drilling fluids typically comprise mostly water (or brine) (76%), a weighting material such as barite (14%), and a mud viscosifier, such as bentonite clay or biologically derived organic polymer (6%).

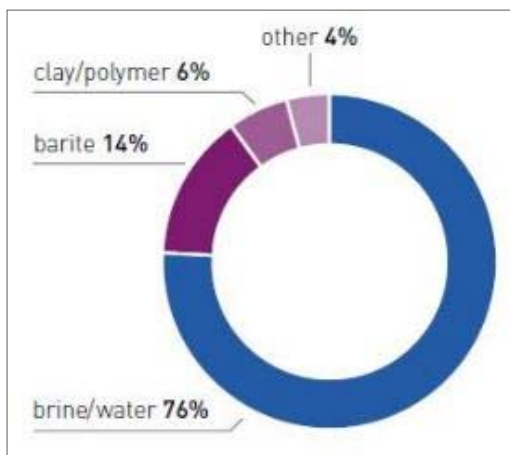

Figure 3: Typical Composition (by weight percentage) of Water-Based Drilling Fluid (IOGP, 2016: 12)

Non-Aqueous Drilling Fluids

Non-aqueous drilling fluids (NADFs), also referred to as synthetic-based muds (SBMs) are drilling fluids with an oil or synthetic base fluid (Ref. 29).

NADFs are used in some drilling operations where WBDFs are not well suited (Ref. 29). For example, as NADFs are intrinsically lubricous, they are better suited to the drilling of highly deviated, extended reach, and horizontal wells than WBDFs. NADFs are also more stable than WBDFs and therefore better suited to deep, high pressure/high temperature wells.

NADFs are typically formulated using diesel, mineral oil, or low-toxicity olefins, paraffins and esters (Ref. 29).

The olefins, paraffins and esters are often referred to as 'synthetics'. In a NADF, the ratio of the non-aqueous percentage to the water percentage in the liquid phase is referred to as the oil/water ratio. This typically ranges between 70/30 and 80/20.

As with WBDFs, chemicals are added to non-aqueous drilling fluids to provide the same or similar functions as Water-based drilling fluid additives. In Figure 4 below, it can be seen that NADFs typically comprise



mostly non-aqueous fluid (46%), a weighting material, such as barite (33%), brine (18%), and emulsifiers (2%).

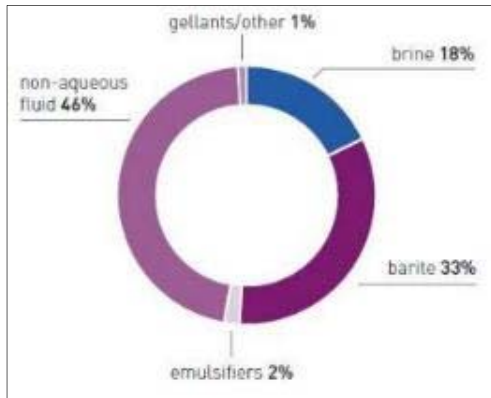

Figure 4: Typical Composition (by weight percentage) of non-aqueous drilling fluids (Ref. 29, Section 12)

The toxicity of the drilling fluid can be determined by the aromatic hydrocarbon concentrations. According to the IOGP, NADFs can be classified into three groups, namely I, II and III (see Table 9 below).

Table 9: Classification of non-aqueous drilling fluids (Ref. 29, Section 14)

Category	Properties
Group I: High Aromatic Content	<ul style="list-style-type: none"> Group I non-aqueous drilling fluids are defined as containing more than 5% by weight aromatic hydrocarbons, with polycyclic aromatic hydrocarbons (PAHs) concentrations greater than 0.35% by weight; These were the first NADFs used and include crude oil, diesel and conventional mineral oils. Diesel and mineral oils are refined from crude oil and are complex mixtures of liquid hydrocarbons, including paraffins, aromatic hydrocarbons, and PAHs; and Due to concerns about toxicity, Group I non-aqueous drilling fluids are generally only used where safe onshore disposal or reinjection of cuttings is possible.
Group II: Medium Aromatic Content	<ul style="list-style-type: none"> Group II non-aqueous drilling fluids are also developed from refining crude oil, but the distillation process is controlled to the extent that total aromatic hydrocarbon concentrations (between 0.5% and 5%) are less than those of Group I non-aqueous drilling fluids and PAH content is less than 0.35%, but greater than 0.001%; and These fluids were developed to address concerns over the potential toxicity of diesel-based fluids.
Group III: Low to Negligible Aromatic Content	<ul style="list-style-type: none"> Group III non-aqueous drilling fluids contain less than 0.5% by weight total aromatics and less than 0.001% by weight PAH; These fluids are produced either through more extensive refining of petroleum stock or by the synthesis of a specific, well defined organic fluid from non-petroleum precursors; and The most frequently used synthetic hydrocarbons are esters, polymerised olefins, and synthetic branched and normal paraffins.





3.1.2.3 Associated Hazardous Wastes

In addition to the drill cuttings and drilling fluids, a wide range of small volume waste streams associated with the exploration and appraisal, and construction and production phases are also generated. This includes following types of hazardous waste (see Table 10).

Table 10: Associated Hazardous Waste Inventory

Waste type	Description
Batteries (wet and dry)	Wet-cell batteries (lead acid) are typically used in vehicles, and contain a liquid electrolyte, such as sulfuric acid, which may be hazardous. In contrast, dry cell batteries do not contain a liquid. These batteries may contain alkaline, lithium, mercury, silver oxide, zinc, lithium ion, nickel-cadmium, or nickel metal hydride, which are also hazardous.
Spent chemicals and residue	Chemical hazardous wastes are solids, liquids, or gases that display either a hazardous characteristic or are listed specifically by name as hazardous. The four hazardous waste characteristics include ignitability, corrosivity, reactivity, and toxicity.
Contaminated containers	Containers, such as oil drums that have been used for the storage and transport of hazardous substances, such as chemicals or oily waste.
Contaminated hydrotest water	Hydrotest waster is used for the pressure testing of equipment and pipelines. Chemical additives, corrosion inhibitors, oxygen scavengers, and dyes) may be added to the water to prevent internal corrosion or to identify leaks.
Contaminated personal protective equipment	Personal protective equipment contaminated by hazardous substances, such as chemicals or oily waste.
Contaminated scrap metal	Scrap metal contaminated by hazardous substances, such as chemicals or oily waste.
Completion and well work-over fluids	Completion and well work-over fluids are typically used to clean the wellbore and stimulate the flow of hydrocarbons, or simply used to maintain downhole pressure. Once used these fluids may contain contaminants including solid material, oil, and chemical additives.
Electrical/electronic waste	Electrical/electronic waste, such as mobile phones, computers, and laboratory equipment, contain hazardous substances such as heavy metals.
Foam	Water, surfactants, and air are combined to create a stiff foam which is circulated as a drilling fluid.
Medical waste	Certain types of medical wastes are classified as a biohazard as these could potentially lead to the spread of infectious disease.
Oil contaminated soil	Soils (including produced sands) contaminated by oily waste.
Oily rags, filters etc.	Rags, filters and other consumables contaminated by oily waste.
Oily sludges (from the bottom of vessels)	Oily sludges that collect at the bottom of vessels.
Pigging wastes	Wastes resulting from the removal or recovery of residual oils in the pipelines.
Paint residue (solid and liquid)	Residual paints which may contain hazardous substances.





Waste type	Description
Pipe dope	Pipe dope is used as a pre-connecting pipe conditioner, which may contain high levels of lead.
Sewage	Sewage is classified hazardous as it can contain (infectious) pathogens which pose risk to the environment and human health.
Spent fluorescent tubes and lamps	Fluorescent tubes and lamps contain mercury which is classified as hazardous.
Spent welding rods, epoxy coatings, grinder wheels, visors, shot blast etc.	Workshop consumables that may be contaminated by hazardous substances, such as chemicals or oily wastes.
Used aerosol cans	Aerosol cans may contain paint, lubricants, glues, pesticides, and many other chemicals that are classified as hazardous.
Used fabrication material (e.g. paint, cement, insulation)	Certain fabrication materials contain hazardous substances such as paints, cements or insulation.
Used lubricating/hydraulic oil, grease, solvents and absorbent materials	Residual lubricating/hydraulic oil, grease, solvents and absorbent materials which pose risk to the environment and human health.
Naturally Occurring Radioactive Materials (NORM) – not expected	NORM can be carried up to the surface by the produced fluids and/or form scale on the inside of piping

3.2 Waste Inventory during Phases of Project Development

This section presents the estimated quantities of the three hazardous waste categories that will be generated in the construction and production, and decommissioning phases based on information provided by the three O&G companies.

These estimates will be cross-referenced with the carrying capacity of the waste transporters and treatment/disposal capacity of the treatment/disposal facilities in the sections to follow to determine if there is sufficient capacity to collect, transport and treat/dispose of the petroleum waste streams from the construction and production, and decommissioning phases.

Table 11 below presents estimates of the total quantity of drill cuttings, drilling fluids, and associated hazardous wastes that may be generated in the construction and production, and decommissioning phases.

Table 11: Estimated Quantities of Hazardous Waste

Waste type	Exploration & appraisal		Construction & production		Decommissioning	
	Low	High	Low	High	Low	High
Drill cuttings	56 011 ¹	77 900 ²	300 000 ³	344 755 ⁴	nominal	nominal

¹ Based on information provided by the technical working group representative (Total) via email on 17/01/2017, the technical working group representative (Tullow) via email on 27/01/2017, and information provided in the Terms of Reference (CNOOC), Page 7.

² Based on information provided in the Terms of Reference, Page 7.

³ Based on information provided in the Terms of Reference, Page 7.

⁴ Extrapolated using information provided for the exploration and appraisal phase (i.e. average drill cuttings per well in the exploration and appraisal phase multiplied by the total number of wells in the construction and production phase).





Waste type	Exploration & appraisal		Construction & production		Decommissioning	
	Low	High	Low	High	Low	High
Drilling fluids	9 413 ⁵	12 300 ⁶	57 938 ⁷	128 500 ⁸	nominal	nominal
Associated hazardous wastes	-	34 528 ⁹	-	-	-	181 185 ¹⁰

3.3 Waste Management Facilities

3.3.1 Hazardous Waste Management Facilities

Table 12 below lists the hazardous waste companies that were surveyed as part of Golder’s recent study on hazardous waste management in the Lake Albert oil fields development area (Golder project: 1546406, Ref. 31). At the time of surveys (November 2016) some of these companies were not licenced to transport, store and/or treat/dispose of hazardous waste. These companies were however still included in the study as they have or will the capacity, subject to obtaining the necessary licence(s) to manage hazardous waste.

Table 12: Hazardous Waste Companies Surveyed

Company	Transport		Treatment / Disposal	
	Licensed	Not Licensed	Licensed	Not Licensed
Allways Environmental				✓
Bemuga Forwarders		✓		
De Waste (U)	✓			
EnviroServ Uganda Ltd			✓	
Epsilon (U) Ltd		✓	✓	
Global Network Ltd	✓			
Green Label Services Ltd		✓	✓	
Luwero Industries	✓		✓	
Swift Waste Masters Ltd	✓			
White Nile Consults			✓	

3.3.1.1 Hazardous Waste Transporters

Five waste companies transport hazardous waste in the oil field development area, namely:

- Bemuga Forwarders (Pty) Ltd¹¹ (Bemuga);
- De Waste (U) Ltd (De Waste);
- Green Label Services Ltd (Green Label);

⁵ Based on information provided by the technical working group representative (Total) via email on 17/01/2017 and the technical working group representative (Tullow) via email on 27/01/2017, and information provided in the Terms of Reference (CNOOC), Page 7.

⁶ Based on information provided in the Terms of Reference, Page 7.

⁷ Extrapolated using information provided for the exploration and appraisal phase (i.e. average drilling fluids per well in the exploration and appraisal phase multiplied by the total number of wells in the construction and production phase).

⁸ Based on information provided in the Terms of Reference, Page 7 (i.e. 30% of waste not being drill cuttings).

⁹ Based on information provided by the technical working group representative (Total) via email on 17/01/2017 and the technical working group representative (Tullow) via email on 27/01/2017, and information provided in the Terms of Reference (CNOOC), Page 7.

¹⁰ Extrapolated using information provided for the exploration and appraisal phase (i.e. average general hazardous waste per well in the exploration and appraisal phase multiplied by the total number of wells in the construction and production phase).





- Global Networks Ltd (Global Networks); and
- Swift Waste Masters Ltd (Swift).

Table 13 below provides an overview of these waste companies, including the number of vehicles, the average carrying capacity of the vehicles, the average price paid for these vehicles and the combined carrying capacity of the vehicles for each type of waste. It can be seen that in total, there is capacity to transport 880 tonnes of drill cuttings, 581 kilolitres of drilling fluids, and 134 tonnes of general hazardous waste.

It is understood (from workshops held in mid-May with hazardous waste management companies including hauliers) that once the Lake Albert oil fields area moves from the exploration and appraisal phases to the construction and production phases of field development, that Ugandan waste transporters will invest in the additional vehicles required to appropriately transport the waste types to the various waste managed facilities in Uganda to accommodate any current shortfall in current carrying capacity to deal with the waste types anticipated.

Table 13: Overview of Uganda Hazardous Waste Transporters

Type of waste	Type of vehicle	Number of vehicles	Average capacity of vehicles	Combined capacity of vehicles (tonnes)
Drill cuttings	Modified dump truck	56 ¹²	15 t	880
Drilling fluids	Vacuum tanker	27	19 kl	581
General hazardous waste	Box-body truck	21	6.5 t	134

Figure 5 below presents examples of some of the vehicles used to transport the 'legacy waste' from the generators to the treatment/disposal facilities.



Figure 5: Examples of Modified Dump Truck (left), Vacuum Tanker (centre) and Box-body Truck (right)

3.3.1.2 Hazardous Waste Treatment/Disposal Facilities

Only five waste companies own/operate a hazardous waste treatment/ disposal facilities in the oil fields development area.¹³ Figure 6 shows the location of these facilities. The companies are as follows:

- EnviroServ Uganda Ltd (EnviroServ);
- Epsilon (U) Ltd (Epsilon);
- Green Label Services Ltd (Green Label);
- Luwero Industries Ltd (Luwero);

¹² Note that Bemuga's vehicles have largely been repurposed for use in the construction industry, but were included in the analysis as these vehicles can, if required be modified to transport to transport drill cuttings.

¹³ The other 12 licensed waste handlers have been excluded from the assessment as their treatment / disposal facilities are exclusively for their own waste.





- White Nile Consultants Ltd (White Nile); and
- Allways Environmental Services (Allways).

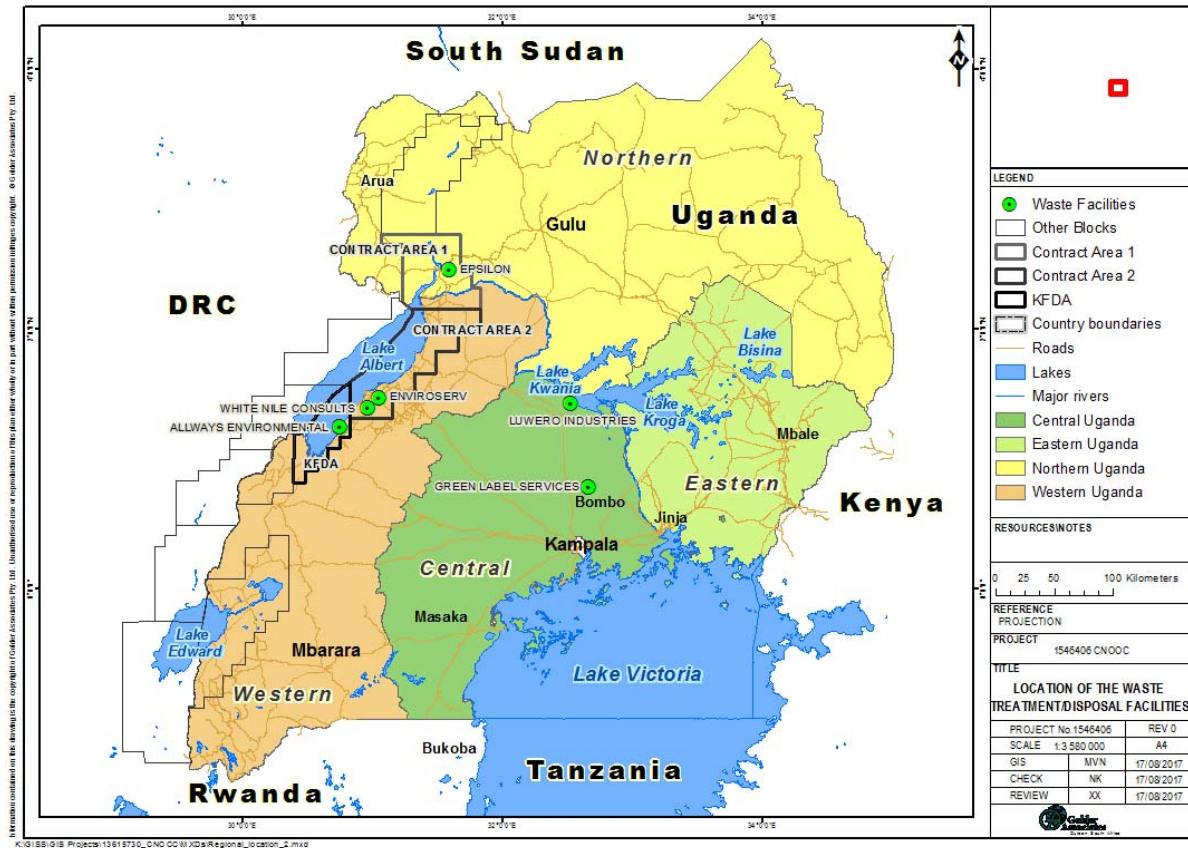

Figure 6: Location of Existing Treatment/Disposal Hazardous Waste Facilities

The following sections presents the current capacity of these treatment/disposal facilities to handle the main types of hazardous wastes including drill cutting, drilling fluids and associated hazardous wastes from the O&G sector.

It is understood (from workshops held in mid-May with hazardous waste management companies including treatment and landfill disposal companies) that once the Lake Albert oil fields area moves from the exploration and appraisal phases to the construction and production phases of field development, that Ugandan waste management companies will invest in the additional infrastructure and facilities. These waste facilities include those required to appropriately recycle, treat and dispose the waste types to the various waste managed facilities in Uganda to accommodate any current shortfall in current capacity to deal with the waste types anticipated. This will not only include those currently involved in hazardous waste management but also the larger domestic waste companies that are interested in entering the hazardous waste management sector.

3.3.1.2.1 Drilling Cuttings

Currently the drill cuttings are treated in two ways, namely biodegradation and landfilling.





Biodegradation

Biodegradation is the use of microorganisms (bacteria and fungi) to biologically degrade hydrocarbon contaminated waste into a non-toxic, beneficial product. There one existing biodegradation facility and one under construction. These facilities are owned/operated by the following two waste companies:

- 2) White Nile Consultants Ltd (White Nile); and
- 3) Allways Environmental Services (Allways).

Figure 7 below presents an overview of the biodegradation process used to treat drill cuttings from the E&A phase. This process comprises three main steps; pre-processing, biodegradation and preparation for disposal. In the pre-processing step involves screening and crushing. The drilling waste is offloaded into a temporary storage bund. From the storage bund the waste is put through a screen to remove non-biodegradable materials, such as plastics. The unwanted materials are then collected in a container for disposal at another facility. If required, the drill cuttings are passed through a crusher to break the material into more manageable pieces. The screened waste is then transferred to the biodegradation platform where it is mixed with blending material (to increase porosity and aeration) and culturing microbes (to speed up the biological processes). The leachate from the platform is collected and treated together with the drilling fluids in the liquid treatment plant (see section 3.3.1.2.2). The biodegradation platform is continuously monitored to ensure optimum conditions are present. The aggregate material is then cured to improve its condition and tested to ensure that it is safe. A relatively small percentage of the aggregate product is currently used for brick making, while the bulk of the material is landfilled.

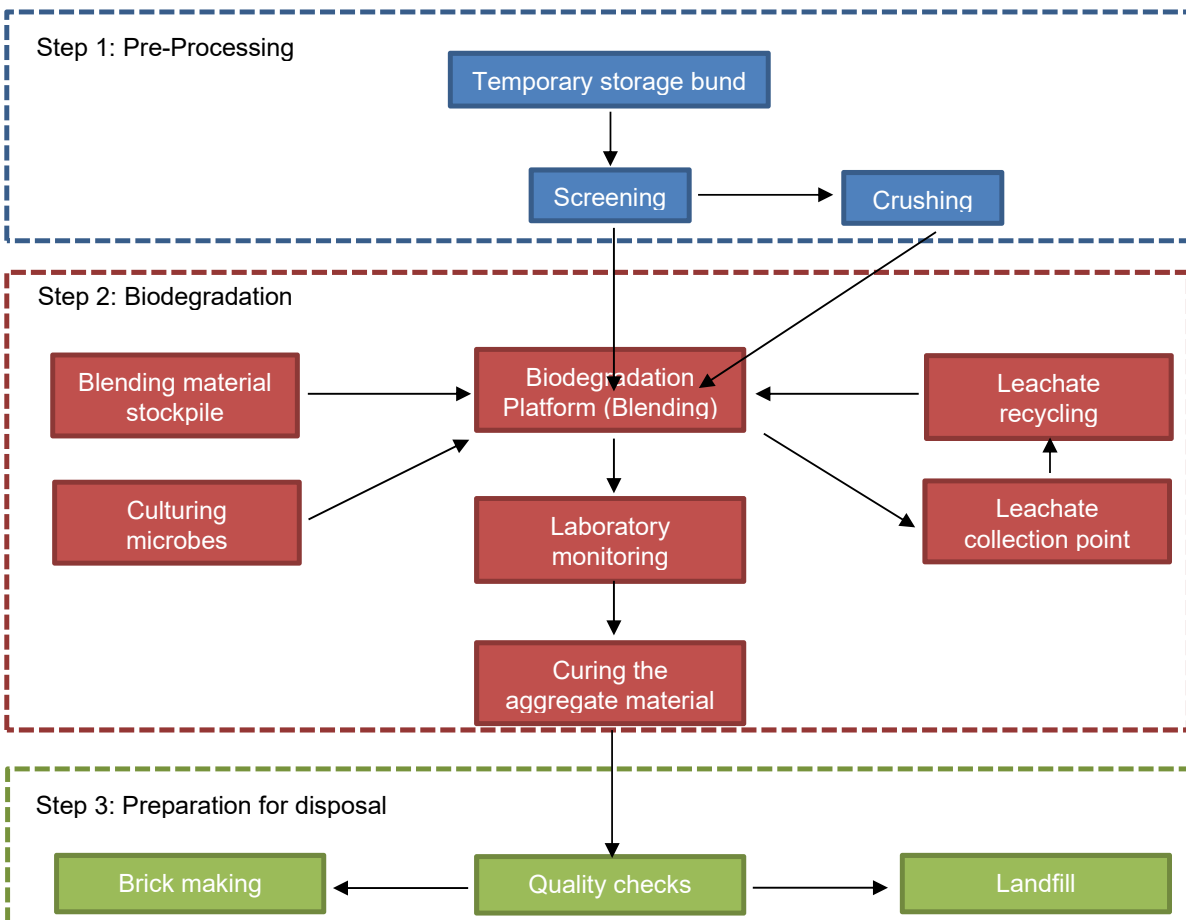

Figure 7: Flowchart of the Biodegradation Process



Table 14 below presents a summary of the key characteristics of the two biodegradation facilities (existing and under construction).

Table 14: Key Characteristics of the Existing Biodegradation Facility

Technology	Company	Year commissioned	Total Design capacity (t/yr)	Capacity used (t/yr)	Remaining capacity (t/yr)
Biodegradation	White Nile Consultants Ltd	2015	50 000	0	50 000
Biodegradation	Allways Environmental Services	Under construction	7 000	0	7 000
TOTAL			57 000	0	57 000

The current biodegradation process may require some modifications to extract heavy metals should they exceed acceptable levels for normal biodegradation. There are many options to extract heavy metals from drill cuttings, such as the use of acids, but this is dependent on the types and concentrations of heavy metals, and cost considerations. A number of companies now offering specialised products and services in this regard (e.g. Dispersion by Chemical Reduction). The most appropriate option is however dependent on a number of factors (e.g. types, concentrations, and state of heavy metals, cost of technology etc.), which would require detailed investigations.

Landfilling

There are currently three landfill sites used for the disposal of hazardous waste, and one under construction. These sites are owned/operated by:

- EnviroServ Uganda Ltd (EnviroServ);
- Luwero Industries Ltd (Luwero) - see Figure 8;
- White Nile Consultants Ltd (White Nile); and
- Allways Environmental Services (Allways).



Figure 8: One of the Open Cells at the Luwero Landfill Site



A summary of the key characteristics of the hazardous waste landfill sites is presented in Table 15 below. It can be seen that the remaining capacity of these landfill sites is 1 031 200 m³. Note however that this does not take into account the free land available for the future expansion at the Luwero and White Nile facilities.

Table 15: Key Characteristics of the Hazardous Waste Landfill Sites

Design standard	Company	Year commissioned	Total Design capacity (m ³)	Capacity used (m ³)	Remaining capacity (m ³)
H:H/Class A (South African)	EnviroServ Uganda Ltd	2014	1 000 000	20 000	980 000
Unknown	Luwero Industries Ltd	1999	50 000 (Free land available for future expansion)	25 000	25 000
H:H/Class A (South African)	White Nile Consultants Ltd	2015	15 000 (Free land available for future expansion)	TBC	15 000
Basel Convention Technical Guidelines on Specially Engineered Landfill (D5) /	Allways Environmental Services	Under construction	11 200	0	11 200
Total			1 076 200	45 000	1 031 200

It can be seen that two of the existing facilities have been designed in accordance with the South African engineering requirements for a Class A landfill site (i.e. high risk level wastes that have a high potential to contaminate the environment). Figure 9 below presents the minimum engineering design requirements for this type of landfill (GN R. 636 National Norms and Standards for Disposal of Waste to Landfill, 23 August 2013).



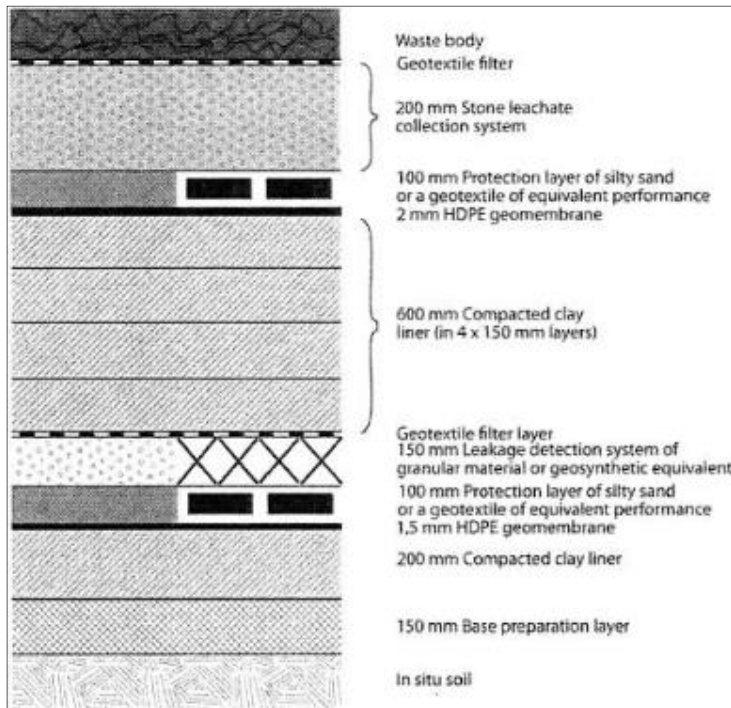

Figure 9: Minimum Engineering Design Requirements for Class A Landfill Site (South Africa, GN R. 636 norms and standards)

3.3.1.2.2 Drilling Fluids

There are currently two facilities used to treat drilling fluids from E&A phase, and are capable of treating drilling fluids from the C&P phases. These facilities are owned/operated by:

- EnviroServ Uganda Ltd (EnviroServ) - see Figure 10; and
- White Nile Consultants Ltd (White Nile).

It is our understanding that Luwero Industries Ltd also has a treatment plant, but there is currently no proposal to use this plant for the treatment of drilling fluids.



Figure 10: Leachate Treatment Plant at EnviroServ



A summary of the key characteristics of the two liquid hazardous waste treatment facilities is presented in Table 16 below. At present, these facilities are predominately used to treat leachate from the landfill sites and therefore have sufficient capacity to treat approximately 82 500 kilolitres of drilling fluids per annum. It is our understanding that the facility using ultrafiltration and reverse osmosis has been designed to be modular, and could be expanded if required.

Table 16: Key characteristics of the drilling fluids treatment facilities

Technology	Company	Year commissioned	Total Design capacity (kℓ/yr)	Capacity used (kℓ/yr)	Remaining capacity (kℓ/yr)
Ultrafiltration & reverse osmosis	EnviroServ Uganda Ltd	2014	36 500	0	36 500
Flocculation & coagulation	White Nile Consultants Ltd	2015	48 000	2 000	46 000
Total					82 500

The EnviroServ treatment facility was designed to treat drilling fluids, contaminated stormwater and leachate from their landfill to river discharge standards (Malan, 2016). In selecting the appropriate technology, a number of options were evaluated, as shown in Table 17.

Table 17: Comparison of treatment technologies (adapted from Malan, 2013)

Technology	TDS treatment	COD treatment	Capital expenditure	Operating expenditure	River discharge standards
Chemical treatment	X	✓	Low	Medium	X
Biological treatment	X	✓	Medium	Medium	X
Evaporation	✓	✓	High	High	✓
Freeze crystallisation	✓	✓	High	Medium	✓
Membranes	✓	✓	Medium	Medium	✓
Ion exchange	✓	X	High	High	X
Natural processes	X	✓	Medium	Low	X

Membrane technology, comprising ceramic ultrafiltration and reverse osmosis, was ultimately selected for the following reasons:

- It would be able to meet the requirements in terms of total dissolved solids (TDS), chemical oxygen demand (COD), and river discharge standards;
- The technology is relatively robust;
- Capital and operating costs are not as high as the other technologies; and
- Local expertise is available.

Table 18 shows that the discharge from the treatment plant meets the required river discharge standards.

Table 18: Treated Effluent Discharges in comparison to the River Discharge Standards (adapted from Malan, 2013)





Parameter	Units	Feed	Stage 1: pH correction and solids precipitation	Stage 2: Ceramic ultrafiltration	Stage 3: Single pass reverse osmosis	River discharge standards
pH		10.05	9.96	9.95	7.47	6 – 8
Conductivity	mS/cm	23.20	22.7	22.7	0.347	1.8
TDS	mg/l	48 730	44 428	30 879	58	1 200
COD	mg/l	71 233	69 260	56 033	-	-
Alkalinity	mg/l	0.627	0.596	0.485	0.543	500

Similarly, the White Nile treatment facility was also designed to treat drilling fluids, contaminated stormwater, and leachate from the biodegradation platform and their landfill site to Ugandan river discharge standards.

Figure 7 below presents an overview of the treatment process used to treat drilling fluids and other hazardous liquid waste at the White Nile facility. This process comprises three main steps; liquid separation, de-watering, and de-oiling.

In the first step, the liquid waste is discharged into the liquid waste storage pit. The waste is then pumped to the shale shaker which separates cuttings and other large solids from the liquid waste. If these cuttings and other large solids are covered in mud, the dryer can be used to recover the excess moisture, returning it to the buffer tank. The centrifuge removes the finer solids from the liquid waste.

In the second step, a gel breaker, organic flocculants, and inorganic flocculants are added to the liquid waste in the mixing tank, causing the flocculation of the finer solids which can then be removed by the centrifuge.

In the final step, a coagulant is added to the floating oil removal tank, to separate the oils from the liquid waste. The treated liquid waste is then tested to ensure that it meets river discharge standards. Currently, the treated liquid waste is used onsite in the biodegradation process.



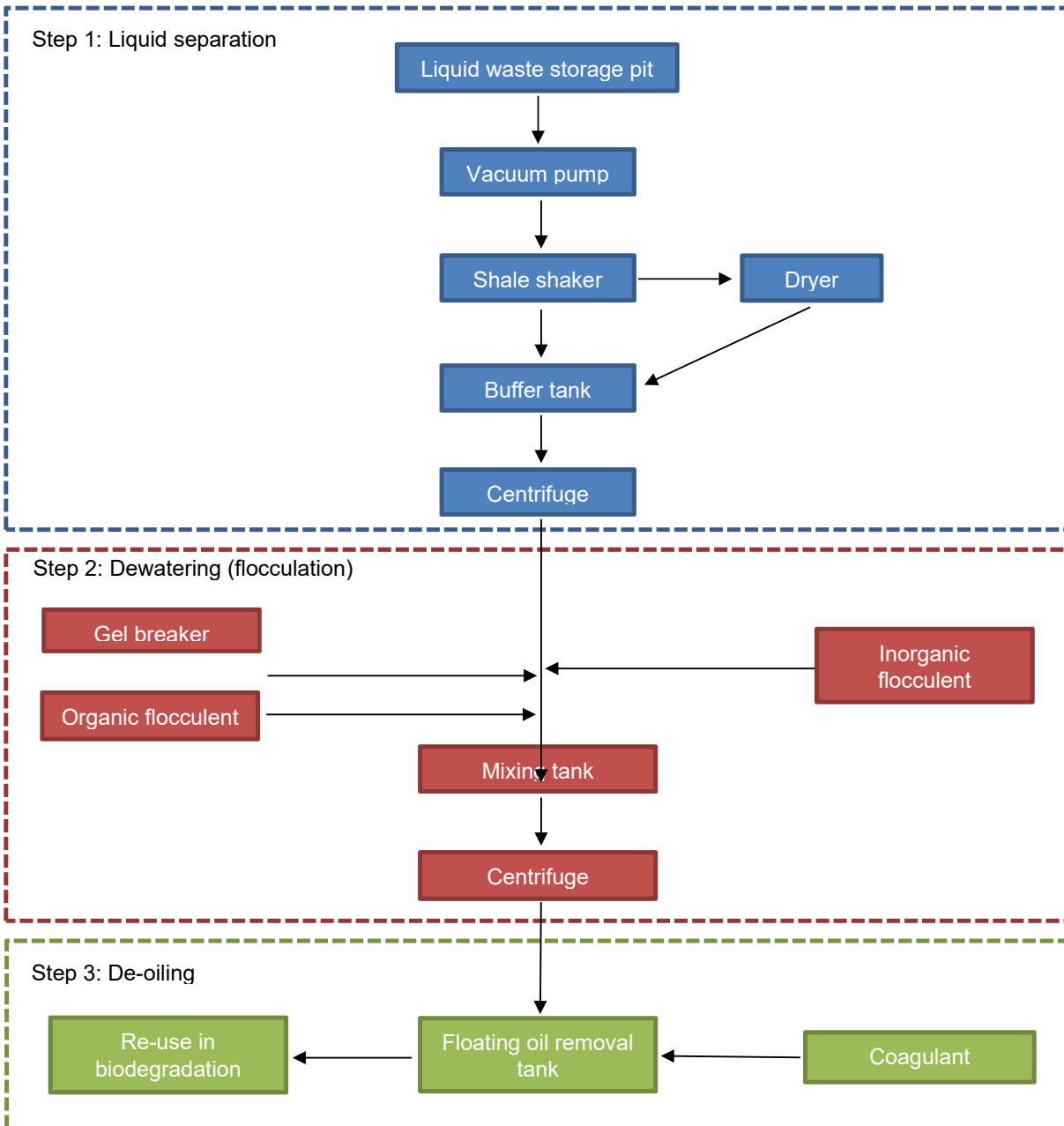

Figure 11: Flowchart of the Liquid Hazardous Waste Treatment Process

Both flocculation-coagulation and ultrafiltration-reverse osmosis are accepted as international best practice technologies for the treatment of drilling fluids. However, due to the complexity of the composition of WBDs and in particular NADFs, it is very difficult to formulate general recommendations. Further to this, each of the technologies offers advantages and disadvantages, with no single technology addressing all facets of the problem.

As a result of the drawbacks of individual treatment technologies, and more stringent discharge standards, a trend is emerging of using a combination of treatment technologies. In this context, the suitable treatment technology (or combination of technologies) is dependent on its ability to meet Ugandan river discharge standards.





3.3.1.2.3 Associated Hazardous Wastes

In addition to drill cuttings and drilling fluids, other types of hazardous waste associated with drilling operations are also generated by the O&G sector. This includes for example, oily filters and rags, chemicals residue, and medical waste (see section 3.1.2.3).

There are currently three facilities licenced to treat associated hazardous wastes. These facilities are owned/operated by:

- Epsilon (U) Ltd (Epsilon);
Green Label Services Ltd (Green Label); and
Luwero Industries Ltd (Luwero).

While incineration is accepted as an option for the treatment of drill cuttings and drilling fluids, it is generally not recommended as there is no recovery of oil and/or due to the energy-intensity of the process.

A summary of the key characteristics of the three facilities for the treatment of associated hazardous wastes is presented in Table 19 below. These facilities, which are predominately used to treat medical and chemical wastes, have approximately 4 484 tonnes spare capacity per annum.

Table 19: Key Characteristics of the General Hazardous Waste Treatment Facilities

Table with 6 columns: Technology, Company, Year commissioned, Total Design capacity (t/yr), Capacity used (t/yr), Remaining capacity (t/yr). Rows include Dual-chamber pyrolytic incinerator, Multiple chamber incinerator, Dual-chamber rotary kiln, and a TOTAL row.

All three facilities use incineration technology to treat general hazardous waste. Incineration is essentially a high temperature (200 °C to 1 000 °C+), dry oxidation process that reduces organic and combustible waste to inorganic, incombustible matter, resulting in a reduction in waste volume and weight (Chartier et al. 2014).

These facilities currently use three incinerator technologies, namely a multiple chamber incinerator, dual-chamber rotary kiln, and dual-chamber pyrolytic incinerator.

Multiple Chamber Incinerators

Multiple chamber incinerators, such as the one depicted in Figure 12 were more common in the past. This technology has however been phased out in many countries due to their high volumes of airborne emissions.

These incinerators are typically rectangular in design and have a large primary chamber with a moving grate, as well as a secondary chamber to burn off volatile organic compounds in the flue gas. The incinerators

14 Based on design capacity of 4 tonnes / week for 52 weeks.
15 Based on design capacity of 1 tonne / hour for 24 hours per day for 365 days.
16 Based on design capacity of 500 kg per hour for 24 hours per day for 365 days.





operate in the excess-air mode and use supplementary fuel to reach temperatures of around 800°C to 1 000°C.

Multiple chamber incinerators are typically used to treat infectious waste (e.g. sharps), chemical and pharmaceutical wastes, and general health care waste. These types of incinerators should however not be used to incinerate pressurised containers, halogenated plastics (e.g. PVC), and wastes with high content of heavy metals (e.g. thermometers, batteries).



Figure 12: Multiple chamber Incinerator at Green Label's Facility (www.greenlabelservices.com)

Internationally, the use of multiple-chamber incinerators has been decreasing in recent years due to increasingly stringent air emissions standards. While there are a number of flue-gas treatment technologies available to reduce the concentration of pollutants, the cost of these options can be prohibitive. This includes the following technologies¹⁷:

- Scrubber systems are used to reduce the acid components (e.g. CL, S) in the flue-gases;
- Electrostatic Precipitators (ESPs) are used to decrease the amount of heavy metals in the flue gases;
- Bag-house filters are used to reduce the amount of dust in the flue gases; and
- Activated carbon or Selective Catalytic Reduction (SCR) are used to reduce the release of dioxins to the air.

Dual-Chamber Rotary Kiln

Dual-chamber rotary kilns, such as the one depicted in Figure 13 are essentially a rotating oven with a post-combustion chamber. They are specifically designed to burn chemical wastes, but are also suitable for infectious waste (e.g. sharps) and pharmaceutical wastes, and general health care waste.

As with multiple chamber incinerators, pressurised containers, radioactive waste, and wastes with high content of heavy metals (e.g. thermometers, batteries) should not be incinerated. Incineration temperature is typically between 950°C and 1 300°C.

¹⁷ European Union (2006), Reference Document on the Best Available Techniques for Waste Incineration,



Figure 13: Dual-chamber Rotary Kiln under Construction at Luwero's Facility

Dual-Chamber Pyrolytic Incineration

Pyrolytic incineration (also known as controlled air incineration) is reliable and the most commonly used treatment process for industrial hazardous waste and health care risk waste (Chartier *et al.* 2014). It comprises a pyrolytic chamber and a post-combustion chamber. In the pyrolytic chamber, the waste is thermally decomposed through an oxygen-deficient, medium-temperature combustion process (800 °C to 900 °C), producing solid ashes and gases. In the post-combustion chamber, the gases are burned at high temperature (900 °C to 1 200 °C) by a fuel burner using an excess of air to minimise smoke and odours.

As mentioned previously, these facilities are all located outside of urban centres due to the nature of the activities. The facilities are typically situated in sparsely populated areas and far from sensitive receptors, such as residences.

In general, the sites are relatively large (10 ha - 40 ha), with only a small portion of the site actually used for the treatment/disposal of waste. Site ownership is typically freehold, with only one facility leasing the site from the land owner. The facilities are all fenced, with manned access control.

All the facilities have established community forums to engage with the surrounding local community, keeping them updated and addressing any complaints. These forums typically convene on a monthly basis.

The incinerators mainly accept medical waste, chemicals, and other types of general hazardous waste. Prohibited types of waste include electronic and radioactive wastes.

Some of the facilities have or are considering implementing recycling operations on site. For example, the one facility is permitted to use 100 tonnes of treated drill cuttings to manufacture bricks. These bricks are however only permitted to be used on site. Another facility is in the process of investigating technologies for the recovery of oils and solvents from the waste. Another facility is recycling plastic onsite.



4.0 WASTE INVENTORY FROM KDA PROJECT PHASES

The KDA project will involve three main phases: a preparation (design) phase, a construction and drilling phase and an operational phase. Each phase will generate wastes. This section of the report will discuss the wastes generated at these phases as follows:

- Drilling Phase Wastes (WBDMs and NADFs);
- Construction and Operational Phase Wastes; and
- Decommissioning Phase Wastes.

4.1 Drilling Phase Wastes

The KDA project is expected to consist of 20 production wells (producers) and 11 water injection wells (injectors) drilled from four well pads on the eastern shores of Lake Albert. The bulk of the waste generated on a well pads will consist of drilling cuttings and clear liquids. Figure 14 provides a drilling circuit process that shows the two main waste streams (cuttings and clear liquids).

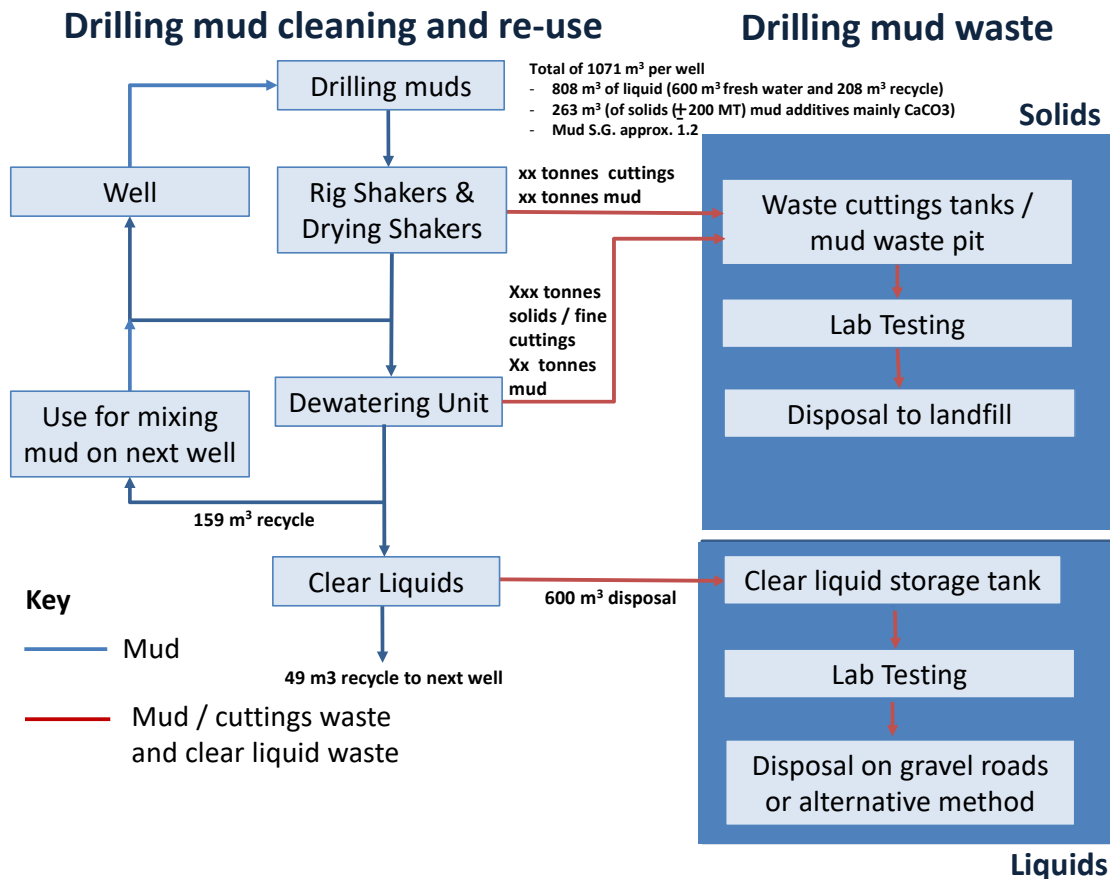

Figure 14: Process for the Generation of Drilling Waste

Table 20 describes the waste streams, estimated quantities and disposal options for drilling and other wastes from the well pad during the drilling of wells. The bulk of the waste generated on the well pads will consist of drilling cuttings and clear liquids. While there will be some variability between the wells, and the quantity of drilling waste will depend on final decisions about dewatering equipment, typical cuttings volumes will be in the order of 600 m³/well, with one third water based mud cuttings and the balance synthetic mud





cuttings. Liquids for disposal are expected to be in the order of 1,000 m³ per well, dependent on how much is evaporated from the evaporation ponds.

Further details about the BPEO for the waste management during the project phases is provided in Sections 5.0 and 5.2.2.

Table 20: Wastes generated on the KDA well pads during the drilling phase

Waste Stream	Estimated quantity (total per well)	BPEO for Waste Management
Hazardous Solids (used chemical containers, fuel storage containers, oil-contaminated rags, used batteries, used filters, fluorescent tubes, power unit/transport maintenance wastes, paint waste,)	0.1 t (minimal)	Options include recovery / recycling, disposal (with or without pre-treatment) to an appropriately licensed landfill to receive hazardous waste.
Hazardous solids (potentially contaminated cement slurry)	4 t	Disposed to landfill licensed to receive hazardous waste.
Hazardous Liquids (used oil, waste chemicals, rinsate, thinners, viscofiers, solvents, acids, treating chemicals, other used chemicals in drums)	0.07 t	Options include recovery / recycling, disposal (with or without pre-treatment) to landfill licensed to receive hazardous waste.
Non Hazardous Liquids (sewage effluent, grey water)	N/A	Conservancy tanks. Domestic effluent removed by tanker to the sewage treatment plant at the drilling camp. Unmanned wellpad, portable sewage tank and treatment unit to be provided during drilling (Ref. 35).
Non Hazardous Solids (construction materials, packaging wastes, paper, scrap metal, plastics, glass)	66 - 96 t (Ref.35)	Waste minimization, separation, re-use and recycling where possible. Domestic refuse disposed to landfill licensed to receive non-hazardous domestic waste.
Drilling Cuttings (solids), coarse and fine particles - aqueous (water based)	205 m ³	Separation from drilling fluids in varying degrees, depending on dewatering equipment installed on the well pad. Disposal to landfill licensed to receive the waste by a certified waste contractor. Landfill site options to be assessed in the ESIA. Landfills include: <ul style="list-style-type: none"> ▪ Enviroserv Uganda Ltd. ▪ White Nile Consultants Ltd; and. ▪ Allways
Drilling Cuttings (solids), coarse and fine particles - synthetic	422 m ³	Biodegradation or as above.
Drilling Liquids (including clear liquids from dewatering of aqueous drill cuttings)	500 m ³	Recycled as much as possible. May also be reduced by evaporation ponds. Ultrafiltration-Reverse Osmosis / Flocculation-Coagulation. The final disposal option is by disposal to landfill licensed to receive the waste. Quantity will depend on extent of evaporation in evaporation ponds. Landfill site options to be assessed in the ESIA (see above).
Completion Fluids (solids, residual drilling fluids, hydrocarbons, acids, glycol, methanol, other)	TBC	Ultrafiltration-Reverse Osmosis / Flocculation-Coagulation. Pre-treatment and/or disposal to landfill licensed to receive the waste. Preferred landfill site to be determined by the ESIA (see above).





Calculation based on

Quantities provided in the table above are estimated and will depend on a number of factors, including the extent to which dewatering equipment is used on site and liquids are recycled. A rule of thumb is that roughly 0.5 m³ of drilling mud is generated per metre of well drilled.

Drilling is anticipated to take approximately 5 years, over which time approximately 31 wells from four well pads will be drilled (see Figure 15)

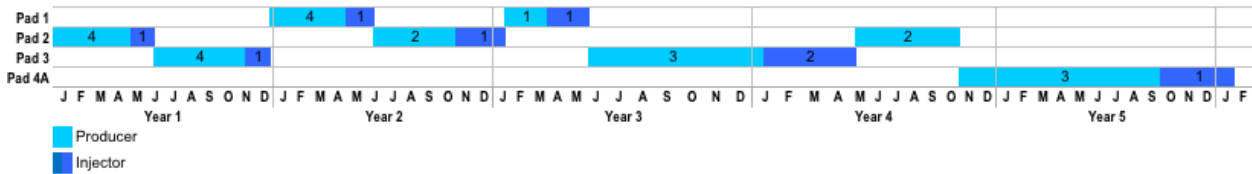

Figure 15: Schedule of drilling of Producer and Injector wells

Most of the waste streams that will be generated cannot be pre-classified. Only once the wastes have been generated may they be sent for analytical testing to determine their classification. It is understood that the drilling wastes from various wells in Uganda have been found to contain substances capable of polluting the environment, mainly traces of heavy metals in addition to residual hydrocarbons. There are no specific Ugandan Standards for solid waste disposal. The drilling wastes from the drilling wells will be dealt with in the same manner, i.e. as capable of polluting the environment due to heavy metals and hydrocarbons, until they may be sent for appropriate testing to determine their classification

4.2 Construction Phase Wastes

Various types of materials and equipment associated with the construction industry will be imported to the KDA for the roads, CPF, upgrade of existing facilities and camps during the project construction phase. The construction of Project infrastructure will be completed prior to the commencement of drilling.

The construction phase will involve the following general activities:

- Clearing, levelling and terracing;
- Foundations and civil construction works;
- Installation of Equipment;
- Electrical and other tie ins;
- Commissioning and testing of plant and equipment.

Areas will be cleared of overgrowth and the soil leveled, which are minimal and excavated as required for the construction of project infrastructure. The excavated materials, mostly soil is not regarded as waste and will be stored at strategic areas. Some of this material will be used for backfilling and the rest will be used for landscaping and future rehabilitation purposes.

Construction solid waste is calculated based on the building area or structure volume multiplied by a factor of expected waste tonnage (0.05 and 0.03 respectively for area and volume); as such it is expected to be about 1,530 to 1,720 tons from the CPF, permanent and temporary camps, supply base, safety check station, lake water intake pump station, and infield lines (Ref. 35).

Non Hazardous Waste

Non-hazardous waste will be collected, bagged and transported back to the camp for sorting, recycling and disposal. Non-hazardous waste includes plastic, scrap metal, wood, lunch cartons, water bottles, packaging and other incidental waste. It is expected that 2 kg of domestic non-hazardous waste will be generated per person per day (Ref. 35).





Sufficient provision for staff ablutions will be provided by ventilated chemical toilets generating sanitation sewage waste water. Based on previous waste characterisations done in the KDA, it is expected that the relative composition of the different non-hazardous solid wastes generated in the Lake Albert Oilfield will be as shown in Table 6.

A maximum of 300 m³ per day of domestic sewage waste from 800 people from accommodation and the office areas is expected to be generated from the temporary camp (Ref. 35).

Hazardous Waste

Hazardous waste generation is generally limited to waste oil and grease from vehicle maintenance, which will be undertaken at the Kingfisher camp site. Table 4 shows the anticipated composition and quantity of hazardous waste generated during construction of the CPF.

Table 4: Expected Hazardous Solid Wastes generated during Construction of the CPF (34 months)

Waste Type	Main Source	Possible Environmentally Significant Constituents	Mass (tonnes)
Empty chemical drums, drum rinsate and containers	Metal, glass, plastic containers	Heavy hydrocarbons, solvents	117 t
Cement slurries	Cement slurries	Heavy metals, thinners, viscosifiers, pH, salts	3,679 t
Paint materials	Paints, thinners, coatings	Heavy metals, solvent, hydrocarbon	4.2 t
Maintenance wastes	Sandblast (grits), greases, fuel oils, filters	Heavy metals, hydrocarbons, solids, solvents	3.4 t
Industrial waste	Batteries, transformers, capacitors	Acid, alkali, heavy metals, PCBs	1.4 t
Scrap metals	Used piping, cables, drums, casing etc.	Heavy metals, scales	7.1 t

The proposed KDA project is situated in a remote area where few suitably licensed waste management facilities for waste disposal are available. General and hazardous waste generated during the construction of KDA project infrastructure will not be mixed, but stored separately (in a fashion as to mitigate against potential pollution) on the site before removal by a private contractor for disposal at approved waste facilities. Waste will be recycled as far as possible to give effect to the waste management hierarchy.

Road upgrade and construction in the KDA, along with associated extraction of rock from the borrow pits and crushing at the crushing plant will be completed prior to the commencement of the Project and were considered in the road ESIA. These activities have therefore been excluded from this assessment.

4.3 Operational Phase Wastes

Operations at the CPF have been assumed to commence immediately following completion of the infrastructure construction, in order to process product from reactivated exploration wells. The production stage is anticipated to be approximately 25 years lifespan.

The CPF is designed for a throughput of 120,000 barrels of well fluid per day. The CPF will comprise the following items of fixed plant and assemblages of plant:

- Oil Separation Flash Gas facilities;
- Gas Treatment & Compression facilities;





- Produced Water Treatment & Injection facilities;
- Oil Storage & Export facilities;
- Ground flare;
- Power Generation plant;
- Electrical substation;
- Water treatment plant;
- Fire water and pumps;
- Plant Utilities area;
- Control room and administrative buildings;
- Maintenance workshop;
- Gatehouse; and
- Perimeter fencing, lighting and internal access road system.

The four production well pads will comprise the following items of fixed plant:

- Production well heads and manifolds;
- Water injection wells and manifolds;
- Utility Systems;
- Production and test flow meters;
- Pig Launcher/Receiver;
- Chemical injection system;
- Closed drain system; and
- Equipment room to accommodate instrumentation, telecom, and electrical equipment etc.

Non-Hazardous Waste

A description of typical non-hazardous wastes and their quantities expected at the CPF including wastes from the permanent camp is provided in the table below.

Table 21: Non-Hazardous waste from the CPF during the Operational Phase

Waste Type	Activity (Source)	Mass per year (t)	Recycling / Disposal
Plastic	Bottles, waste packings	1,560	Mostly recycled
Paper / packaging	Packaging, office paper waste		Recycled
Wood	Packaging		Recycled
Rubber	Vehicle tyres		Recycled
Glass	Bottles		Recycled
Food and vegetable waste	Kitchens		Composted
Metal	Cold drink cans, processed food, other non-hazardous products, electrical metal scrap		Steel disposed to landfill. Aluminium recycled. Copper recycled





Waste Type	Activity (Source)	Mass per year (t)	Recycling / Disposal
Miscellaneous	General office and personnel camp scrap		Disposed to landfill

*Calculation based on 2 kg of waste/person/day for 120 people at the CPF over 25 years (0.002 x 120 x 5 days x 52 weeks x 25 years).

The following maximum amounts of domestic sewage waste are expected during the operational phase (Ref. 35):

- 30 m³ per day from 120 people working in the CPF and office areas;
- 40 m³ per day from 135 people from accommodation and the training office areas from the permanent camp;
- 5 m³ per day from 20 people from the supply base; and
- 2.5 m³ per day from 10 people from the safety check station.

Hazardous Waste

A description of typical wastes and their quantities expected at the CPF is included Table 22.

Table 22: Hazardous production wastes generated at the CPF during the operational phase

Waste Type	Activity / Source	Potential Contaminants	Mass per year (t)
Contaminated soil/hydrocarbon bearing soil	Spill/leaks	Hydrocarbons, heavy metals, salts, treating chemicals	5 t
Pigging sludge	Pipeline cleaning operations	Hydrocarbons, solids, production chemicals, phenols, aromatics	10 t
Waste oil sludge (from produced water treatment)	Produced water treatment system	Hydrocarbons	200 t
Produced sand	Removal from well fluids	Hydrocarbons	145 t
Pipe scale, hydrocarbon solids, hydrates, and other deposits	Cleaning piping and equipment	Hydrocarbons, heavy metals	20 t
Solid wastes generated by crude oil and tank bottom reclaimers	Separation tank sediments	Hydrocarbons, solids, production chemicals, phenols, aromatics	5 t
Empty chemical drums, drum rinsate and containers	Chemical injection, water treatment, cleaning agents	Heavy hydrocarbons, solvent	65 t
Cement slurries	Cement slurries	Heavy metals, thinners, viscosifiers, pH, salts	5 t
Paint materials	Unused paints, used thinners	Heavy metals, solvent, hydrocarbons	0.5 t
Maintenance wastes	Sandblast (grits), greases, fuel oils, filters, paint scale	Heavy metals, hydrocarbons, solids, solvents	5 t
Industrial waste	Batteries, transformers, Capacitors	Acid, alkali, heavy metals, PCBs	3 t





Scrap metals	Used piping, cables, drums, casing etc.	Heavy metals, scales	2 t
Sewage sludge	Domestic water treatment	Pathogens	137.5 m ³ *

*Calculation based on quantities given in section above (77.5 days x 5 days x 52 weeks x 3 years)

Most of the waste streams that will be generated cannot be pre-classified. Only once the wastes have been generated may they be sent for analytical testing to determine the classification and final treatment and/or disposal.

4.4 Decommissioning Phase Wastes

Decommissioning activities are anticipated to comprise dismantling, decontamination and removal of process equipment and facility structures and remediation activities. The following works have been identified for this stage of the Project:

- Removal of production/injection wells and well pads;
- Excavation and removal of field flow lines;
- Decommissioning, demolition and removal of CPF;
- Demolition and removal of accommodation; and
- Removal of other infrastructure.

The decommissioning phase is anticipated to include activities and plant items similar to those used in the construction phase. If the Project infrastructure cannot be utilised for any alternative purposes, buildings, materials and all other infrastructure related equipment will be dismantled and recycled as far as possible. Buildings will be demolished and the building rubble either recycled if possible or disposed of in an environmentally friendly manner, possibly as part of the land levelling.

Decommissioning solid waste is calculated based on the building area or structure volume multiplied by a factor of expected waste tonnage (1.3 and 1.6 respectively for area and volume); as such it is expected to be about 39,790 to 91,800 tons from the CPF, permanent and temporary camps, supply base, safety check station, lake water intake pump station, and infield lines (Ref. 35).

A maximum of 40 m³ per day of domestic sewage waste from 135 people from accommodation and the training office areas is expected to be generated from the permanent camp during the decommissioning phase (Ref. 35).

5.0 WASTE MANAGEMENT FOR THE KDA PROJECT

5.1 The Waste Management Hierarchy

One of the key principles of waste management is the application of the waste hierarchy (E&P Forum, 1993), as shown in Figure 16. Furthermore, there is a Duty of Care for any producer that discards waste, to ensure that there is no harm to the environment or human health, and that the waste is suitably handled by licensed waste transporters and treatment/disposal companies from cradle to grave.



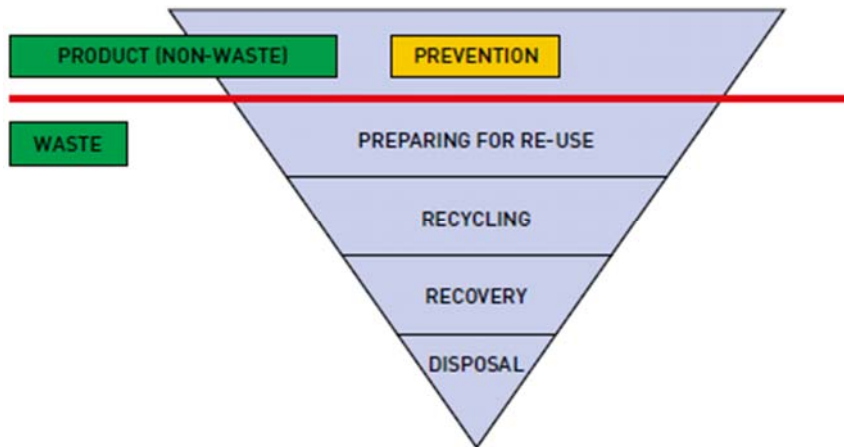

Figure 16: The Waste Management Hierarchy (Ref. 29)

In the context of this study, responsible waste management can be accomplished through hierarchal application of the practices of source reduction, reuse, recycling, recovery, treatment and responsible disposal. This may include for example the following elements:

- Source reduction – the generation of less waste through efficient practices such as:
 - Waste minimisation or material elimination;
 - Inventory control and management;
 - Material substitution;
 - Process modification; and
 - Improved housekeeping.
- Reuse – the use of materials or products that are reusable in their original form such as:
 - Chemical containers;
 - Drilling fluids for road construction and stabilisation; and
 - Burning waste oil for energy.
- Recycling/recovery – the conversion of wastes into usable materials and/or extraction of energy or materials from wastes. Examples include:
 - Recycling drilling fluids;
 - Using cleaned drill cuttings for road construction material; and
 - Recovering oil from tank bottoms and produced water.
- Treatment – the destruction, detoxification, and/or neutralisation of residues through process such as:
 - Biological methods (e.g. land spreading/farming, biodegradation etc.);
 - Thermal methods (e.g. incineration, thermal desorption etc.);
 - Chemical methods (e.g. precipitation, extraction, neutralisation, stabilisation etc.); and
 - Physical methods (e.g. gravity separation, filtration, centrifugation etc.).



- Responsible disposal – depositing wastes on land or in water using methods appropriate for a given situation. Disposal methods include:
 - Landfilling;
 - Burial;
 - Surface discharge;
 - Land spreading or land farming; or
 - Underground injection.

5.2 Best Practice Waste Management for the KDA Project

5.2.1 Non-Hazardous Waste Management

Recommendations for the best available technologies (BAT) for each non-hazardous waste type are outlined in the table below taking into account the waste management hierarchy, as provided by the Atacama study done for the three O&G companies in the oil fields development area (study report dated July 2017, Ref. 30).

Table 23: Best Available Technology for Non-Hazardous Waste Types

Non-hazardous Solid Wastes	
<i>Food & Vegetative Wastes</i>	<ol style="list-style-type: none"> 1. Avoid, Reduce, Reuse, Source-segregate and collect all food wastes generated. Also source-segregate any hazardous waste from the food and vegetative wastes. 2. Preferentially treat all food, kitchen and vegetative wastes via Anaerobic Digestion using low cost, high-tech fabric. Where this is not possible, composting should be applied. 3. Use the digestate slurry from anaerobic digester for landscaping, or direct to the wastewater treatment plant. Direct the biogas generated from the anaerobic digester to the camp kitchen for use as a cooking fuel.
<i>Plastics</i>	<ol style="list-style-type: none"> 1. Avoid, Reduce, Reuse, Source-segregate and collect all plastic wastes generated. Also source-segregate any hazardous waste from the plastic wastes. 2. Recycle all the readily recyclable plastics. 3. Incinerate any residual plastics via a NEMA certified waste contractor, or dispose at a NEMA certified non-hazardous landfill if incineration is not possible.
<i>Paper</i>	<ol style="list-style-type: none"> 1. Avoid, Reduce, Reuse, Source-segregate and collect all paper wastes. Also source-segregate any hazardous waste from the paper wastes. 2. Recycle all the dry, non-blue paper. <p>Incinerate any residual wet or blue paper via a NEMA certified waste contractor or dispose at a NEMA certified non-hazardous landfill if incineration is not possible.</p>
<i>Metal</i>	<ol style="list-style-type: none"> 1. Avoid, Reduce, Reuse, Source-segregate and collect all metal wastes generated. Also source-segregate any hazardous waste from the metal wastes. 2. Recycle all the readily recyclable metal.
<i>Glass</i>	<ol style="list-style-type: none"> 1. Avoid, Reduce, Reuse, Source-segregate and collect all glass waste generated. Also source-segregate any hazardous wastes from the glass waste. 2. Dispose any residual glass waste at non-hazardous landfill.
<i>Rubber</i>	<ol style="list-style-type: none"> 1. Avoid, Reduce, Reuse, Source-segregate and collect all rubber waste generated. Also source-segregate any hazardous waste from the rubber wastes. 2. Incinerate any residual rubber waste via a NEMA certified waste contractor, or dispose at a NEMA certified non-hazardous landfill if incineration is not possible.





<i>Wood</i>	<ol style="list-style-type: none"> 1. Avoid, Reduce, Reuse, Source-segregate and collect all wood waste generated. Also source-segregate any hazardous waste from the wood wastes. 2. Recycle all the readily recyclable. 3. Incinerate any residual wood waste via a NEMA certified waste contractor, or dispose at a NEMA certified non-hazardous landfill if incineration is not possible.
<i>C&D wastes</i>	<ol style="list-style-type: none"> 1. Source-segregate any hazardous waste from the C&D wastes. 2. Recycle all the readily recyclable C&D waste. 3. Dispose any residual C&D waste at a NEMA certified non-hazardous landfill.
<i>Miscellaneous wastes (e.g. used insulation, used tyres, hoses, textiles)</i>	<ol style="list-style-type: none"> 1. Source-segregate any hazardous waste from the assorted wastes. 2. Reuse and Recycle any readily reusable/recyclable wastes. 3. Incinerate any residual incinerable wastes via a NEMA certified waste contractor, or dispose at a NEMA certified non-hazardous landfill if incineration is not possible.
Non-Hazardous Liquid Wastes	
<i>Grey Water</i>	<ol style="list-style-type: none"> 1. Avoid /Reduce. 2. Reuse/Recycle. 3. For the waste water that cannot be reused without prior treatment, treat via Physico-chemical and Biological Effluent Treatment Plant. Additionally, because currently, some of the facilities already have Physico-chemical Effluent Treatment Plants, it is advisable to develop a Constructed Wetland for further (tertiary) polishing of the effluent prior to reuse/recycle/disposal. 4. Use sludge generated from the treatment process in manure application if it meets manure requirements; if it does not meet requirements, treat at a waterworks facility via a NEMA certified waste contractor
<i>Boiler Blowdown Water</i>	<ol style="list-style-type: none"> 1. Avoid /Reduce. 2. Reuse/Recycle in the feed water tank. 3. If the water cannot be reused without treatment, treat via Physico-chemical and Biological Effluent Treatment Plant. 4. Dispose of sludge at a landfill via a NEMA certified waste contractor.
<i>Storm Water</i>	<ol style="list-style-type: none"> 1. Avoid /Reduce by using underground storage tanks as a rain water harvesting mechanism. 2. Any water that is not harvested should be directed into drainage outlets that connect to existing drainage networks

5.2.2 Hazardous Waste Management

In terms of waste management for wastes generated from oil fields, often the best practice environmental option (BPEO) internationally is not always the most practically feasibility option at a local level. The table below presents a summary list of the BPEO for handling of hazardous waste from the O&G sector from an international perspective, as well as the currently available facilities for O&G waste management in Uganda.

Table 24: International Industry BPEO and Currently Available BPEO in Uganda for O&G Wastes





Waste category	Waste type	International BPEO	Currently Available BPEO		
			Option 1	Option 2	Option 3
Drill cuttings		Biodegradation	Biodegradation ¹⁸	Cement Kiln ¹⁹	Landfill
Drilling fluids	WBDFs / NADF's	Ultrafiltration-Reverse Osmosis / Flocculation-Coagulation ²⁰	Ultrafiltration-Reverse Osmosis / Flocculation-Coagulation	-	-
Associated hazardous waste	Batteries (wet and dry)	Recycling (wet only)	Recycling (wet only)	Landfill (dry only)	-
	Chemicals residue	Return to manufacturer	Incineration	Landfill	-
	Completion and well work-over fluids	Ultrafiltration-Reverse Osmosis / Flocculation-Coagulation	Ultrafiltration-Reverse Osmosis / Flocculation-Coagulation	-	-
	Contaminated containers (e.g. oil drums)	Re-use of containers ²¹	Incineration	Landfill	-
	Contaminated hydrotest water	Ultrafiltration-Reverse Osmosis / Flocculation-Coagulation	Ultrafiltration-Reverse Osmosis / Flocculation-Coagulation	-	-
	Contaminated personal protective equipment (PPE)	Cement Kiln	Cement Kiln	Incineration	Landfill
	Contaminated scrap metal	Recycling ²²	Recycling	Landfill	-
	Electrical / electronic waste	Refurbishment / recycling	Landfill	-	-
	Foam	Ultrafiltration-Reverse Osmosis / Flocculation-Coagulation	Ultrafiltration-Reverse Osmosis / Flocculation-Coagulation	-	-
	Medical waste	Cement Kiln	Cement Kiln	Incineration	
	Oil contaminated soil	Biodegradation	Biodegradation	Cement Kiln	Landfill
	Oily rags, filters etc.	Cement Kiln	Cement Kiln	Incineration	Landfill
	Oily sludges (from the bottom of vessels)	Cement Kiln	Cement Kiln	Incineration	Landfill
Pigging wastes	Cement Kiln	Cement Kiln	Incineration	Landfill	

¹⁸ Modification of conventional biodegradation process may be required to extract or immobilize elevated levels of heavy metals in the treated materials. This may include for example, using acids, augmented bacteria, stabilization or Dispersal Chemical Reaction.

¹⁹ Subject to feasibility study and pilot project.

²⁰ Process changes may be required to adequately treat NADF's.

²¹ Requires cleaning to remove chemical and oily residues.

²² Requires cleaning to remove chemical or oily residues.





Waste category	Waste type	International BPEO	Currently Available BPEO		
			Option 1	Option 2	Option 3
	Paint residue (solid and liquid)	Return to manufacturer	Incineration	Landfill	-
	Pipe dope	Incineration	Incineration	Landfill	-
	Sewage	Sewage Treatment Plant	Sewage Treatment Plant	-	-
	Spent fluorescent tubes and lamps	Recycling	Landfill	-	-
	Spent welding rods, epoxy coatings, grinder wheels, visors, shot blast etc.	Landfill	Landfill	-	-
	Used aerosol cans;	Recycling	Landfill	-	-
	Used fabrication material (e.g. paint, cement, insulation);	Landfill	Landfill	-	-
	Used lubricating / hydraulic oil, grease, solvents and absorbent materials;	Solvent recovery / Central Processing Facility	Cement Kiln	Landfill	-

Table 25 provides the detail to the best waste management options (or BPEO) of the waste types generated at the KDA project phases by taking into account the waste management hierarchy approach as detailed in Section 5.1. In preparing this list of options, the following sources of information were used:

- BPEO for Drilling Wastes (Ref. 34);
- Drilling Waste Management Technology Review (Ref. 29); and
- Waste Management Guidelines (Ref. 33).

It should be noted that some options listed in these documents are not viable in this Ugandan project specific context; therefore, these 'no go' options have been excluded from the options analysis table below.





Table 25: Hazardous Waste Management Options

Waste hierarchy	Option	Locally Available	Waste category	Waste type	Description	Advantages	Disadvantages
Reduce	Source Reduction	Yes	All	All	<ul style="list-style-type: none"> Identify opportunities to eliminate materials, improve inventory control and management, substitute materials, modify processes and improve housekeeping. 	<ul style="list-style-type: none"> Offset costly treatment and disposal costs. 	<ul style="list-style-type: none"> Potential impact on processes.
Reuse	Reuse of Drilling Fluids	Yes	Drilling fluids	Drilling fluids	<ul style="list-style-type: none"> Reuse of drilling fluids in drilling operations; Water-based drilling fluids are typically only disposed of once drilling is completed; and Non-aqueous drilling fluids are typically reconditioned for reuse in other drilling operations. 	<ul style="list-style-type: none"> Standard practice in onshore/offshore drilling operations; Reduce volume of water required for drilling operations; and Reduce volume of waste requiring treatment/ disposal. 	<ul style="list-style-type: none"> Can impact on drilling operations.
Reuse	Refurbishment and Reuse of WEEE	No	Associated hazardous wastes	WEEE	<ul style="list-style-type: none"> Refurbishment and reuse of WEEE. 	<ul style="list-style-type: none"> Avoid disposal of WEEE which contains toxic heavy metals that poses a risk to the environment and human health; and In compliance with a number of international treaties and Ugandan legislation. 	<ul style="list-style-type: none"> Risk to workers refurbishing WEEE.
Reuse	Reuse of Chemical Containers	Yes	Associated hazardous wastes	Contaminated containers	<ul style="list-style-type: none"> Cleaning and reuse of contaminated containers. 	<ul style="list-style-type: none"> Offset costly treatment and disposal costs, and purchase of new containers. 	<ul style="list-style-type: none"> Generate wastewater from the cleaning of containers.
Recycling	Recycling at Cement Kiln	No	Drill cuttings Associated hazardous wastes	<ul style="list-style-type: none"> Drill cuttings; and Associated hazardous wastes 	<ul style="list-style-type: none"> Recycling of drill cuttings and associated hazardous wastes in a cement kiln. 	<ul style="list-style-type: none"> Partly replace the fuel that otherwise would have been needed to fire the kiln; Ash from waste can be mixed into the cement matrix, providing desirable source of aluminium, silica, clay, and other minerals; and Kiln may already be fitted with pollution control equipment. 	<ul style="list-style-type: none"> Air pollution; and Accumulation of non-organics (e.g. heavy metals) in the ash.
Recycling	Recycling of WEEE	No	Associated hazardous wastes	WEEE	<ul style="list-style-type: none"> Dismantling of WEEE to remove recyclable plastics, cabling and ferrous and non-ferrous metals. 	<ul style="list-style-type: none"> Avoid disposal of WEEE which contains toxic heavy metals that poses a risk to the environment and human health; Recovery of precious metals e.g. copper; and In compliance with a number of international treaties and Ugandan legislation. 	<ul style="list-style-type: none"> Risk to workers dismantling WEEE; and Risk to receiving environment with fugitive emissions and potentially contamination of water resources.
Recycling	Recycling of Wet-cell Batteries	Yes	Associated hazardous wastes	Wet-cell batteries	<ul style="list-style-type: none"> Dismantling of wet-cell batteries to remove recyclable plastics, and ferrous and non-ferrous metals. 	<ul style="list-style-type: none"> Avoid disposal of wet-cell batteries which contain acids and toxic heavy metals that pose a risk to the environment and human health. 	<ul style="list-style-type: none"> Risk to workers dismantling wet-cell batteries; and Risk to receiving environment with fugitive emissions and potentially contamination of water resources.





WASTE MANAGEMENT SPECIALIST ASSESSMENT

Waste hierarchy	Option	Locally Available	Waste category	Waste type	Description	Advantages	Disadvantages
Recycling	Recycling of Fluorescent Tubes and Lamps	No	Associated hazardous wastes	Fluorescent tubes and lamps	<ul style="list-style-type: none"> Dismantling of fluorescent tubes and lamps to recover glass, ferrous and non-ferrous metals, and mercury. 	<ul style="list-style-type: none"> Avoid disposal of fluorescent tube and lamps which contain mercury that poses a risk to the environment and human health. 	<ul style="list-style-type: none"> Risk to workers dismantling fluorescent tubes and lamps; and Risk to receiving environment with fugitive mercury vapour emissions and potentially mercury contamination of water resources.
Recycling	Recycling of Treated Cuttings for Construction Material	Yes	Drill cuttings	Drill cuttings	<ul style="list-style-type: none"> Use of treated cuttings for fill or cover materials, aggregate in concrete or brick processing, road pavements, bitumen or asphalt, or cement; and Cuttings typically require some form of pre-treatment to remove hydrocarbons and/or water/liquids. 	<ul style="list-style-type: none"> Can be used for hydrocarbon based cuttings; Less costly than incineration (i.e. rotary kiln); Avoid disposal of treated cuttings to land or on in a landfill; Avoid need to quarry/ mine for fill, aggregate, and so on; and Can be used on site, reducing need for transport of construction materials. 	<ul style="list-style-type: none"> Dependent on characteristics of the drill cuttings.
Recovery	Solvent extraction	No	Drilling fluids	Drilling fluids	<ul style="list-style-type: none"> Recovery of oils from drilling fluids using solvents, such as carbon dioxide, propane, hexane, trimethylamine or methyl chloride. 	<ul style="list-style-type: none"> Properly operated system will also allow for the recovery of oils, as well as the recycling/reuse of the solvents. 	<ul style="list-style-type: none"> Air quality and pollution impacts; and Risk to receiving environment with potential contamination of water resources.
Treatment	Incineration	Yes	Drill cuttings Drilling fluids Associated hazardous wastes	<ul style="list-style-type: none"> Drill cuttings; Drilling fluids; Chemicals; Containers; PPE; Medical waste; Oily soil; Oily rags, filters etc.; Oily sludges; Pigging waste; Paint residue; Pipe dope; Spent welding rods etc.; Fabrication materials; and Used oils etc. 	<ul style="list-style-type: none"> High temperature combustion process used to reduce the volume of waste and toxicity prior to disposal; Typically used for the destruction or breakdown of organic compounds; and Can also be used liquid wastes, but may require changes to the process. 	<ul style="list-style-type: none"> Reduce the volume of waste and toxicity prior to disposal; and Relatively inexpensive in comparison to other treatment technologies. However, if built to international best practice standards to meet air emissions limits it can be relatively expensive for the scrubbers. 	<ul style="list-style-type: none"> Air quality and pollution impacts; Can result in accumulation of non-organics e.g. metals and salts in the ash; Ash, which is often classified as hazardous, should be disposed of at a landfill site designed for hazardous waste; and Certain wastes cannot be incinerated.
Treatment	Thermal Desorption	No	Drill cuttings Associated hazardous wastes	<ul style="list-style-type: none"> Drill cuttings; Oily soils; Oily sludges and Fabrication materials. 	<ul style="list-style-type: none"> Non-oxidising process using heat to volatilise contaminants (e.g. oils) so that they can be separated from contaminated materials (e.g. soil); Low temperature systems (250 °C – 350 °C) used to treat light oils and high temperature systems (up to 520 °C) used to treat heavier oils; and 	<ul style="list-style-type: none"> Effective in separating organics from oily and paint wastes. It can also be used to separate solvents and fuel oils from contaminated soil; and Typically uses less fuel than conventional heat treatment technologies due to the lower temperatures. 	<ul style="list-style-type: none"> Not effective for most metals; Does not destroy contaminants, which require additional treatment; and Relatively costly.



Waste hierarchy	Option	Locally Available	Waste category	Waste type	Description	Advantages	Disadvantages
					<ul style="list-style-type: none"> ■ Produces various waste streams, including solids, water condensate, oil condensate, and air stream from the compressor. 		
Treatment	Stabilisation	Yes	Drill cuttings	Drill cuttings	<ul style="list-style-type: none"> ■ Conversion of wastes to less soluble, mobile or toxic form in order to reduce the hazards associated with the wastes; and ■ Typically requires the addition of products to the waste, such as cement, fly ash, silicates, and other chemicals. 	<ul style="list-style-type: none"> ■ Relatively inexpensive. 	
Treatment	Evaporation	Yes	Drilling fluids	Drilling fluids	<ul style="list-style-type: none"> ■ Reduces the volume of liquid wastes by transforming the liquids into vapour; ■ Lagoons are typically used for evaporation, utilising the sun to drive the process. Evaporators can also be used to improve the efficiency of the system; and ■ Lagoons should be lined to reduce the risk to environment and human health and safety. 	<ul style="list-style-type: none"> ■ Reduce volume of waste requiring treatment/ disposal. 	
Treatment	Gravity Separation	Yes	Drilling fluids	Drilling fluids	<ul style="list-style-type: none"> ■ Typically used to treat liquid waste where the second waste (e.g. oil) has a different specific gravity than water; ■ Tank systems are traditionally used for this process, with the separation occurring over time; and ■ Maximum efficiencies can be achieved using heat, chemicals or pH. 	<ul style="list-style-type: none"> ■ Relatively inexpensive. 	
Treatment	Centrifugation	Yes	Drilling fluids	Drilling fluids	<ul style="list-style-type: none"> ■ Based on the principles of gravity separation. Centrifugal forces are introduced using an angular velocity, moving the waste in a circular motion, and making the separation process more efficient. 	<ul style="list-style-type: none"> ■ Commonly used in de-watering or handling of sludges. 	
Treatment	Filtration	Yes	Drilling fluids	Drilling fluids	<ul style="list-style-type: none"> ■ Separation of solids from a liquid by means of a porous medium or screen which retains the solids and allows the liquids to pass; and ■ Includes microfiltration, ultrafiltration, nanofiltration and reverse osmosis. 	<ul style="list-style-type: none"> ■ Typically more efficient and adaptable than other liquid treatment technologies; and ■ Can be used to target suspended solids, high molecular weight compounds, sulphates, salts and ions, and organic and inorganic compounds. 	<ul style="list-style-type: none"> ■ Relatively costly; ■ Design is dependent on the size of the particles to be removed and the quantity of solid materials present in the liquid; and ■ Membrane fouling without appropriate pre-treatment.



WASTE MANAGEMENT SPECIALIST ASSESSMENT

Waste hierarchy	Option	Locally Available	Waste category	Waste type	Description	Advantages	Disadvantages
Treatment	De-Watering (flocculation)	Yes	Drilling fluids	Drilling fluids	<ul style="list-style-type: none"> Removal of water from the waste mixture to produce a more concentrated mixture; Chemicals are typically used to allow suspended materials to flocculate and settle out; and The clarified water is recycled and the solid waste collected for treatment/disposal. 	<ul style="list-style-type: none"> Can be used to target heavy metals and suspended solids. 	<ul style="list-style-type: none"> Consistent sludge production which requires disposal; and Concentration of aluminium in liquid phase if aluminium is used as flocculent.
Treatment	Land Farming	No	Drill cuttings	Drill cuttings	<ul style="list-style-type: none"> Waste is spread to land where the microorganisms present in the soil biodegrade the hydrocarbon constituents; Differs from land spreading in that water and nutrients are added, and the material turned over periodically to increase the effectiveness of the process; and Treated material can potentially be used for construction or crop production, depending on the concentrations of non-biodegradable components. 	<ul style="list-style-type: none"> Relatively low capital costs; and Treat multiple loads of waste on same piece of land. 	<ul style="list-style-type: none"> Relatively large areas of land required; Relatively high operational costs; Requires frequent monitoring and testing; High levels of pre-treatment required to treat below hazardous waste thresholds; Currently no Ugandan thresholds; Potential accumulation of non-biodegradable components, such as metals, salts and PAHs; and Not suitable for drill cuttings with higher concentrations of oil, metals, and toxic additives.
Treatment	Bio-Treatment Centre	Yes	Drill cuttings	Drill cuttings	<ul style="list-style-type: none"> Based on the same principles as land farming; and However, treatment takes place in a more controlled environment e.g. tanks. The parameters, such as temperature, mixture of waste with air, nutrients, and water, are closely monitored and controlled to achieve maximum level of effectiveness. 	<ul style="list-style-type: none"> Requires less area to treat wastes than traditional land farming. 	<ul style="list-style-type: none"> Relatively high capital and operational costs;
Disposal	Mix-Bury-Cover	No	Drill cuttings	Drill cuttings (non-hydrocarbon based)	<ul style="list-style-type: none"> Mixing of non-hydrocarbon based drill cuttings with subsoil at a depth of 1 - 1.5 m. 	<ul style="list-style-type: none"> Relatively low capital and operational costs; and Option supported by the Ugandan government. 	<ul style="list-style-type: none"> Requires pre-treatment to meet thresholds for mixing with subsoil; and Requires frequent monitoring and testing.
Disposal	Land Spray / Pump-off	No	Drilling fluids	Drilling fluids	<ul style="list-style-type: none"> With land spray, drilling fluids are sprayed onto vegetated land or top soil. If the land is exposed, land spraying may involve incorporating the waste into the soil. This option may require separation of the solids from the liquids; and 	<ul style="list-style-type: none"> Low capital and operational costs. 	<ul style="list-style-type: none"> Not suitable for non-aqueous drilling fluids; Large areas of land required; and Site selection needs to take into account slope, proximity to roadways/properties, proximity to water resources, and application rates and concentrations.



WASTE MANAGEMENT SPECIALIST ASSESSMENT

Waste hierarchy	Option	Locally Available	Waste category	Waste type	Description	Advantages	Disadvantages
					<ul style="list-style-type: none"> With pump-off, clear liquids that have separated from the Water-based drilling fluids are sprayed onto adjacent lands, typically using sprinklers, gun spray systems, or vacuum tankers. 		
Disposal	Slurry / Annular Injection	No	Drill cuttings Drilling fluids	<ul style="list-style-type: none"> Drill cuttings; and Drilling fluids. 	<ul style="list-style-type: none"> In slurry injection, solid materials are ground down to particles of a suitable size, and combined with drilling fluids to create a slurry. The slurry is then injected into a confined formation at a high pressure where it becomes trapped in the formation; and In annular injection, the slurry is injected into the space between the two casing strings (i.e. annulus of the well), down to the desired formation. 	<ul style="list-style-type: none"> Potential for waste to come into contact with humans, wildlife, and vegetation is low; and One of the lowest rates of incidents. 	<ul style="list-style-type: none"> Can be costly, particularly if new well must be drilled; Dependent on availability of suitable geological formations i.e. target formation must be geologically and mechanically isolated from usable water sources; Annular injection not suitable for continuous disposal i.e. one-time option; Risk of contamination of usable water sources if the surface pipe is breached by corrosion; and May require some pre-treatment before injection e.g. oil removal, coagulation, filtration etc.
Disposal	Landfill	Yes	Drill cuttings General hazardous waste	<ul style="list-style-type: none"> Contaminated material Drill cuttings; Dry cell batteries; and Incinerator ash. 	<ul style="list-style-type: none"> Specifically designed and constructed to accommodate the burial of large volumes of non-liquid waste; Landfills generally include an impermeable lining, monitoring boreholes, and leachate collection and treatment system. 	<ul style="list-style-type: none"> Relatively low cost; however, if built to Class A equivalent standards and depending on the size it may be more costly; Relatively permanent solution; and Offers greatest local economic development and job creation potential. 	



Figure 17 summarises the BPEO for hazardous wastes generated during the construction and production, and decommissioning phases by the KDA project.

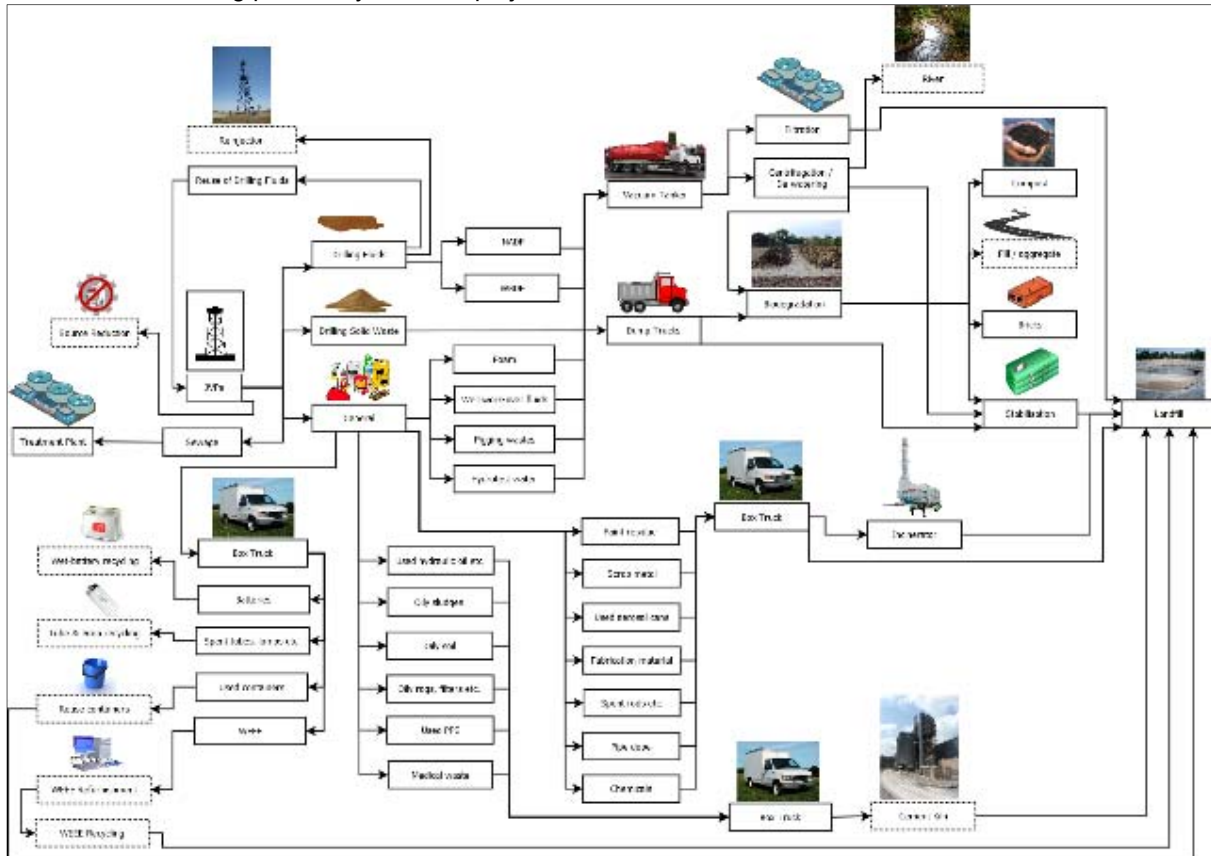

Figure 17: BPEO for Waste Collection, Transport and Treatment/Disposal

With regards to NADFs and cuttings, the BPEO is product substitution of the base fluid with one that is less toxic and has a higher biodegradation rate. This includes for example vegetable esters, low viscosity esters, and internal olefins²³. While these fluids may be less toxic or persistent than more traditional types of base fluids, their use might not be appropriate in all drilling conditions due to differing formations, water depths and temperatures. The selection of the base fluid should therefore not only be based on toxicity and biodegradation rate, but also on-site conditions. The use of 'clean' barite, with lower concentrations of cadmium and mercury, can also contribute to reduction in the toxicity of the drilling wastes. One component of the non-aqueous drilling fluids and cuttings that is of particular concern is PAH which can typically contain toxic priority pollutants, such as fluorene, naphthalene, and phenanthrene. Ideally the base fluid used should be free of PAH or have a PAH content of 0.001% or 10 ppm.

In the United States, the majority of non-aqueous drilling fluids and cuttings are treated via land farming whereby the waste is spread over small areas and allowed to biodegrade, forming clay-like substances which can be stockpiled adjacent the farming areas. The processing of the waste into a reusable construction aggregate is also another common practice. This process consists of dewatering the drilling waste and mixing the solids with binding and solidification agents, such as cement or lime. The oil and metals are stabilized within the solids matrix and cannot leach from the solids. More recently, Dispersion by Chemical Reaction (DCR) is also being used to treat drill cuttings, whereby Calcium Oxide is used to immobilise oils and heavy metals. The treated wastes are then used as daily cover at a Class I municipal

²³ United States Environmental Protection Agency (EPA) (2000), *Development Document for Final Effluent Limitations Guidelines and Standards for Synthetic-Based Drilling Fluids and other Non-Aqueous Drilling Fluids in the Oil and Gas Extraction Point Source Category*, EPA-821-B-00-013





landfill sites and/or base material for road construction and levee maintenance. Sub-surface reinjection at an independent waste disposal facility is another method used to dispose of the drilling wastes.

6.0 IMPACT ASSESSMENT

6.1 Impact Assessment Rating and Methodology

The methodology and approach to be followed for potential impacts for the proposed Project infrastructure including the (i) CPF, drilling wells and well pads, associated infrastructure, as well as (ii) the export pipeline to Kabaale during the construction, operational and closure or decommissioning phases are considered separately in this waste assessment.

6.1.1 Impact Classification

The purpose of the impact assessment process is to compare the intensity of the impact with the sensitivity of the receiving environment. The method relies on a detailed description of both the impact and the environmental or social component that is the receptor. The intensity of an impact depends on its characteristics, which may include such factors as its duration, reversibility, area of extent, and nature in terms of whether positive, negative, direct, indirect or cumulative.

The determination of significance of an impact is largely subjective and primarily based on professional judgment. However, the formal and general principles of the ESIA methodology herein has been detailed to provide meaning to the intensity of the rating with regard to the waste impact assessment of the proposed Project. The purpose of this impact classification for the waste study was to provide a system for ranking the severity of impacts, based on the intensity of the impact and the sensitivity of the receptor that is credible, robust and defensible; and to provide a clear approach for comparison among the categories the overall impact level for each described receptor during the phases of project development.

6.1.2 Type of Impact

The types of potential Project impacts considered appropriate for the waste assessment are summarised in Table 26.

Table 26: Types of Waste Impact

Direct Impact	Impacts that result from a direct interaction between a planned project activity and the receiving environment/receptors.
Indirect impact	Secondary impacts that result from project activity and affect the environment in which the receiving receptor is experienced.
Cumulative impact	Impacts that act together or combine with other impacts (including those from concurrent or planned activities) to affect the same resources and/or receptors of the Project.

6.1.3 Intensity

The first step in the impact severity classification was to determine the intensity, or magnitude, of the effect of the Project within the context of the waste study. The effect was quantified by combining the rankings of the criteria for direction, geographic extent, duration, and reversibility into a single measure of intensity for each key question and valued component.

Intensity describes the severity or magnitude of the effect. To provide a relative illustration of impact significance, it is useful to assign numerical descriptors to the impact **intensity** for each potential impact. Each is assigned a numerical descriptor of 1, 2, 3, or 4, equivalent to negligible, low, medium or high. To classify intensity using this scale in a manner meaningful for the waste study's valued components, the extent of the effect must be placed in the context of the valued component. That is, classifying intensity in a meaningful way depends on the pollution and/or contamination extent. For example, failure of the export pipeline would result in a high magnitude impact effect by polluting the underlying soil and groundwater over





a large area; whereas, the removal and disposal of the waste rock would result in a low magnitude impact effect on vegetation and soil in a small localised area of the escarpment. Fixed quantitative thresholds to define the intensity categories were not applied; however the qualitative descriptions of the potential for an effect of a given size to contribute to a substantial change in the environment were used (see Table 27).

Table 27: Intensity Assessment Rating Scale

Criterion	Criterion	Rating	Rating Scale Description
Intensity (the expected magnitude or size of the impact)	Negligible	1	Where the impact affects the environment in such a way that natural, and /or cultural and social functions and processes are negligibly affected and valued, important, sensitive or vulnerable systems or communities are negligibly affected.
	Low	2	Where the impact affects the environment in such a way that natural, and/or cultural and social functions and processes are minimally affected and valued, important, sensitive or vulnerable systems or communities are minimally affected. No obvious changes prevail on the natural, and / or cultural/ social functions/ process as a result of project implementation. Pollution and contamination of the air, soil, groundwater and / or vegetation is likely to small localised area requiring small scale clean-up.
	Medium	3	Where the affected environment is altered but natural, and/or cultural and social functions and processes continue albeit in a modified way, and valued, important, sensitive or vulnerable systems or communities are moderately affected. Pollution and contamination of the air, soil, groundwater and / or vegetation is likely to an area requiring moderate- scale clean-up and/or decontamination.
	High	4	Where natural and/or cultural or social functions and processes are altered to the extent that they will temporarily or permanently cease, and valued, important, sensitive or vulnerable systems or communities are substantially affected. The changes to the natural and/or cultural / social- economic processes and functions are drastic and commonly irreversible. Pollution and contamination of the air, soil, groundwater and / or vegetation is likely to cause severe destruction of the environment and affect a large area requiring extensive excavation / remediation.

6.1.4 Sensitivity

In order to derive an overall level of impact severity, which also reflected the expected extent of contamination or pollution outcome for the particular valued component activity, the predicted effect intensity was combined with a sensitivity value for the valued component.

For the intents of this waste impact assessment, sensitivity represents the vulnerability or resilience of the component activity on the receptor. In other words the sensitivity of the vegetation, soil, groundwater and air to contamination or pollution by the component activity. For example, the soil and groundwater are highly sensitive to contamination by hazardous wastes spills; whereas, the soil and groundwater are less sensitive to contamination by non-hazardous wastes spills.

Sensitivity for each valued component activity ranged from very low / negligible to high (Table 28).





Table 28: Sensitivity Assessment Rating Scale

Criterion	Rating	Rating Scale Description
Negligible	1	None of the below.
Low	2	Where natural recovery of the impacted area to the baseline or pre-project condition is expected in the short-term (1-2 years), or where the potentially impacted area is already disturbed by non-project related activities occurring on a scale similar to or larger than the proposed activity. Pollution and contamination of the air, soil, groundwater and / or vegetation is likely to be limited to a short period requiring small scale clean-up.
Medium	3	Where natural recovery to the baseline condition is expected in the medium term (2-5 years), and where marginal disturbance or modification of the receiving environment by existing activities is present. Pollution and contamination of the air, soil, groundwater and / or vegetation is likely to be limited to a medium-term period until the remediation can be effected.
High	4	Where natural recovery of the receiving environment is expected in the long-term (>5 years) or cannot be readily predicted due to uncertainty over the nature of the potential impact, and where unique or highly valued ecological, social or cultural resources could be adversely affected. Pollution and contamination of the air, soil, groundwater and / or vegetation is likely to persist in the environment with destructive effects over a long term period with limited treatment options available.

6.1.5 Impact Severity

The severity of impact is then indicated by the product of the two numerical descriptors of intensity and sensitivity, as in Table 29. This is a qualitative method designed to provide a broad ranking of the different impacts of a project.

It is important to note that this methodology used is based on the following: (1) the Ugandan authorities have approved this method (2) CNOOC’s partners have approved this method.

Table 29: Determination of Impact Severity

			Sensitivity of receptor			
			Negligible	Low	Medium	High
			1	2	3	4
Intensity of Impact	Negligible	1	1 Negligible	2 Minor	3 Minor	4 Minor
	Low	2	2 Minor	4 Minor	6 Moderate	8 Moderate
	Medium	3	3	6	9	12





		Sensitivity of receptor			
		Negligible	Low	Medium	High
		1	2	3	4
		Minor	Moderate	Moderate	Major
High	4	4 Minor	8 Moderate	12 Major	16 Major

6.2 Impact Assessment of the CPF, Wells and Associated Infrastructure

6.2.1 Construction Phase Impacts

The potential waste impacts that are related to the construction of the Project infrastructure phase are provided in the table below. The Groundwater Specialist Study, Soil Specialist Study and Surface Water Specialist Study for the proposed Project should be read in conjunction with this waste impact assessment. The construction phase activities that could potentially impact on the soil and groundwater resources include the materials handling and waste generation.

The potential waste impacts during the construction of project infrastructure are provided in Table 30.

Table 30: Construction Phase Impact Assessment of CPF, Wells and Associated Infrastructure

Receptor	Description	Type of Impact	Pre-mitigation			Post-mitigation		
			Sensitivity	Intensity of Impact	Impact Severity	Sensitivity	Intensity of Impact	Impact Severity
Soil, Vegetation and Habitat Loss	Excavations and removal of topsoil, overburden and vegetation	Direct	Medium	Medium	9 Moderate	Low	Low	4 Minor
Soil and Groundwater	Pollution from domestic / sanitary waste water discharge	Direct	Medium	Medium	9 Moderate	Low	Low	4 Minor
Soil, Surface water, Groundwater and Vegetation	Pollution from accidental chemical spills	Direct	Medium	Medium	9 Moderate	Low	Low	4 Minor
Soil, and Groundwater	Pollution from hazardous	Direct	High	Medium	12 Major	Low	Low	4 Minor





		Pre-mitigation				Post-mitigation		
	waste generation							
Air, Soil and Groundwater	Pollution from domestic waste generation	Direct	Medium	Medium	9 Moderate	Low	Low	4 Minor
Soil and Groundwater	Pollution from well drilling	Direct	Medium	Medium	9 Moderate	Low	Low	4 Minor
Soil and Groundwater	Pollution from well blow-out	Direct	High	High	16 Major	Low	Low	4 Minor

6.2.1.1 Excavations and Removal of Topsoil, Overburden and Vegetation

The Project areas will be cleared from any vegetation, excavated and levelled before any infrastructure can be constructed. This may lead to soil erosion or soil loss. Some of the soil and overburden will be used for backfilling during construction and the rest strategically stored as berms for future rehabilitation purposes. The impact for this activity on soil and vegetation is rated at **moderate** (9) before mitigation, because of the medium sensitivity and intensity of the impact expected without mitigation. The impact can however be reduced to **minor** (4) if adequate mitigation measures are put in place.

6.2.1.2 Domestic / Sanitary Waste Water Discharge

Domestic waste water from the construction camp kitchen, bathrooms, residential block, and administration areas will be provided at staff ablutions by ventilated chemical toilets and discharged in subsurface drains, until the permanent waste water treatment plant is completed. There is no current detail information on the expected volumes of domestic waste water that will be generated and the design of the systems. The impact description is therefore based on experiences from similar projects.

The presence of the additional workers on site during construction will increase the pressure on the sewage water systems and potential for overloading the existing waste water treatment systems is possible. This could result in spillages and malfunctioning of drain systems, which can lead to shallow soil, surface water and groundwater pollution. Alternatively, an option is to provide portable ablation facilities for areas along the construction routes such that the impacts are moderate rather than major.

The impact from this activity can potentially be **moderate** (9) if local communities are nearby the CPF and associated infrastructure areas; whereby, soil and groundwater resources in the area near the communities could become polluted from the waste disposal which can cause the outbreak of waterborne diseases such as cholera and hepatitis.

The impact can however be reduced to **minor** (4) if adequate mitigation measures are put in place. Mitigation will typically be the provision of clean water or hand washing and provision of portable toilets at the construction sites. These portable toilets need to managed and maintained in a manner that will protect the environment.

6.2.1.3 Accidental Chemical Spills

It is expected that large volumes of potential hazardous materials will be stored and handled at the CPF construction site. The spillage of oils, fuel and chemicals can result in the pollution of water resources if due care is not taken. The risk for a spill has to be considered as a potential impact. The impact is rated with a





medium intensity and medium sensitivity. The magnitude of the impact is considered to be **moderate** (9) before mitigation measures are adopted.

There is the potential for chemical soil contamination arising from spills and mis-management of materials, which can produce local contamination which is detrimental to vegetation and soil organism growth. Metals in soils arise from welding, grinding and poor waste management. Oils and greases arise from equipment operation. Accidental chemical spills have a detrimental effect on vegetation and soil organism growth.

Mitigation of these types of impacts will include the setup of site specific risk assessments and materials handling procedures by construction workers. All workers should be made aware of the risks associated with handling these hazardous materials and spill prevention and clean-up measures. With these applied mitigation measures the impact on the groundwater can be reduced to **minor** (4).

6.2.1.4 Associated Hazardous Waste Generation

Associated Hazardous waste materials will be generated during the construction phase ranging from used solvents, used oil and grease, etc. The magnitude of the soil and groundwater impact of the generation of hazardous waste before mitigation is expected to be **major** (12) (Ref. 32).

After the implementation of mitigation measures, such as the waste management plan, the magnitude can further be reduced to **minor** (4) and the potential impact will be of short term and limited to the directly affected site.

6.2.1.5 Non-Hazardous Waste Generation

The influx of construction workers and permanent staff on the flats will cause the generation of domestic waste from the residential and construction camp. The wastes generated will typically constitute food packaging, food waste, plastic bags, and water bottles, scrap metal and wood etc.

Currently the domestic waste is burned and buried but the volumes will increase to an extent that a formal waste handling/disposal site will have to be developed. If domestic waste is not properly disposed of or managed at a licensed facility it can lead to soil and groundwater pollution at informal dumping areas, or air pollution if burned. As such, domestic waste should rather be disposed at an appropriately licenced off-site facility. A formal waste management plan that takes in account the waste management hierarchy includes re-use and recycling, which will be required to reduce the impact from this activity on the air, soil and groundwater.

The impact is therefore rated as **moderate** (9) before mitigation and after mitigation can reduce to **minor** (4).

6.2.1.6 Well Drilling

There will be two types of drill fluids to be used at the Project area, and WBDFs and NADFs. WBDFs will be used to drill the upper portions of the well and is designed to be environmentally friendly containing water (from Lake Albert) and bentonite (Ref. 32).

The main concern for use of NADFs is safe disposal of the associated drill cuttings. Drilled cuttings removed from the wellbore are typically the largest waste streams generated during oil and gas drilling activities. The impacts on the soil and groundwater from drilling fluids will thus be related to improper handling, treatment and disposal of the drill fluids and cuttings that can cause soil and groundwater pollution. However, due to the use of the selected drill fluids, the impact is rated as moderate (9) before mitigation and reduce to low after considering the mitigation measures in place to safely handle and store drill fluids.

6.2.1.7 Well Blow - Out

A well blow-out is the uncontrolled release of crude oil from a well, resulting in the release of hydrocarbons, water-based mud and/or water. Blow-outs can occur during exploration or development drilling. They can also occur in the production stage, for instance during maintenance work on a well or due to escalation of a collision or a fire or explosion on the platform. The risk of a blow-out is minimal and not all blow-outs have significant environmental impacts. A blow-out will last until the well is under control again. This may take anywhere from a few hours if control can be regained using the safety systems, up to several months if an





additional well needs to be drilled to regain control over the first well. Experience has shown that control over wells can be regained in one or a few days if a blow-out should occur. (Ref. 32)

The crude oil mixture released during a blow-out, will have a detrimental effect on groundwater systems if not brought under control timeously; and is potentially the most severe and long-term environmental impact associated with oil and gas projects. However, blow out incidents are limited by the use of technology advances in drilling techniques and fluid management. The impact is listed here as **major** (16) based on the potential to cause detrimental damage to aquifers and other water sources in the case of a blow-out.

The mitigation measures reduce the impact to **minor** based on the low likelihood of such an incident occurring.

6.2.2 Operational Phase Impacts

The potential waste impacts during operation of the well drilling, production at the CPF and well pads is provided in Table 31.

Table 31: Operational Phase Impact Assessment of CPF, Wells and Associated Infrastructure

Receptor	Description	Type of Impact	Pre-mitigation			Post-mitigation		
			Sensitivity	Intensity of Impact	Impact Severity	Sensitivity	Intensity of Impact	Impact Severity
Soil and Groundwater	Pollution from hazardous waste generation	Direct	High	Medium	12 Major	Medium	Very Low	3 Minor
Air, Soil and Groundwater	Pollution from domestic waste generation	Indirect	Medium	Medium	9 Moderate	Medium	Very Low	3 Minor
Air, Soil and Groundwater	Pollution from temporary storage of hazardous waste	Direct	Medium	Medium	9 Moderate	Low	Low	4 Minor
Air, Soil and Groundwater	Pollution from temporary storage of domestic waste	Direct	Medium	Medium	9 Moderate	Low	Low	4 Minor
Air, Soil and Groundwater	Unauthorised disposal of waste to the environment	Direct	Medium	Medium	9 Moderate	Low	Low	4 Minor





Receptor	Description	Type of Impact	Pre-mitigation			Post-mitigation		
			Sensitivity	Intensity of Impact	Impact Severity	Sensitivity	Intensity of Impact	Impact Severity
Soil and Groundwater	Pollution from domestic waste water discharge	Direct	Medium	Medium	9 Moderate	Low	Low	4 Minor
Soil and Groundwater	Pollution from uncontrolled waste production water	Direct	High	High	16 Major	Low	Low	4 Minor
Soil, Surface water, Groundwater and Vegetation	Pollution from accidental chemical spills	Direct	Medium	Medium	9 Moderate	Low	Low	4 Minor
Soil and Groundwater	Pollution from associated infrastructure or flowline failure	Direct	High	High	16 Major	Medium	Medium	9 Moderate
Soil and Groundwater	Pollution from well drilling wastes	Direct	Medium	Medium	9 Moderate	Low	Low	4 Minor
Soil and Groundwater	Pollution from well blow-out	Direct	High	High	16 Major	Low	Low	4 Minor

6.2.2.1 Associated Hazardous Waste Generation

Hazardous waste may be generated during flow line and CPF maintenance activities. Hazardous waste generated during the operation phase ranging from used batteries, solvents, used oil and grease, etc. (see Section 3.1.2.3). The magnitude of the soil and groundwater impact of the generation of hazardous waste before mitigation is expected to be **major** (12). After the implementation of mitigation measures, such as the waste management plan, the magnitude can further be reduced to **minor** (4) and the potential impact will be of short term and limited to the directly affected site

6.2.2.2 Non-Hazardous Waste Generation

Domestic waste generation is common to both the construction and operational phase. As discussed in section 4.3 above, domestic wastes will mainly be generated at the drilling camp and permanent operators' accommodation camp. However, domestic waste is also expected to be generated in smaller amounts at the CPF, material yards (drilling and production) and associated offices, canteen and ablution blocks at the generated at the KDA.

Domestic waste is expected to be predominantly paper and wood waste, as well as food waste, plastics, glass and metals, which will be stored in suitable containers and removed on a regular basis for disposal at a





suitably licensed off-site disposal facility e.g. landfill site. Currently, domestic waste is burned and buried but volumes will increase during the operational phase to an extent that a formal appropriate off site waste disposal will be undertaken. If domestic waste is not properly disposed of or managed it can lead to soil and groundwater pollution at informal dumping areas, or air pollution if burned.

A formal waste management plan that includes re-use and recycling will be required to reduce the impact from this activity on the air, soil and groundwater source and a formal waste handling/disposal site will have to be developed. The waste management hierarchy approach will be adopted to reduce waste production and reuse or recycle materials wherever possible. Dry waste, such as plastic, cans, paper, cartons and glass will be recycled as far as possible and wet food waste will be sent to the appropriately licensed off site landfill.

The impact is rated as rated as **moderate** (9) before mitigation but is reduced after mitigation to **minor** (4).

6.2.2.3 Temporary Storage of Hazardous Waste

Temporary storage of hazardous materials presents various challenges. Different waste streams such as hazardous oils, solvents and chemicals should not be mixed in any way, but stored in separate containers and bays until removal to prevent any chemical reactions. Hazardous waste will be suitable stored until off site treatment and disposal by a local waste company.

The storage of hazardous waste is overall rated as **moderate** (9) before mitigation but is reduced after mitigation to **minor** (4).

6.2.2.4 Temporary Storage of Non-Hazardous Waste

Volumes of domestic non-hazardous waste expected to be generated will be low. It is expected to consist mainly of paper and wood waste, as well as food waste, plastics, glass and metals, which will be stored in suitable containers. Domestic waste should be removed on a daily basis.

Recyclable waste will be stored in separate containers from food waste. Currently, domestic waste is burned and buried but volumes will increase during the operational phase to an extent that a formal appropriate off site waste disposal by landfill will be undertaken for food waste. Whereas, recyclable materials such as metals, plastic, carton, glass, wood etc. will be sorted and temporarily stored until recycled onsite or sold and removed by contractors. If domestic waste is not properly stored it can lead to soil and groundwater pollution at informal unlined storage areas. Uncontrolled storage of domestic waste can lead to air pollution from rotting organic matter releasing methane and carbon dioxide.

The impact is rated as rated as **moderate** (9) before mitigation but is reduced after mitigation to **minor** (4).

6.2.2.5 Unauthorised Disposal of Waste

Illegal disposal or open burning of waste materials and littering can occur around the KDA. The environmental significance of illegal dumping occurring is rated as **moderate** (9) without any mitigation measures in place. It is expected that CNOOC will implement a waste management plan to manage all waste activities of the operations and this will serve to mitigate the illegal disposal of waste to the surrounding environment, reducing the environmental significance to **minor** (4).

6.2.2.6 Domestic / Sanitary Waste Water Discharge

According to the estimated waste inventory (see Section 4.3), the following amounts of domestic waste water are estimated to be generated from the various camps:

- Drilling camp generating about 15,000 m³ for approximately 250 people;
- EPC contractors camp generating about 20,000 m³ for approximately 250 people;
- Production camp generating about 10,000 m³ for approximately 250 people

Domestic waste water from the camps will be discharged in and treated to a permanent waste water treatment plant (WWTP).





There may be potential for soil and groundwater pollution as a result of spillages and malfunctioning of the WWTP system, which can lead to shallow soil and groundwater pollution. Domestic wastewater from operational sites needs to be collected and transported hence is prone to spillage. The impact for this activity which is the potential for soil and groundwater pollution is rated at **moderate** (9) before mitigation, because of the medium sensitivity and intensity of the impact expected without mitigation.

Mitigation measures include adequate design of the WWTP and management to handle the expected volumes of effluent and treated effluent discharge. Downstream groundwater monitoring of the systems is recommended especially in the case where groundwater may be used for domestic supply. Post mitigation the impact will be **minor**.

6.2.2.7 Waste Production Water

Waste production water will be generated at the CPF and re-injected into the wells; however, some have to be discharged but only once acceptable discharge limits are reached. Discharge of production waste water outside the boundary of the facilities will not be permitted owing to the sensitivity of the receiving environment. Separated produced water from the CPF will be utilised for local water injection requirements in the KDA. The impact for this activity which is the potential for soil and groundwater pollution is rated at **major** (16) before mitigation, because of the high sensitivity and intensity of the impact expected without mitigation.

Mitigation measures include adequate design of the integrity of the pipelines, treatment process and associated infrastructure, as well as to manage and handle the expected volumes of process water. Downstream groundwater monitoring of the systems is recommended especially in the case where groundwater may be used for domestic supply. Post mitigation the impact will be **minor**.

6.2.2.8 Accidental Chemical Spills

It is expected that large volumes of potential hazardous materials will be stored and handled at the drilling wells, CPF and well pads. The spillage of oils, fuel and chemicals can result in the pollution of soil and water resources if due care is not taken. The risk for a spill has to be considered as a potential impact. The impact is rated with a medium intensity and medium sensitivity. The magnitude of the impact is considered to be **moderate** (9) before mitigation measures are adopted.

There is the potential for chemical soil contamination arising from spills and mis-management of materials, which can produce local contamination which is detrimental to vegetation and soil organism growth. Metals in soils arise from welding, grinding and poor waste management in operations and maintenance. Oils and greases arise from equipment operation. Pigging waste arises from pipeline pumping stations and may lead to waste fluid/solid spills. Acid and/or alkaline spills and salinisation contaminating soil from pollution sources along preferential seepage path ways must be managed.

Mitigation of these types of impacts will include the setup of site specific risk assessments and materials handling procedures by construction workers. All workers should be made aware of the risks associated with handling these hazardous materials and spill prevention and clean-up measures. With these applied mitigation measures the impact on the groundwater can be reduced to **minor** (4).

6.2.2.9 Associated Infrastructure or Flowline Failure

The processes utilised at the CPF and the associated infrastructure and pipes are complex and in many instances involve high pressures. Potential failures of materials and equipment could result in the accidental release of hazardous materials and severe soil and groundwater pollution if not brought under control. As such the associated impact is determined as **major** (16) before mitigation. Mitigation will involve hazardous materials management plan including: equipment audits, flow line testing, inspections programs; as well as application of Standard Operating Procedures (SOPs). The probability of such an event taking place over the life time of the CPF and associated infrastructure is high before the mitigation but the impact rating is lowered to **moderate** (9) following mitigation. (Ref. 32)

6.2.2.10 Well Drilling Wastes

As indicated in section 6.2.1.6 above, drilling operations of development wells shall continue after the onset of the first oil production and associated impacts will therefore continue as well. Continued use of selected





drill fluids has the potential to have a **moderate** (9) impact before mitigation measures (i.e. measures in place to safely handle and store drill fluids) reduce it to **minor**. (Ref. 32)

6.2.2.11 Well Blow-Out

The impact of well blow-outs are outlined above in section 6.2.1.7 above and have the same impact rating during the operational phase; being **major** (16) due to its potential to cause detrimental damage to aquifers and other water sources. Again the impact is rated as **minor** following the implementation of mitigation measures. (Ref. 32)

6.2.3 Decommissioning Phase Impacts

The potential waste impacts during decommissioning and closure of the CPF, wells and associated Infrastructure are provided in Table 31.

Table 32: Decommissioning Stage Impact Assessment of CPF, Wells and Associated Infrastructure

Receptor	Description	Type of Impact	Pre-mitigation			Post-mitigation		
			Sensitivity	Intensity of Impact	Impact Severity	Sensitivity	Intensity of Impact	Impact Severity
Soil, Groundwater and Vegetation	Removal of existing industrial structures	Direct	Medium	Medium	9 Moderate	Medium	Negligible	3 Minor
Soil and Groundwater	Pollution from hazardous waste generation	Direct	High	Medium	12 Major	Medium	Negligible	3 Minor
Air, Soil and Groundwater	Pollution from non-hazardous / domestic waste generation	Indirect	Medium	Medium	9 Moderate	Medium	Negligible	3 Minor
Air, Soil and Groundwater	Temporary storage of dismantled used infrastructure materials	Direct	Medium	Medium	9 Moderate	Low	Low	4 Minor
Soil and Groundwater	Closure of any onsite waste storage areas	Direct	Medium	Medium	9 Moderate	Low	Low	4 Minor

6.2.3.1 Existing Industrial Structures

Existing industrial structures will be removed and the topography will be returned (as far as possible) to its former state.

The environmental significance of the decommissioning activities in general are rated as **moderate** before mitigation, but with the implementation of a decommissioning plan this is reduced to **minor**. It is uncertain





how extensive this phase would be at this stage, but will at least involve the dismantling of the production / injections wells, wellpads, flowlines, CPF, accommodation camps, offices and associated infrastructure. It is possible that some infrastructure might be used for other purposes and this possibility will only be verified at a later stage. Many of the materials will be recycled as far as possible. Contaminated materials will not be recyclable and those that cannot be removed by waste contractors will need to be disposed of at suitably licenced off site treatment and disposal landfill sites. Stored topsoil and fill material will be used to return the site as close as possible to its pre-development state.

6.2.3.2 Hazardous and Non-Hazardous Waste Generation

Hazardous and non-hazardous / domestic waste streams similar to those generated during the construction and operational phase (see details in Sections 6.2.1.4 and 6.2.1.5) will be generated during closure. The impact severity for hazardous waste generation is expected to be **major** and the impact severity for domestic waste generation is expected to be **moderate**. However, after appropriate mitigation both are expected to have a **low** impact severity.

6.2.3.3 Temporary Storage of Dismantled used Infrastructure Materials

Temporary storage of dismantled used infrastructure materials, steel works, equipment, building rubble and other waste will occur during the closure phase: The environmental significance of the temporary storage of dismantled structure materials, rubble, steel structures, equipment etc. is rated as **moderate** before mitigation. The significance will be reduced to **minor** with the implementation of the decommissioning plan. The impact will be limited to the KDA only and will be for a short-term period lessening the potential impact on the surrounding area.

6.2.3.4 Closure of any Onsite Waste Storage Areas

Closure and rehabilitation of any onsite storage areas will occur during closure. The storage areas will be closed and rehabilitated last once all wastes have been appropriated disposed at offsite licenced facilities. The environmental significance of this activity before mitigation is rated as **moderate**, but with an approved closure and rehabilitation plan in place this would be reduced to a **minor** rating. All activities will have ceased and a monitoring plan will be implemented to ensure the facility does not pose any threats to the surrounding environment. The monitoring period will be determined by the authorities.

6.3 Impact Assessment of Export Pipeline

6.3.1 Construction Phase Impacts

During the construction phase of the export pipeline, the impacts from waste will largely be similar to those as detailed during the construction of the CPF, wells and associated infrastructure in 6.2.1 particularly with regard to the excavation and removal of topsoil, overburden and vegetation; domestic / sanitary waste water discharge; accidental chemical spills; and the generation of hazardous and non-hazardous wastes. Some additional specific impacts during construction of the export pipeline with regard to the waste rock handling and domestic / sanitary wastewater are detailed below.

Table 33: Construction Phase Impact Assessment of the Export Pipeline

Receptor	Description	Type of Impact	Pre-mitigation			Post-mitigation		
			Sensitivity	Intensity of Impact	Impact Severity	Sensitivity	Intensity of Impact	Impact Severity
Soil, Vegetation and Habitat Loss	Removal and disposal of the waste rock	Direct	Low	Low	4 Minor	Low	Low	4 Minor





		Pre-mitigation				Post-mitigation		
Soil and Groundwater	Pollution from domestic / sanitary waste water discharge	Direct	Medium	Medium	9 Moderate	Low	Low	4 Minor

6.3.1.1 Waste Rock

With regard to the handling of the waste rock (which although expected to be minimal other than on the escarpment section) the impact from the activity would be **minor** (4) where waste rock is either returned to the trench (where possible), or removed and disposed along the right of way (RoW).

6.3.1.2 Domestic / Sanitary Waste Water Discharge

Provisions for staff ablutions will be provided by ventilated chemical toilets along the export pipeline construction route.

The impact from this activity can potentially be **moderate** (9) if local communities along the pipeline route’s soil and groundwater resources are polluted from the waste disposal which can cause the outbreak of waterborne diseases such as cholera and hepatitis.

The impact can however be reduced to **minor** (4) if adequate mitigation measures are put in place. Mitigation will typically be the provision of clean water or hand washing and provision of portable toilets at the construction sites. These portable toilets need to be managed and maintained in a manner that will protect the environment.

6.3.2 Operational Phase Impacts

During the operational phase of the export pipeline, the impacts from waste will largely be similar to those as detailed during the operational phase of the CPF, wells and associated infrastructure in 6.2.2 particularly with regard to associated hazardous and non-hazardous waste generation and the temporary storage thereof; and unauthorised disposal of waste; domestic / sanitary waste water discharge (as detailed also in Section 6.3.1.2); and any accidental chemical spills.

The main additional specific impact during operation regards potential failure of the export pipeline or flowline as detailed below.

Table 34: Operational Phase Impact Assessment of the Export Pipeline

		Pre-mitigation				Post-mitigation		
Receptor	Description	Type of Impact	Sensitivity	Intensity of Impact	Receptor	Description	Type of Impact	Sensitivity
Soil and Groundwater	Pollution from pipeline/ flowline failure	Direct	High	High	16 Major	Medium	Medium	9 Moderate

6.3.2.1 Export Pipeline or Flowline Failure

The processes utilised at the CPF and the export pipeline to Kabaale are complex and in many instances involve high pressures. Potential failures of materials and equipment could result in the accidental release of hazardous materials and severe soil and groundwater pollution if not brought under control. The main





pipeline to Kabaale will follow a route through several communities that are dependent on groundwater as the main water supply.

The associated impact is therefore determined as **major** (16) before mitigation. Mitigation will involve hazardous materials management plan including: equipment audits, flow line testing, inspections programs; as well as application of Standard Operating Procedures (SOPs). The probability of such an event taking place over the life time of the plant and pipeline is high before the mitigation but the impact rating is lowered to **moderate** (9) following mitigation.

6.3.3 Decommissioning Phase Impacts

During the closure or decommissioning phase of the export pipeline, the impacts from waste will largely be similar to those as detailed during the decommissioning of the CPF, wells and associated infrastructure in 6.2.3 particularly with regard to existing pipeline structures; hazardous and non-hazardous waste generation; temporary storage of dismantled used infrastructure materials; and closure of any onsite waste storage areas.

7.0 RECOMMENDATIONS FOR MITIGATION/MANAGEMENT AND MONITORING MEASURES

In each of the stages of the Project, waste mitigation measures have been considered, the aim of which was to reduce all predicted impacts to moderate or lower.

The Project will comply with the Ugandan National Environment (Waste Management) Regulations and the National Environment Management Authority (NEMA, Operational Waste Management Guidelines for Oil and Gas Operations (Table 1) with special focus on areas with limited as indicators of best international practice.

7.1 Mitigation of Impacts at the CPF, Wells and Associated Infrastructure

7.1.1 Construction Phase

7.1.1.1 Excavations and Removal of Topsoil, Overburden and Vegetation

Excavations and removal of overburden and topsoil will be minimised as far as possible. It is recommended that excavation and removal of topsoil, overburden and vegetation be done under the supervision of soil specialists and botanists. These specialists will advise on the soil classification and appropriate storage of soil types, and advise on vegetation species to prevent impacts on soil and vegetation respectively

Some of the topsoil and overburden material removed during the construction phase will be used for backfilling and building of roads while the rest will be stored as berms at strategic areas around the KDA. These stockpiles will be sloped and capped to prevent erosion and loss of material. The integrity and aesthetics of the capping layer will further be enhanced by vegetating it with suitable natural plants and grasses indigenous to the area. Storm and run-off water management systems will be implemented to divert storm and run-off water away from these stockpiles.

7.1.1.2 Domestic / Sanitary Waste Water Discharge

Sewage waste from workers camps etc. should be treated and disposed of in accordance with National Environment (Standards for Discharge of Effluent into Water or on Land) Regulations, S.I. No 5/1999. Reference also needs to be made to World Bank Group EHS Guidelines, Onshore Oil and Gas Development, 2007. Sanitary sewage must be treated to meet the discharge limits of the Company requirements as stated in Table 35 (Ref.32)

Table 35: Standards for Discharge of Effluent (Ref. 32)

Table with 5 columns: Parameter, Unit, Uganda, IFC, Company requirement. Row 1: pH, pH, 6-8, 6-9, 6-8





Parameter	Unit	Uganda	IFC	Company requirement
BOD	mg/l	50	30	30
COD	mg/l	100	125	100
Total nitrogen	mg/l	10	10	10
Total phosphorus	mg/l	10	2	2
Oil and grease	mg/l	10	10	10
Total suspended solids	mg/l	100	50	50

Pollution from domestic (i.e. sanitation) wastewater may be prevented by the appropriate location and use of sanitation facilities. Maintenance and integrity inspections of the facilities and associated pipelines are required, as well as, appropriate load removal and treatment through the WWTPs.

Mitigation measures include adequate design and management to handle the expected volumes of wastewater and allow drainage in order not to cause flooding or over saturation of the subsurface.

During the construction phase of the well pads and pipeline (located away from the construction camp), sanitation waste will be generated by workers. There is no permanent ablution facilities associated with these construction sites, and the workers will have to be provided with adequate sanitation solutions on site to prevent the disposal of waste in unsanitary manners. The informal disposal of these wastes can lead to pollution of the soil and groundwater resources at the construction sites. (Ref. 32)

7.1.1.3 Accidental Chemical Spills

Once waste is contained the containers should be stored in a designated area with secondary containment. Ideally a spill kit should be located within the vicinity of the waste storage areas. A PPE storage box and spill kit should be placed within immediate vicinity of waste storage areas. The storage area should be constructed to allow sufficient ventilation and minimize water from collecting in the accumulation area.

7.1.1.4 Hazardous and Non-Hazardous Waste Generation

Waste streams can be subdivided into three broad groups: Recyclable / Recoverable, Non-hazardous, and Hazardous. In order to achieve a successful waste segregation program, waste should be segregated at the source area. Once the waste is contained the containers should be stored in a designated area with secondary containment.

The following measures will be implemented to mitigate the impact of pollution from waste that is generated:

- Development and implementation of a Waste Management Plan for the project;
- Adopt the waste management hierarchy as follows:
 - Prevent and minimise general and hazardous waste generation as far as possible;
 - Re-use waste during construction where possible;
 - Recycle or sell waste to recycling contractors where possible during construction;
- Separate waste at source by separating domestic food and recyclable waste; domestic waste from hazardous waste, and non-compatible hazardous wastes (e.g. acid and toxic).
- Recycle wherever possible;
- Provide suitable labelled containers and temporary storage areas as close to the point of generation as practical possible;





- Off-site waste recovery, recycling, treatment or landfilling at suitably licenced facilities only to ensure unusable waste is disposed of in an environmentally responsible manner (“cradle to grave” responsibility).

The waste management hierarchy is an internationally accepted guide to prioritise waste management options and aims to achieve optimal environmental results. The main priority should be to prevent the generation of waste. If not possible, waste should be minimised or re-used as far as possible. R

7.1.1.5 Well Drilling

Pollution from well drilling stored and/or disposed in pits will be mitigated by the applying the following (Ref. 32):

- Pits should be lined and tested for integrity prior to use;
- Bottom of pits should be higher than 5 m above the seasonal high water table;
- Prevention of natural surface drainage entering the pits during rains;
- Installation of a perimeter fence around the pits or installation of a screen to prevent access by wildlife (including birds), livestock, and people;
- Pit closure should be completed as soon as practical, but no longer than 12 months, after the end of operations; and
- If the drilling waste is to be buried, the Mix-Bury-Cover disposal method should be used.

The pits must be impermeable and possess suitable runoff protection and drainage to prevent impacts to the lake.

7.1.1.6 Well Blow-Out

The drilling fluid is the primary safeguard against blow-out of hydrocarbons from a well and its density can be controlled to balance any anticipated formation pressures. The drilling mud will be tested from time-to-time during the drilling process and its composition adjusted to account for any changing down-hole conditions. The mud density will be adjusted as required by an on-site chemist. The likelihood of a blow-out will be further minimized by using a specially designed blow-out preventer (BOP). When installed on top of the well-bore, a BOP will close the well automatically in case of a blowout. (Ref. 32)

7.1.2 Operational Phase

7.1.2.1 Hazardous Waste Generation

The following measures will be implemented:

- Develop and implement an Waste Management Plan for the project, including objectives for the collection, storage, transport, minimization and disposal of all hazardous and non-hazardous wastes generated;
- Employees and the community will be educated to ensure the objectives of the Waste Management Plan are achieved;
- Demarcated temporary collection/storage areas with suitable waste bins for hazardous waste will be provided at strategic places;
- Hazardous waste streams will be labelled and stored separately and recycled as far as possible to minimise volumes requiring landfilling; and
- Where possible hazardous waste will be returned to the suppliers.
- Waste is to be taken to the closest appropriately licenced waste recycling, treatment and disposal facilitates for the management of hazardous wastes in accordance with a priority to reduce, reuse, and





recycle waste (e.g. oils, greases and oil contaminated absorbents) then treatment and lastly landfill or incinerate wastes generated.

- If no appropriate licenced facilities are available near the KDA, studies should be undertaken to develop a nearby suitably licenced facility.

See further details about mitigation as detailed for the construction phase which will be the same during operation as detailed in Section 7.1.1.4.

7.1.2.2 *Non-Hazardous Waste Generation*

The following measures will be implemented:

- A Waste Management Plan should be developed and implemented for the project, including objectives for the collection, storage, transport, minimisation and disposal of all wastes generated;
- Employees and the community will be educated to ensure the objectives of the Waste Management Plan are achieved;
- Demarcated areas with suitable waste bins will be provided for non-hazardous domestic recyclable and wet food wastes;
- Waste will be separated and recycled at source as far as possible to minimise volumes requiring landfilling.
- Waste is to be taken to the closest appropriately licenced waste recycling, treatment and disposal facilities for the management of non-hazardous wastes in accordance with a priority to reduce, reuse, and recycle waste (e.g. ferrous and nonferrous wastes, glass, paper and plastics), then treatment (e.g. compost food wastes) and lastly landfill or incinerate wastes generated.
- If no appropriate licenced facilities are available near the KDA, studies should be undertaken to develop a nearby suitably licenced facility.

See further details about mitigation as detailed for the construction phase which will be the same during operation as detailed in Section 7.1.1.4.

7.1.2.3 *Temporary Storage of Hazardous Waste*

The following measures to prevent the impact will be implemented:

- Development and implementation of a Waste Management Plan for the project, including objectives for the collection, storage, transport, minimisation and disposal of all hazardous and general domestic wastes generated;
- Employees and community will be educated to ensure the objectives of the Waste Management Plan are achieved;
- All hazardous waste streams will be identified (inventory), sent for testing to be classified to ensure their toxic components are known and to ensure it is managed and disposed of in a safely manner in accordance with local and international best practice standards;
- Hazardous wastes will be stored in sealed containers constructed of a suitable material and will be labelled in terms of best international practices;
- All hazardous waste will be stored, transported, and disposed of in compliance with the relevant legislation for hazardous waste, ideally off site treatment by a local waste company;
- Hazardous waste storage areas will be positioned away from any storm water drains and watercourses and away from moving vehicles and equipment to prevent accidental spills;
- The waste storage/sorting areas will at least comply with the following:



- The migration of any accidental spillage of hazardous liquids or materials into the soil and groundwater regime around the temporary storage area will be prevented;
 - The area will be provided with an impervious base to prevent ingress of leach;
 - The area will be provided with a spill containment sump to accommodate a volume equal to 1.5 times the volume of all containers stored on it as well as precipitation from a 25 year storm event, plus the greater of 10% of the aggregate volume of all containers or 100% of the capacity of the largest tank within its boundary, whichever is greater;
 - Any contaminated liquid will be treated before re-use or being released;
 - Different and incompatible wastes such as chlorine and ammonia will be clearly labelled and stored separately to prevent any chemical reactions such as release of toxic fumes, combustion and fire hazards from occurring;
 - Throughout the rainy season, temporary containment will be covered during non-working days, and prior to rain events. Covered facilities may include use of plastic tarps for small facilities or constructed roofs with overhangs;
 - Drums will not be overfilled and different wastes types not be mixed;
 - Waste containers will be clearly labelled with the words “Hazardous Waste”.
- The production or generation of hazardous waste will be minimised as far as possible;
 - Liquid or semi-liquid hazardous waste in will be kept in appropriate containers (closed drums or similar) and/or under cover;
 - All hazardous waste containers will clearly be labelled with the waste being stored and the starting date of accumulation;
 - Potentially hazardous waste materials will not be accumulated on the ground;
 - The original label of liquids and materials will not be removed as it contains important safety and disposal information;
 - Replacement of toxic raw materials with more environ-friendlier resources will continuously be considered; and
 - Hazardous waste will be separated and recycled as far as possible to minimise volumes requiring off site treatment or disposal by local contractors.

7.1.2.4 Temporary Storage of Non-Hazardous Waste

The following measures will be implemented:

- A Waste Management Plan will be implemented;
- Employees and the community will be educated to ensure the objectives of the strategy are achieved;
- Sufficient storage and waste bins will be provided as close to the point of generation as possible; and
- Suitably designed central sorting and temporary storage area (salvage yard) for general domestic and industrial wastes will be provided.

7.1.2.5 Unauthorised Disposal of Waste

The following measures should be implemented:

- An integrated Waste Management Plan for the KDA will be implemented which should include the collection, transport, storage, recycling and disposal of all waste materials, but also regular auditing and the on-going monitoring of all waste management activities;



- Corrective actions for non-compliance with the management plan should be implemented;
- Regular environmental audits and inspections of the surrounding area will be undertaken to identify any environmental concerns and take action to rectify them; and
- Workers and the community should be educated and trained to ensure the environment is kept clean and a reporting system be implemented to report transgressors.

7.1.2.6 Domestic / Sanitary Waste Water Discharge

Storm water should be separated from waste production water and domestic waste water (i.e. sanitary) streams wherever possible in order to reduce the volume of wastewater to be treated prior to discharge (See mitigation as detailed in Section 7.1.1.2).

7.1.2.7 Uncontrolled Waste Production Water

Storm water should be separated from waste production water and domestic waste water (i.e. sanitary) streams wherever possible, in order to reduce the volume of wastewater to be treated prior to discharge. Process wastewater must be treated and either recirculated to the plant processes or releases to the environment only once appropriate discharge levels are met and the treated water does not harm the environment it is released into. Treatment processes and associated pipes must be integrity testing and of suitable size with bunding to take into account 1:50 storm water events.

7.1.2.8 Accidental Chemical Spills

The following measures in addition to those detailed in Section 7.1.1.3 will be implemented to prevent the impact:

- Storage areas for liquid and hazardous wastes will be lined;
- Hazardous liquid waste should be placed in suitable sealed containers and labelled to prevent accidental spills to the ground;
- Containment berms or bunds will be provided in fuelling and maintenance areas and where the potential for spills is high;
- Secondary containment and/or drip trays are used for any liquid material stored in drums or tanks;
- Strategically located and adequate supplies of spill kits to control and prevent spills should be provided;
- Only trained persons should handle hazardous wastes;
- Vehicles transporting waste should be purposely built and all display signage and emergency contact details;
- Fuel storage and refuelling procedures should be stringent so that no refuelling or transferring fuel occurs after dark or when light conditions are low;
- Only trained and informed persons should transport hazardous wastes;
- Only adequately licenced waste haulage companies and disposal companies should collect and dispose wastes;
- Strict speed limits should be imposed on hazardous waste vehicles; and
- Access roads should be well maintained to ensure a safe trip to the off-site landfill.

7.1.2.9 Associated Infrastructure or Flowline Failure

Failure of infrastructure associated with the CPF can be prevented by choosing the right materials suited to the product transported, equipment and appropriate maintenance. Testing of equipment should be undertaken to check the pressure and subjecting it to above the operating pressure during testing, to prevent





out defects before they reach a critical size in service should also be used to detect corroded infrastructure before it fails in service.

7.1.2.10 Well Drilling Wastes

The impact from drillings muds and cuttings will be prevented by the following:

- Mud recovery systems should be used to minimise amounts of drill fluids to be ultimately discharged;
- Slurry collected in pits should be dewatered and then retained for enough time to allow evaporation to reduce volume of fluid that requires treatment and ultimate treatment or disposal;
- Alternative beneficial disposal options from the drilling cuttings should be explored, e.g. treated cuttings can be used for brick making and/or applied as surfacing aggregate material on local gravel roads, if non-hazardous;
- Biocides used to preserve geo-chemical samples should be avoided; and
- All pits should have contents appropriately treated after drilling and disposed before backfilling.

See mitigation as detailed in Section 7.1.1.6.

7.1.2.11 Well Blow-Out

The risk of well blowout will be mitigated by the following (Ref 13):

- A blow out preventer will be installed and regularly tested for effectiveness to prevent deeper hydrocarbon type blow-outs during drilling; and
- Gas detection systems should be installed to give early indication of any potential for gas blow out.

See mitigation as detailed in Section 7.1.1.6. In order to prevent a catastrophic well blow-out, a management plan should be developed and measures put in place to clean-up soils and groundwater,

7.1.3 Decommissioning Phase

7.1.3.1 Removal of Existing Industrial Structures

The following measures will be implemented to mitigate potential impacts:

- Topsoil stockpiles preserved since the construction phase will be used to level and rehabilitate the area to its original condition;
- Natural vegetation of the area will be re-introduced; and
- All re-usable materials and equipment will be recycled as far as possible;
- The pits from well drilling need to be filled and landscaped to prevent disturbance and mortality of birds and other species feeding in the area. No biocides or other highly toxic chemicals to suppress microflora in the drilling and other circulating fluids should be used. Under no circumstances should cutting be discharged into Lake Albert.

7.1.3.2 Hazardous and Non-Hazardous Waste Generation

See further details about mitigation as detailed in Section 7.1.1.4. Domestic and hazardous wastes that cannot be recycled will be treated or landfilled at appropriately licensed offsite facilities. This will be one of the last activities to take place on site only once all other decommissioning activities and associated plant and infrastructure has been removed from the KDA.

7.1.3.3 Storage of Dismantled used Infrastructure Materials

The following measures will be implemented to mitigate potential impacts:

- Dismantled and used materials will be sorted at source;





- Hazardous and contaminated waste will be disposed of the appropriately offsite facilities;
- Landfilling of any waste will be implemented only as a last resort; and
- Any deviations from set environmental requirements and standards during this phase will be addressed immediately.

7.1.3.4 Closure of any Onsite Waste Storage Areas

The following measures will be implemented to mitigate potential impacts:

- The storage areas will be finally shaped and rehabilitated in compliance of a locally approved closure plan and international industry best practices to limit soil, surface and groundwater impacts;
- An approved environmental monitoring plan (boreholes, air, integrity, vegetation etc.) will be implemented to monitor the areas with the most impacts after closure on an ongoing long-term basis for as long as required by the authorities; and
- Any deviations from set environmental requirements and standards during this period will be addressed immediately.

7.2 Mitigation of Impacts at the Export Pipeline

7.2.1 Construction Phase

7.2.1.1 Waste Rock

The following measures will be implemented to mitigate potential impacts:

- Generation of waste rock will be minimal and limited to the escarpment section of the pipeline
- If removed the waste rock will be returned to the trench
- As a last resort the waste rock will be removed to an identified suitably licensed dissal site along the RoW.

7.2.1.2 Domestic / Sanitary Waste Water Discharge

Measures implemented to mitigate potential impacts of sanitary waste water discharge on the environment around the export pipeline would be the same as those identified at the CPF – see Section 7.1.1.2.

7.2.2 Operational Phase

7.2.2.1 Export Pipeline or Flowline Failure

Failure of the export pipeline to Kibaale can be prevented by choosing the right materials suited to the product transported, equipment and appropriate maintenance and testing of the pipeline. Hydrostatic testing by which the pipeline is subjected to pressure above the operating pressure, to blow out defects before they reach a critical size in service should also be used to detect corroded pipe before it fails in service. A pipeline integrity strategy should be compiled; to guide inspection and preventive maintenance to ensure the integrity of the pipeline (Ref. 32).

In order to prevent a catastrophic pipeline failure, a management plan should be developed and measures put in place to clean-up soils and groundwater.

7.2.3 Decommissioning Phase

Measures implemented to mitigate potential impacts on the environment during decommissioning of the export pipeline would be the same as those identified at the CPF – see Section 7.1.3.

8.0 LIMITATIONS

Limitations to this waste study include the following which requires further investigation:



- Confirmation of the types, quantities and hazardous rating of a detailed waste inventory for waste quantities generated during construction of project infrastructure, operation of drillings wells and production of the CPF and well pads;
- Waste classification of wastes generated at the KDA may only be determined in terms of hazardous properties once they are generated and sent for analytical testing; and
- Development of an integrated Waste Management Plan for the proposed Project at the KDA once the project is underway.

9.0 CONCLUSION

This assessment has considered potential waste impacts associated with the proposed Project at the KDA.

Ugandan legislation and guidelines, and International IFC Performance Standards and EHS Guidelines and international best practice were reviewed in the context of the proposed Project.

The baseline study of is based on the estimated waste inventory received from the three O&G companies, including CNOOC and are also based on Golder's experience on past similar O&G projects with similar processes during construction, operation and closure.

Waste impacts associated with the different phases of the Project were then assessed against the adopted evaluation criteria for receptors, including air, soil, surface water, groundwater and vegetation, in the KDA. The impacts during the construction and decommissioning phases are similar mainly limited to the generation of non-hazardous and hazardous waste, the management of wastes, material and chemical handling, and process and domestic / sanitary waste water. Impact during operation relate to these impacts, as in the construction phase, but also include the well drilling, well blow-out and potential infrastructure and pipe failure, Most of the impacts are rated as major or moderate, and in all cases can be reduced to minor through mitigation and management measures.

Mitigation includes the development of a waste management plan for the proposed Project at the KDA, adopting the principles of the waste hierarchy, ensuring international and best practice methods for chemical, material and waste storage, handling, transporting and disposal at suitably licenced facilities.

10.0 REFERENCES

- 1) Scoping Report for the Environmental and Social Impact Assessment for Kingfisher Discovery Area in Hoima District, Uganda, by CNOOC Uganda Ltd. - Golder Associates and Eco & Partner, December 2013
- 2) Final Scoping Report for the ESIA for the KDA in Hoima District, Uganda by Cnooc Uganda Ltd dated August 2017 (Golder project Ref: 1776816).
- 3) The Constitution of the Republic of Uganda, 1995
- 4) National Environment Management Act, 1995
- 5) The Land Act, 1998
- 6) The Water Act, 1997
- 7) The Penal Code, 1950
- 8) The Mining Act, 2003
- 9) Occupational Safety and Health Act, 2007
- 10) Public Health Act, 1935
- 11) Petroleum (Exploration, Development and Production) Act, 2013
- 12) The Petroleum (Refining, Conversion, Transmission and Midstream Storage) Act 2013





- 13) Atomic Energy Act, 2008
- 14) Atomic Energy Regulations, 2012
- 15) National Environment (Waste Management) Regulations, 1999
- 16) *Draft Proposed National Air Quality Standards for Various Sources*, 2017
- 17) National Environment (Standards for Discharge of Effluent into Water or on Land) Regulations, 1999
- 18) The Environmental Impact Assessment Regulations, 1998
- 19) Petroleum (Exploration, Development and Production) Regulations, 2016
- 20) *Draft Petroleum (Waste Management) Regulations*, 2017
- 21) The Petroleum (Exploration, Development and Production) (National Content) Regulations, 2016
- 22) The Petroleum (Refining, Conversion, Transmission and Midstream Storage) (National Content) Regulations, 2016
- 23) The Petroleum (Exploration, Development and Production) (Health, Safety and Environment) Regulations, 2016
- 24) General Environmental Health and Safety Guidelines, 1. Environmental, 1.6 Waste Management. International Finance Corporation, 2007.
- 25) Industry Sector Guidelines, Environmental Health and Safety Guidelines for Onshore Oil and Gas Development. International Finance Corporation, 2007.
- 26) EHS Guidelines for Waste Management Facilities, 2007
- 27) CNOOC, Waste Management Specification, (CUL-QHSE-L3(GE)-053)
- 28) CNOOC, Health, Safety & Environment Handbook
- 29) Drilling Waste Management Technology Review, International Association of Oil & Gas Producers (IOGP), Report 557, June 2016.
- 30) Non-Hazardous Waste Management Infrastructure Concept Study for the Integrated Development of the Lake Albert Oil Fields, Atacama Consulting, July 2017.
- 31) Consultancy Services to Develop Ugandan Capacity to Manage Hazardous Waste from Oil Fields, Golder Associates Africa (Pty) Ltd Ref: 1546406-313731-1, August 2017.
- 32) Groundwater Report, Environmental and Social Impact Assessment for Kingfisher Development Area, Hoima District, Uganda, Golder Associates Africa (Pty) Ltd Golder project Ref: 1776816, August 2017.
- 33) The E&P Forum, Exploration and Production (E&P) Waste Management Guidelines, Report No. 2.58/196, September 1993.
- 34) AMEC Environment & Infrastructure UK Ltd, *BPEO for Drilling Wastes*, Tullow Operations Uganda Pty Ltd, London, United Kingdom, 2014.
- 35) CNOOC, Kingfisher Field Development Project, Waste Management Study Report, Document Ref. KF-FD-RPT-GEN-SA-1027 REVB, 19 September 2017.





Author: Natalie Kohler
Waste Management Consultant
BSc (Hon) Science Honors, 1996;
HDE Mathematics and Biology,
2000; BSc Environmental and
Cell Biology 1995

Senior review: Dr Brent Baxter
Senior EIA Consultant
PhD University of Natal, BSc Hons, BSc.,
Professional Natural Scientist (Botanical, Environmental
Sciences), Registered Environmental Assessment Professional



APPENDIX A

Waste Inventory from CNOOC (August 2017)

Construction Phase

S.N	Facilities Description	Buildings Area m2	Construction solid waste calculation (*0.05 tons)	Structure Volume m3	Construction solid waste calculation (*0.03 tons)	Remarks
1	CPF	4639.73	232	35364	1061	
2	Wellpads	1320	66	3200	96	Total for FEED phase
3	Permanent Camp	4979.28	249	8503	255	
4	Temporary Camps	14312.79	716	6355	191	Two camps
5	Supply Base	6,309	315	2500	75	
6	Safety Check Station	106.7	5	143	4	
7	Lake Water Intake Pump :	260.09	13	4507	135	
8	Infield lines			936	28	Abandoned soil
			<u>1530</u>		<u>1721</u>	

Decommissioning Phase

S.N	Facilities Description	Buildings Area m2	Decommissioning solid waste calculation (*1.3 tons)	Structure Volume m3	Decommissioning solid waste calculation (*1.6 tons)	Remarks
1	CPF	4639.73	6032	35364	56582	
2	Wellpads	1320	1716	3200	5120	Total for FEED phase
3	Permanent Camp	4979.28	6473	8503	13605	
4	Temporary Camps	14312.79	18607	6355	10168	Two camps
5	Supply Base	6,309	8202	2500	4000	
6	Safety Check Station	106.7	139	143	229	
7	Lake Water Intake Pump :	260.09	338	4507	7211	
8	Infield lines			936	1498	Abandoned soil
			<u>39790</u>		<u>91795</u>	



July 2018

REPORT – VOLUME 4, STUDY 6



CNOOC UGANDA LIMITED

Environmental and Social Impact Assessment for the Kingfisher Development Area in Hoima district, Uganda - Noise Impact Assessment

Submitted to:

The Executive Director National Environment Management Authority, NEMA House,
Plot 17/19/21 Jinja Road, P. O. Box 22255 Kampala, Uganda

Report Number: 1776816-321514-15

Distribution:

- 1 x electronic copy CNOOC Uganda Limited
- 1 x electronic copy NEMA
- 1 x electronic copy Eco & Partner
- 1 x electronic copy Golder





Table of Contents

1.0 INTRODUCTION	2
1.1 Assessment Objectives	2
2.0 TERMS OF REFERENCE.....	2
2.1 Scope of Noise Assessment.....	2
2.2 Study Area and Receptors	2
2.3 Relevant Legislation & Guidelines and Selected Noise Evaluation Criteria	5
2.3.1 Construction Noise.....	5
2.3.1.1 Ugandan Legal Standards.....	5
2.3.1.2 Comparison with IFC Guidelines.....	5
2.3.1.3 Other Construction Noise Guidelines.....	6
2.3.2 Operational Noise	7
2.3.2.1 Ugandan Legal Standards.....	7
2.3.2.2 IFC Guidelines	7
2.4 Selected Noise Evaluation Criteria	7
2.4.1 Adopted Construction Noise Evaluation Criteria	7
2.4.2 Adopted Operational Phase Noise Evaluation Criteria	8
2.5 Method of Prediction of Change	10
2.5.1 ISO 9613	10
2.5.2 Noise Prediction Model Settings.....	10
2.5.3 Scenarios	11
2.5.3.1 Site clearance and construction of infrastructure.....	13
2.5.3.2 Construction of feeder pipeline to Kabaale	14
2.5.3.3 Well Drilling	14
2.5.3.4 Production Operations.....	15
2.5.3.5 Decommissioning and Abandonment	16
2.5.4 Exclusions	16
2.5.5 Cumulative and Trans-boundary Impacts.....	17
3.0 BASELINE NOISE SURVEY	17
3.1 Findings of Baseline Noise Survey.....	19
3.1.1 Kyakapere Village	20
3.1.2 Kyabasambu Village	23





3.1.3	Kingfisher: Pad 1	25
3.1.4	Nsonga (shore)	27
3.1.5	Nsunsu	29
3.1.6	Kiina Village.....	31
3.1.7	Ikamiro Village.....	33
3.1.8	Mid-escarpment	35
3.1.9	Foot of Escarpment.....	37
3.2	Summary of Baseline Noise Levels.....	39
4.0	IMPACT ASSESSMENT	41
4.1	Construction Noise Impact.....	41
4.1.1	Construction Activities Assessed.....	41
4.1.2	Noise Predictions	41
4.1.3	General Construction on the Buhuka Flats.....	41
4.1.3.1	Impacts	41
4.1.3.2	Mitigation.....	45
4.1.4	Drilling of Wells	47
4.1.4.1	Impacts	47
4.1.4.2	Mitigation.....	50
4.1.5	Construction of Feeder pipeline.....	53
4.1.5.1	Impacts	53
4.1.5.2	Mitigation.....	53
4.1.6	Production (Operational) Phase	54
4.1.6.1	Impacts	54
4.1.6.2	Mitigation.....	56
4.1.7	Impact Rating	58
4.1.7.1	Construction Phase (civil construction excluding drilling impacts)	58
4.1.7.2	Construction Phase (civil construction including drilling impacts)	58
4.1.7.3	Construction Phase (Feeder Pipeline)	59
4.1.7.4	Operational Phase	60
5.0	RECOMMENDED CONTINUOUS MONITORING AND ADOPTION OF GOOD PRACTICE	60
5.1	Monitoring programme.....	60
5.2	Noise control measures.....	61
6.0	CONCLUSION.....	61





7.0 REFERENCES 62

TABLES

Table 1: Ugandan Noise at Work Limits.....	5
Table 2: Ugandan Noise Standards compared with IFC Guidelines	6
Table 3: Rio Tinto Impact Rating Scale for Construction Noise for periods longer than 6 months	6
Table 6: Noise Ratings for the Evaluation of Magnitude.....	8
Table 7: Scoring system	9
Table 8: Ranking system	9
Table 9: Baseline Noise Monitoring Locations	19
Table 10: Measured noise levels at NMP2.....	21
Table 11: Measured noise levels at NMP4.....	22
Table 12: Measured noise levels at NMP5.....	24
Table 13: Measured noise levels at NMP6.....	26
Table 14: Measured noise levels at NMP7.....	28
Table 15: Measured noise levels at NMP8.....	30
Table 17: Measured noise levels at NMP10.....	34
Table 18: Measured noise levels at NMP11.....	36
Table 19: Measured noise levels at NMP12.....	38
Table 20: Average Measured Background Noise Levels by Receptor, dB LA90	39
Table 21: Adopted Background Noise Levels by Village, dB LA90	40
Table 22: Household exposure to construction noise during the 3-year construction period and exceedance of daytime and night-time project standard - unmitigated case	44
Table 23: Noise impacts during construction phase	46
Table 24: Household exposure to CPF drilling noise during the 3-year construction period and exceedance of the daytime and night-time project standard – unmitigated case	49
Table 25: Household exposure to drilling noise at well pads 1, 2 , 3 over a 3-year period and exceedance of the daytime and night-time project standard (the plots show combined noise with construction of the CPF) - mitigated case.....	50
Table 26: Noise impacts during drilling phase	52
Table 26: Significance of construction phase noise impact with distance from the pipeline for the daytime period (showing number of affected buildings)	53
Table 27: Noise impacts during production phase	57
Table 28: Construction phase impacts of noise (civil works of CPF complex and associated infrastructure)	58
Table 29: Construction phase impacts of noise (civil works of CPF complex and drilling)	58
Table 30: Construction phase impacts of noise (feeder pipeline).....	59
Table 31: Operational phase impacts of noise (excluding drilling)	60





FIGURES

Figure 1: Kingfisher Development Area	3
Figure 2: Local Study Area	4
Figure 3: Project infrastructure	12
Figure 4: Local study area and baseline noise monitoring locations	18
Figure 5: Measured $L_{Aeq,10min}$ and $L_{A90,10min}$ noise indices at NMP2	20
Figure 6: Kyakapere village, monitoring location NMP2 near foot of escarpment.....	21
Figure 7: Measured $L_{Aeq,10min}$ and $L_{A90,10min}$ noise indices at NMP4	22
Figure 8: Photograph of monitoring location NMP4 at Kyakapere Village with escarpment in distance	23
Figure 9: Measured $L_{Aeq,10min}$ and $L_{A90,10min}$ noise indices at NMP5.....	24
Figure 10: Kyabasambu Village.....	25
Figure 11: Measured $L_{Aeq,10min}$ and $L_{A90,10min}$ noise indices at NMP6.....	26
Figure 12: Photograph of monitoring location NMP6 at Kingfisher 1 Pad	27
Figure 13: Measured $L_{Aeq,10min}$ and $L_{A90,10min}$ noise indices at NMP7	28
Figure 14: Photograph of monitoring location NMP7 at Nsonga	29
Figure 15: Measured $L_{Aeq,10min}$ and $L_{A90,10min}$ noise indices at NMP8.....	30
Figure 16: Photograph of monitoring location NMP8 at Nsunsu.....	31
Figure 17: Measured $L_{Aeq,10min}$ and $L_{A90,10min}$ noise indices at NMP9	32
Figure 18: Photograph of monitoring location NMP9 at Kiina Village.....	33
Figure 19: Measured $L_{Aeq,10min}$ and $L_{A90,10min}$ noise indices at NMP10.....	34
Figure 20: Photograph of monitoring location NMP10 at Ikamiro Village	35
Figure 21: Measured $L_{Aeq,10min}$ and $L_{A90,10min}$ noise indices at NMP11.....	36
Figure 22: Photograph of monitoring location NMP11 on the escarpment.....	37
Figure 23: Measured $L_{Aeq,10min}$ and $L_{A90,10min}$ noise indices at NMP12.....	38
Figure 24: Photograph of monitoring location NMP12 at Nsonga	39
Figure 25: Example of unmitigated civil construction noise showing CPF construction and civil works ongoing simultaneously on Well Pad 3	43
Figure 26: Example of unmitigated drilling noise including CPF construction and drilling on Well Pad 3	48
Figure 27: Noise Levels caused by Production at the CPF (including embedded mitigation indicated in Section 2.5.3.4).....	55

APPENDICES

APPENDIX A

Noise Sources Modelled

APPENDIX B

Baseline – Measured Levels & Graphs

APPENDIX C

Predicted Noise Levels by Receptor

APPENDIX D





Predicted noise contours of construction and drilling phases

APPENDIX E

Predicted noise contours





ABBREVIATIONS AND ACRONYMS

dB(A)	Decibels, A-weighting filter applied
ESIA	Environmental and Social Impact Assessment
EHS	Environmental, Health and Safety
IFC	International Finance Corporation
ISO	International Standards Organisation
m/s	Metres per second
N/A	Not applicable
UKAS	United Kingdom Accreditation Service

GLOSSARY

L_{Aeq}	the value of the A-weighted sound pressure level in decibels of continuous steady sound that is within a specified time interval, T, has the same mean-squared sound pressure as a sound that varies with time
L_{A90}	the A-weighted sound pressure level which is that exceeded for 90% of the measurement period, indicating the noise level during quieter periods, and is often referred to as the background noise level
dB	Decibel. Acoustic unit used to quantify sound levels relative to a 0 dB reference (20 micropascals sound pressure), set at the typical threshold of perception of an average human.





1.0 INTRODUCTION

1.1 Assessment Objectives

This assessment considers the potential noise impacts arising from the proposed CNOOC project (the Project) in the Kingfisher exploration field on the shore of Lake Albert, Uganda and supersedes a previous version completed by Golder in June 2014. Noise impacts are considered in the context of appropriate guidelines and with reference to noise levels measured during a baseline survey in the study area.

In order to assess the noise impacts associated with the Project, multiple stages of its development have been considered. Where significant noise impacts have been identified at noise-sensitive receptors, mitigation has been considered and specified in order to reduce the significance of predicted impacts to an acceptable level.

2.0 TERMS OF REFERENCE

2.1 Scope of Noise Assessment

The scope of the noise assessment has been determined by making reference to the Scoping Report (Ref. 1) and the Development Plan (Ref. 2) and the Project Description. The primary aims of the noise assessment are:

- To identify receptors which may be sensitive to changes in the ambient noise environment;
- To determine appropriate criteria by which to assess changes to noise levels arising as a result of the Project;
- To predict the noise levels at identified receptors as a result of the different stages of the Project and assess these against the adopted criteria; and
- To provide suggested mitigation where unacceptable impacts are identified.

2.2 Study Area and Receptors

The Kingfisher Field lies on the south flank of the Albert Basin, part of the western arm of the East African Rift System. The location of the Kingfisher Development Area (KDA) is indicated in Figure 1 and the Local Study Area (LSA) for the noise assessment is provided in Figure 2.



NOISE IMPACT ASSESSMENT

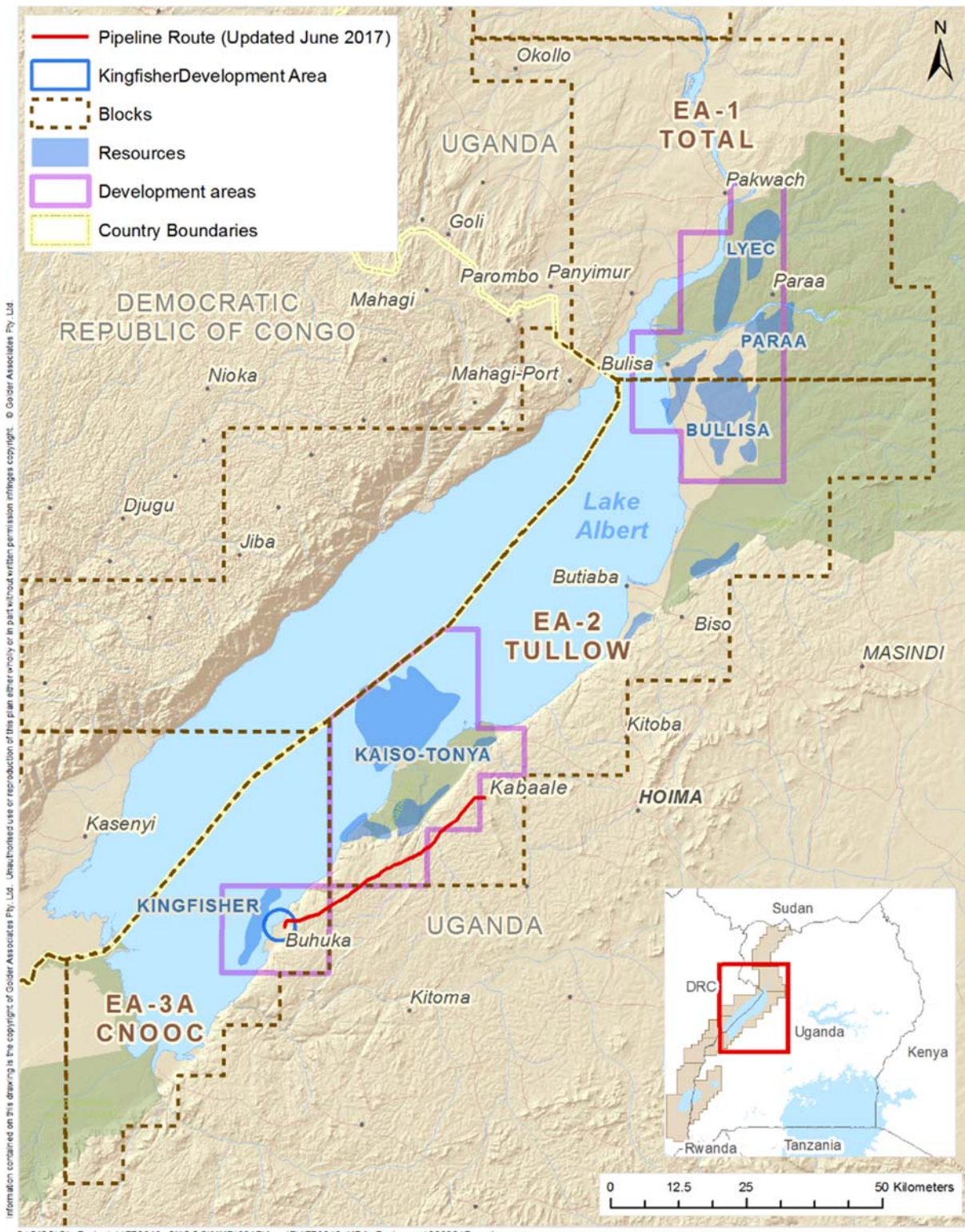

Figure 1: Kingfisher Development Area



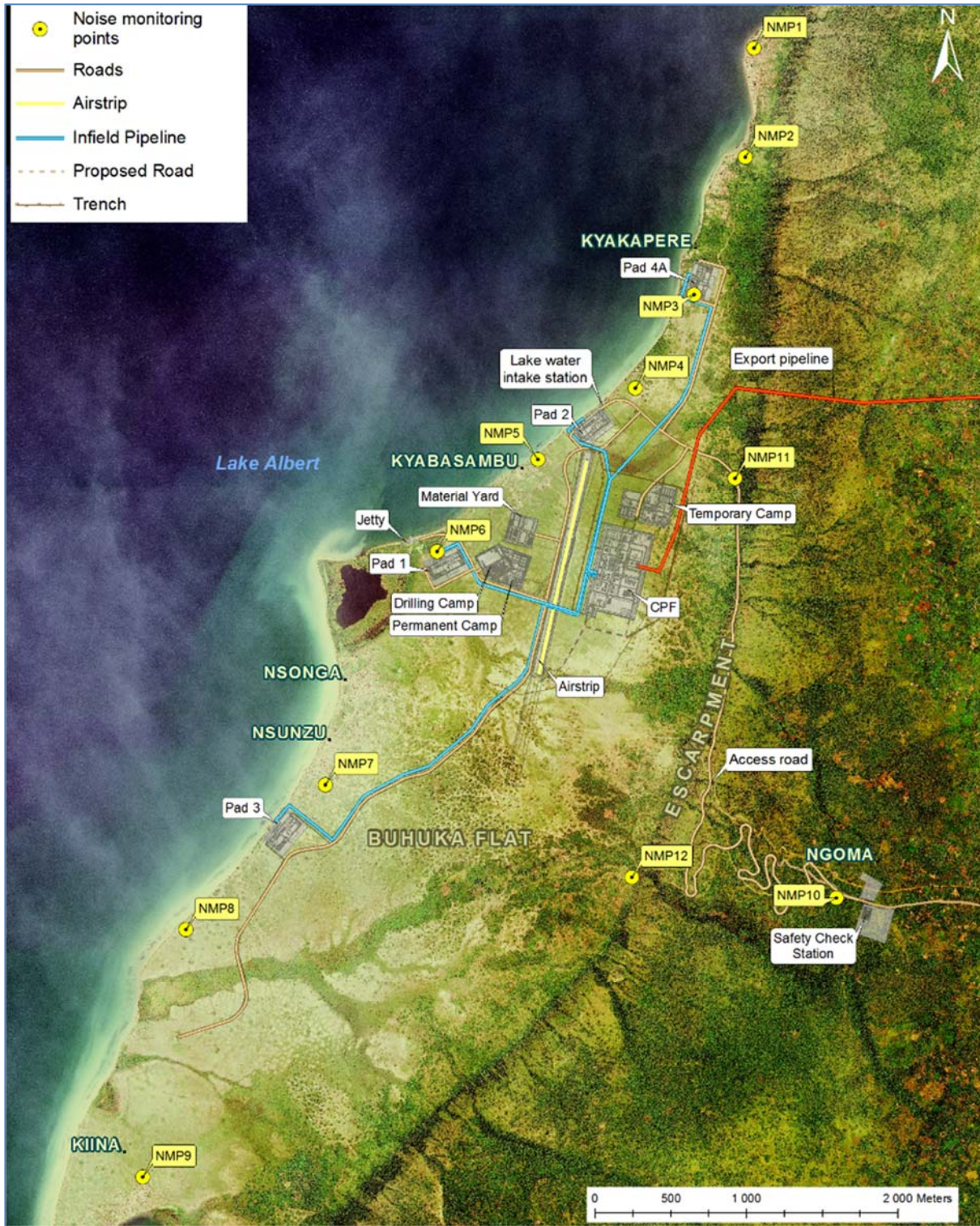

Figure 2: Local Study Area



The Project will comprise a range of oil-producing and supporting facilities including 31 wells comprising 20 production wells and 11 produced water injection wells, located at 4 well-pads, and associated infrastructure including; Central Processing Facility (CPF), production flow line, water injection flow line, oil feeder pipeline, lake water extraction station, workers' camps, a jetty, an airstrip and service roads.

2.3 Relevant Legislation & Guidelines and Selected Noise Evaluation Criteria

2.3.1 Construction Noise

2.3.1.1 Ugandan Legal Standards

Ugandan legislation relevant to this assessment is set out in the document 'National Environment (Noise Standards and Control) Regulation, 2003' (the Regulations) (Ref. 3). More recent regulations (dated 2013) are in Draft form (The National Environment (Noise and Vibrations Standards and Control) Regulations, 2013) (Ref. 4).

There are considerable differences in the legal and guideline values for construction noise. The Ugandan construction noise standard is the same in both the 2003 and the Draft 2013 regulations (Table 7-12). Daytime noise at locations other than highly noise-sensitive land uses such as hospitals, schools, institutions of higher learning (i.e: most development on the Buhuka Flats) should not exceed 75 dBA during the day and 65 dBA at night. For sensitive land uses, a noise level of 60 dBA during the day and 50 dBA at night applies. Noise levels are energy averages (quoted as LAeq).

The Ugandan noise regulations also provide limits for noise for the protection of workers within workshops and industrial installations. These are provided in Table 1. The maximum occupational exposure limits have been referenced in identifying source noise terms for proposed plant.

Table 1: Ugandan Noise at Work Limits

Receptor Type	Noise Limit, dB LAeq
Offices	50
Factory/Workshop Compound	75
Factories/Workshops	85

Any owner of a facility which produces noise that exceeds the standards set out in the Ugandan noise regulations is required to apply to for a License in terms of Part IV.

2.3.1.2 Comparison with IFC Guidelines

The Ugandan legal standard is less stringent than the IFC guidelines, which specify target noise levels not exceeding a daytime limit of 55 dBA and a night-time limit of 45 dBA, as well as the requirement that sound levels should not be increased by more than 3 dBA above the background ambient. The IFC guidelines are not specifically designed for construction (temporary) noise and achieving less than a 3 dBA increment under construction conditions is not easily achievable. In the context of construction noise, the IFC 3 dBA criterion is often interpreted to apply only in cases where the baseline ambient already exceeds the IFC maxima specified Table 2.





Table 2: Ugandan Noise Standards compared with IFC Guidelines¹

Period	IFC	Ugandan Construction Noise Standard (2003)	Draft (Revised) National Ugandan Construction Noise Standard (2013) ²
Daytime Noise	55 dBA	75 (60)*	75 (60)
Night-time Noise	45 dBA	65 (50)	65 (50)

* numbers in brackets refer to noise-sensitive land uses such as hospitals and schools

The daytime period in the Ugandan Regulations is defined as 06:00 to 22:00, compared with the IFC's 07:00 to 22:00. This is more conservative than the IFC guidelines, since the lower night-time noise limit applies for a longer period;

2.3.1.3 Other Construction Noise Guidelines

Other noise guidelines designed specifically for construction noise impact distinguish between noise levels based on the period of construction. One of the most cogent of these is Rio Tinto's 'Noise and Vibration Criteria Impact Assessment Criteria and Methodology'³ (Table 3). This guideline rates the significance of construction noise on the basis of the period of time over which it occurs (short term <1month, medium term 1-6 months, long term >6 months). For long term construction noise (>6 months), the target values are an L_{Aeq(1hr)} of 55 dBA (daytime) and 45 dBA (night-time). For construction periods lasting between 1-6 months, the daytime target values are an L_{Aeq(1hr)} of 65 dBA. Night-time values for the 1-6 month period do not apply to the present project. Noise levels below these values are considered to be insignificant. Impact significance ratings based on these threshold values are shown in Table 3 and Table 4.

Table 3: Rio Tinto Impact Rating Scale for Construction Noise for periods longer than 6 months⁴

Time of Day	Noise Level (dB LAeq, 1 hr)					
	<45	45-50	50-55	55-60	60-65	>65
Daytime	NS	NS	NS	Minor	Moderate	Major
Night time	NS	Minor	Moderate	Major	Major	Major

NS = Not significant

Table 4: Rio Tinto Impact Rating Scale for Construction Noise for 'medium term' periods of 1- 6 months⁵

Time of Day	Noise Level (dB LAeq, 1 hr)						
	<45	45-55	55-60	60-65	65-70	70-75	>75
Daytime	NS	NS	NS	NS	Minor	Moderate	Major

NS = Not significant

¹ This assessment assumes that the reference time over which L_{Aeq} levels are averaged is 1 hour, as is common to most international guidance and legislation for environmental noise.

² Draft National Environment (Noise and Vibrations Standard and Control) Regulations, 2013: Schedule 4 Part A. the quoted standard is

³ Rio Tinto (undated)

⁴ Ibid

⁵ Ibid





2.3.2 Operational Noise

2.3.2.1 Ugandan Legal Standards

Ugandan legislation relevant to this assessment is set out in the 2003 Regulations. These regulations describe the maximum permissible noise levels from a facility in different environments. Part II (6) 1 sets out the noise levels that should not be exceeded for different types of land use in the ‘general environment’ The ‘Levels for the General Environment’, broken down by receptor sensitivity, are provided in Table 5. In Part III Section 8 of the Draft (2013) regulations, it is specified that noise impacts shall not exceed the levels prescribed under these Regulations or result in a maximum increase in background levels of 3 dB at the nearest receptor location off-site.

The environment on the Buhuka Flats presently falls within Category C of Table 5,

Table 5: Ugandan Environmental Noise Limits

Category	Receptor Type	Noise Limit, dB L _{Aeq}	
		Daytime (06:00 – 22:00)	Night-time (22:00 – 06:00)
A	Any building used as hospital, convalescence home, home for the aged, sanatorium, institute of higher learning, conference rooms, public library, environmental or recreational sites.	45	35
B	Residential buildings	50	35
C	Mixed residential (with some commercial and entertainment)	55	45
D	Residential and industry or small-scale production and commerce	60	50
E	Industrial	70	60

This assessment assumes that the reference time over which L_{Aeq} levels are averaged is 1 hour, as is common to most international guidance and legislation for environmental noise.

2.3.2.2 IFC Guidelines

The IFC noise guidelines are described in Table 2 above. Target noise levels not exceeding a daytime limit of 55 dBA and a night-time limit of 45 dBA are specified as well as the requirement that sound levels should not be increased by more than 3 dBA above the background ambient.

2.4 Selected Noise Evaluation Criteria

2.4.1 Adopted Construction Noise Evaluation Criteria

The Rio Tinto guidelines are used in this assessment due to the detailed differentiation between construction periods of different lengths. The Rio Tinto targets in Table 3 (period longer than 6 months) can be regarded as a basis for impact assessment for the civil construction at the CPF, the drilling and the feeder pipeline personnel camp, being more stringent than the Ugandan regulations, which are legally defined maxima. The assessment of noise caused by the construction of the feeder pipeline is evaluated in accordance with Table 4, which is based on the Rio Tinto guidelines for construction noise which extends over a period of between 1-6 months.





To adapt the CNOOC ESIA impact rating scale to conform to the above approach, the standard impact rating criteria are not applied. The ratings of 'minor', 'moderate' and 'major' in Table 3 and Table 4 are deemed to be equivalent to 'low', 'medium' and 'high' significance in the CNOOC ESIA rating scale.

2.4.2 Adopted Operational Phase Noise Evaluation Criteria

For the operational phase, the criteria used to evaluate the significance of potential noise impacts follows the general rating system defined for the ESIA. This includes:

Direction of an impact may be positive, neutral or negative with respect to the particular impact. A positive impact is one which is considered to represent an improvement on the baseline or introduces a positive change. A negative impact is an impact that is considered to represent an adverse change from the baseline, or introduces a new undesirable factor.

Magnitude is a measure of the degree of change in a measurement or analysis, and is classified as none/negligible, minor, low, medium or high. The magnitude of impact interpreted on the basis of noise-related criteria is shown in Table 6.

Table 6: Noise Ratings for the Evaluation of Magnitude

Table with 3 columns: Criterion, Rating, Definition. Rows include Magnitude categories: No Significant Impact, Minor, Low, Medium, High.

Duration refers to the length of time over which an environmental impact may occur: i.e. transient (less than 1 year), short-term (1 to 5 years), medium term (6 to 15 years), long-term (greater than 15 years with impact ceasing after closure of the project) or permanent. Noise generated by plant and equipment at the CPF will be long term.

Scale / Geographic extent refers to the physical area that could be affected by the impact and is classified as indicated below into site, local, regional, national, or international. All noise-related impacts will be local or site based in scale.

Site: impacts that are limited to the direct area of disturbance and immediate surrounds

Local: impacts that affect an area in a radius of up to 10 km around the site

Probability of Occurrence is a measure of the likelihood of the change (or impact) actually occurring. This may be categorised as:

No chance of occurrence 0% chance of change;





Improbable	less than 5% chance;
Low probability	5% to 40% chance;
Medium probability	40 % to 60 % chance;
Highly probable	60% to 90% chance; or
Definite	impact will definitely occur.

A simple scoring system is applied in line with the example provided in Table 7 below.

Table 7: Scoring system

Magnitude	Duration	Scale	Probability
10 Very high/ don't know	5 Permanent	5 International	5 Definite/don't know
8 High	4 Long-term (impact ceases after closure of activity)	4 National	4 Highly probable
6 Medium	3 Medium-term (5 to 15 years)	3 Regional	3 Medium probability
4 Low	2 Short-term (0 to 5 years)	2 Local	2 Low probability
2 Minor	1 Transient	1 Site only	1 Improbable
1 None/Negligible			0 No chance of occurrence

The significance of the change (impact) is then be determined as:

$$SP \text{ (Significance Points)} = (\text{Magnitude} + \text{Duration} + \text{Extent}) \times \text{Probability}$$

where the relative significance of the change (or impact) is typically ranked as set out in Table 8 below.

Table 8: Ranking system

Value	Significance	Implications for the Project
SP ≥75	Indicates high environmental and/or social significance	The degree of change (or impact) that the Project may have upon the environment and/or the community(s) is unacceptably high. High residual impacts carry substantial weight for authority decision making about the project. The impact must be mitigated or avoided. If this impact cannot be mitigated or avoided, the Project is unlikely to be permitted for development.
SP 30 - 75	Indicates medium environmental and/or social significance	The degree of change (or impact) that the Project may have upon the environment and/or the community(s) is medium. The Project may be compromised if this residual impact cannot be avoided or sufficiently mitigated
SP ≤30	Indicates low environmental and/or social significance	The degree of change (or impact) that the Project may have upon the environment and/or the community(s) is relatively low. Opportunities to avoid or mitigate the impact should still be considered, however this should not compromise the viability of the Project.





Value	Significance	Implications for the Project
+	Positive impact	The changes will have a positive benefit upon the existing environment and/or the community(s).

2.5 Method of Prediction of Change

2.5.1 ISO 9613

In order to determine the specific noise levels attributable to the Project, a noise propagation model was created within the proprietary noise prediction software, CadnaA, and the predicted noise levels compared with the measured noise levels at each receptor. All noise propagation within the model was calculated in accordance with ISO9613 *Parts 1 & 2 Acoustics - Attenuation of sound during propagation outdoors*.

The propagation model described in the ISO standard provides for the prediction of sound pressure levels based on down-wind (i.e. worst-case) conditions and other conditions favourable for noise propagation. The model calculates the predicted sound pressure level by taking the SWL for each turbine in separate octave bands and subtracting a number of attenuation factors, according to the following:

$$\text{Predicted Octave Band Noise Level} = L_w - A$$

Where L_w is the octave band sound power level and A represents the various attenuation factors, also in dB. A is defined as:

$$A = A_{div} + A_{atm} + A_{gr} + A_{bar} + A_{mis}$$

A_{div} is the attenuation due to geometric divergence. This is the reduction in noise levels caused by the spherical spreading of the noise over distance from the point source. The attenuation factor therefore increases as the distance from the noise source increases.

A_{atm} is the atmospheric absorption of the noise in the atmosphere as sound energy is converted to heat. The level of absorption varies depending on the distance from source and the atmospheric conditions (temperature and humidity). ISO 9613-1, *Acoustics Attenuation of Sound during Propagation Outdoors: Part 1 - Method of calculation of the attenuation of sound by atmospheric absorption* provides appropriate air attenuation factors for differing atmospheric conditions.

A_{gr} is the ground attenuation factor and represents the reduction in noise levels due to the absorption and reflection of sound energy by ground cover. The ground attenuation will vary significantly depending on the absorptive qualities of the ground cover. ISO9613-1 provides advice on appropriate ground attenuation factors based on ground cover ranging from hard ground (concrete) to soft absorbent ground.

A_{bar} relates to the attenuation due to the screening and reflection effects provided by obstacles between the source and the receiver. The level of attenuation will vary depending on the degree by which the line of sight between source and receptor is affected and the frequency considered.

A_{mis} represents any miscellaneous causes of attenuation.

2.5.2 Noise Prediction Model Settings

Reported atmospheric conditions in the local area based on internet research fall within the temperature range 9°C – 32°C with a relative humidity (RH) of 88%. The attenuation effect on noise propagation is inversely proportional to air temperature; the higher the temperature and humidity the greater the atmospheric attenuation of noise. Noise predictions have therefore assumed a worst-case air temperature of 10°C and 70% RH.

Ground conditions in the study area, determined from an examination of aerial imagery and ground investigations by the wider Golder team, comprise of a mix of cleared agricultural areas, wetlands and woodland. A ground absorption factor of $G=0.5$ representative of mixed ground (i.e. non-developed,





moderately reflective) has been used within the model. Localised areas of ground absorption factor $G=0$ (such as large water bodies or hard, reflective surfaces) have been assumed within the Project area for the surface of Lake Albert. The Kingfisher Field is predominantly flat-lying in the vicinity of the majority of Project infrastructure, however, topographic contours of the area have been included within the model in order to account for any screening effects of topography.

2.5.3 Scenarios

The Project will comprise 5 distinct scenarios or phases of activity; site clearance and construction of infrastructure, construction of the feeder pipeline, well drilling, production, and decommissioning / abandonment. Some of the ancillary project infrastructure has already been licensed and built. The main road down the escarpment into the project area is in place. Project access roads to the northern end of the CPF boundary and to well pads 1, 2 and 3 are in place. The well pads have been partly cleared and developed for the exploration drilling which has taken place to date. The drilling camp is fully established and fenced and the supply base is cleared and fenced and is partly developed to support exploration activities. The airfield is presently a grass strip, developed to its full length. A jetty has been built for importing equipment and materials for exploration, although this will need to be upgraded.

The activities, plant assemblages and assumptions made in the prediction of noise levels of the 5 identified phases are set out below.

The noise prediction models of each scenario provide snap-shots of the activities which will be undertaken during the lifetime of the Project. In each model the 'worst-case' has been assumed, whereby the stage of works considered to have the greatest potential impact has been modelled. The noise sources modelled and their assumed sound power levels for operations for each phase of the Project are provided in APPENDIX A.

The infrastructure associated with the Project is shown in Figure 3.



NOISE IMPACT ASSESSMENT

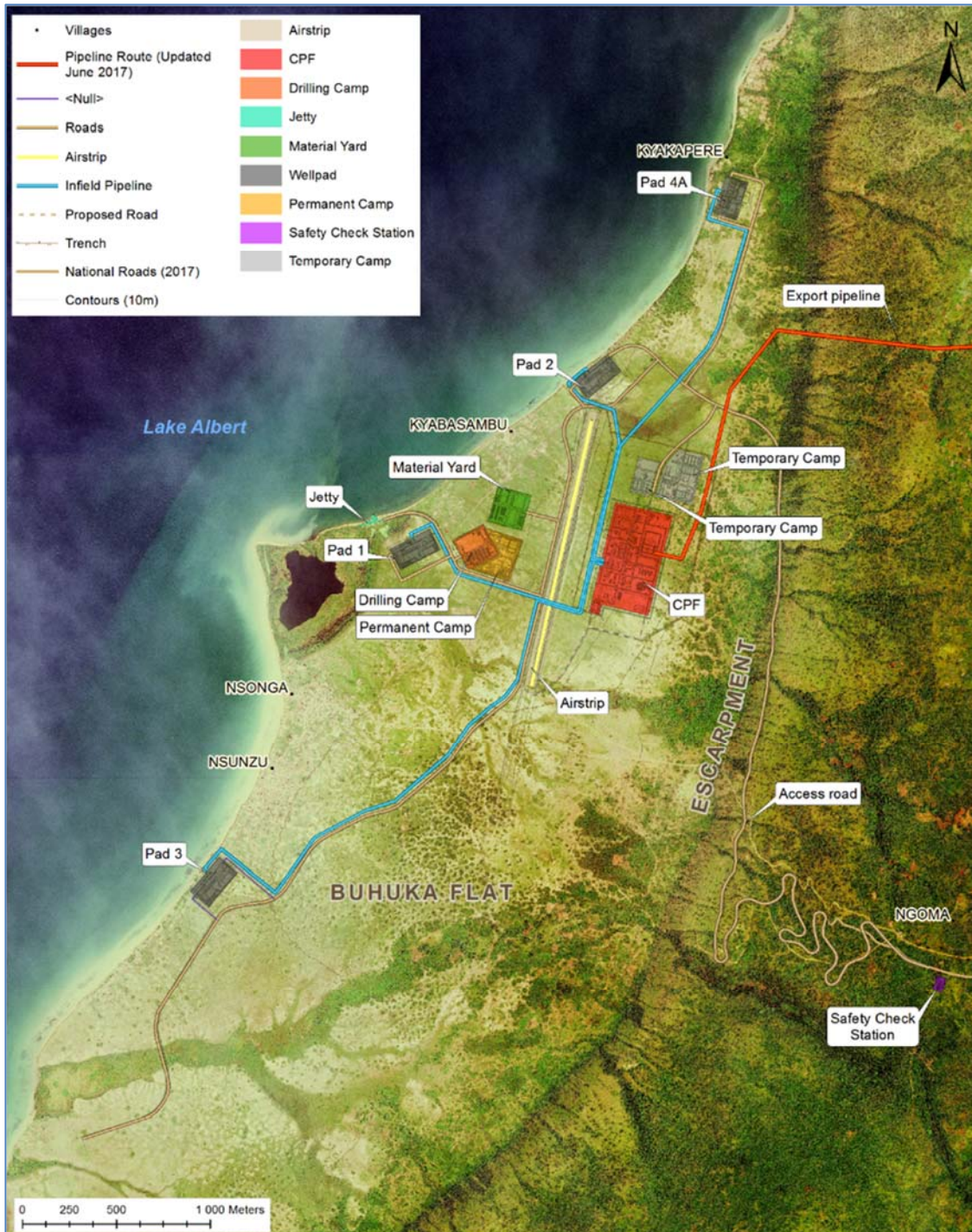

Figure 3: Project infrastructure





2.5.3.1 *Site clearance and construction of infrastructure*

It is anticipated that the construction of Project infrastructure, such as roads, the central processing facility (CPF) and the upgrade of existing facilities and camps will be completed prior to the commencement of drilling.

The pre-drilling construction work will comprise the following:

- Upgrade and improvement of existing facilities and camps;
- Clearance, levelling and construction of CPF;
- Clearance, excavation and laying of injection pipelines and flowlines;
- Final clearance of Well Pads 1,2 and 3, including expansion to their full extent, clearance and levelling of proposed Well Pad 4-A;
- Excavation of drainage;
- Jetty construction and upgrade.

Source noise terms for items of construction plant were obtained from British Standard BS 5228 (Ref. 6). BS 5228 provides recommendations for control of noise from construction and open sites and includes an annex which provides measured noise levels from a wide range of construction plant and activities.

The noisiest stage of the construction works has been assumed to be clearance and construction works at the well pads, CPF and the laying of pipelines. Such works typically generate higher levels of noise than fabrication and finishing works, since greater numbers of heavy mobile plant are required. CNOOC have confirmed that no noisy construction works will be undertaken during the night-time period at the CPF; this assessment therefore assumes that night-time activities will be restricted to use of hand tools and assembly activities, and no heavy plant will be used. During construction of the feeder pipeline, no construction activities at all will be undertaken during the night-time period. The construction phase of the CPF and supporting infrastructure will involve the following general activities:

- Clearing, levelling and terracing
- Foundations and civil construction works
- Installation of Equipment
- Electrical and other tie ins
- Commissioning and testing of plant and equipment

The construction sites will involve a multitude of activities, employing up to 1,173 personnel (including day workers) at peak times. Cranes, excavators, bulldozers, heavy vehicles, vibrating rollers, and a wide range of other mechanical and hand-operated equipment will be used. Most of the activity will be restricted to within defined work areas, the principal of these being the CPF and permanent camp, as well as ancillary work areas which will include road construction sites (not already completed), the water intake station, the jetty (upgraded) and the airfield (upgraded).

An assemblage of mobile plant comprising excavators, dump trucks and bulldozers has been assumed, based on typical requirements of site clearance activities. Mobile plant items have been assumed to have a utilisation of 80 percent.

Road upgrade and construction in the Kingfisher Field, along with associated extraction of rock from the borrow pits and crushing at the crushing plant have been completed prior to the commencement of the Project and were considered in the road ESIA. These activities have therefore been excluded from this assessment.





The construction phase has been modelled assuming works will take place at each worksite (CPF, Well Pad 1, Well Pad 2, Well Pad 3 and Well Pad 4A) sequentially, rather than simultaneously. A representative assemblage of plant, comprising two excavators, two road wagons, a dozer, a crane and a vibrating roller has been modelled at each worksite and noise levels predicted at the closest receptors to the worksite.

All source noise terms for construction plant and activities have been obtained from BS5228. Details of the modelled noise sources are provided in Appendix A.

2.5.3.2 Construction of feeder pipeline to Kabaale

It has been assumed that the feeder pipeline to Kabaale will be constructed in 1 km long stages, with each stage of work occurring sequentially. Rather than model each 1 km stage, noise levels from the activities associated with pipeline construction; clearing, excavating, laying pipe, welding and backfilling, have been predicted for a single 1 km stretch, and impacts evaluated at a range of stand-off distances from the works. A representative assemblage of plant associated with pipeline construction, comprising two dozers, two large excavators, two cranes, two low-loading trucks and two sets of welding plant has been assumed. Noise levels have been predicted at stand-off distances of 10 m, 50 m, 100 m and 200 m from the pipeline construction works.

2.5.3.3 Well Drilling

Drilling of wells at one well pad may be undertaken while construction works and production activities continue at other well pads. An activity schedule for the project programme has been provided, indicating that well drilling is anticipated to start in 2019 at Well Pad 2. The programme further notes that drilling activities will move sequentially between well pads in the following order:

- Well Pad 2 (171 days);
- Well Pad 3 (184 days);
- Well Pad 1 (157 days);
- Well Pad 2 (220 days);
- Well Pad 1 (137 days);
- Well Pad 3 (341 days);
- Well Pad 2 (169 days); and finally
- Well Pad 4A (460 days).

CNOOC proposes to use a single drill, with identified drill components and supporting equipment indicated to comprise the following:

- Drilling rig; comprising draw-works and top drive;
- Mud pumps x3;
- Tank system;
- Pressure control; and
- Diesel generators.

Sound power levels for the drill rig, equivalent to the proposed plant listed above, have been obtained from published noise levels available freely online. Source noise terms for items of plant for which no source noise terms were available were obtained from typical levels for construction plant published in BS 5228.

The drill rig comprises two principal noise sources; the engine, including hydraulic pumps and exhaust, which is located close to ground level, and the top drive, which moves from the top of the rig towards the ground as the well advances. The assumed sound power levels of the rig engine and the top drive are 111 dB(A) and 106 dB(A) respectively. The top drive has been modelled as a noise source at the top of the rig mast, 45 m above ground level. The engine and all items of ancillary plant have been assumed to have an effective source height of 2 m above ground level.



Ancillary plant such as mud pumps and generators have been assumed to have an on-time (utilisation) of 100 percent. Drill rig utilisation has been assumed to be 85 percent to allow for downtime and operations such as the addition and removal of drill rods to the drill string which will not require full power. Noise levels have been predicted for each well pad individually.

In later stages of the Project drilling will occur at some well pads while production is occurring at others. Concurrent drilling and production represents “worst case”, therefore throughout the drilling phase the CPF has been assumed to be operational, with all items of fixed plant running with an on-time of 100 percent. As production increases, it is expected that noise levels from the CPF will also increase, however, a worst-case scenario of maximum CPF utilisation has been assumed from the start of the drilling phase.

2.5.3.4 *Production Operations*

The project description notes that first production will mark the start of the operational phase, and that this will overlap with continued construction and drilling of wells for the first 5 years. To consider the worst-case, this assessment considers operations at the CPF in parallel with drilling at well pads. All fixed plant at the CPF is assumed to have a utilisation of 100%, with the exception of the flare, which will operate only during purge and non-routine operations, and has therefore been excluded from this study. The production stage is anticipated to be approximately 25 years.

CNOOC proposes that, on completion of drilling, the operation of well pads will be automated; the presence of operatives at well pads will therefore not be required. Noise from vehicle traffic in the LSA has therefore been assumed to be not significant and has been excluded from this assessment. The majority of the equipment associated with production will be located at the CPF and noise sources at the well pads will be limited.

The CPF will comprise the following items of fixed plant and assemblages of plant:

- Water treatment plant;
- 4 x 16 MW gas turbine generators (3 operational, 1 standby) and substation for power generation;
- Excess gas utilisation package;
- Oil separation plant;
- Fuel gas and flash gas compressors;
- Water injection pumps;
- Pumps and heating for oil transmission system; and
- Emergency flares.

Well pads will comprise the following items of fixed plant:

- Wellhead apparatus;
- Injection and production manifolds;
- Transformer and substation;
- Chemical injection skid; and
- Wellhead control panel.

During the production stage, at both the CPF and the well pads it is considered that items of mobile plant may be required for maintenance purposes. Such activities will be infrequent and of short duration and have therefore been assumed to be not significant.



Source noise terms for items of fixed plant at the well pads and CPF were not available at the time of this assessment; however, CNOOC has undertaken to comply with Ugandan regulations for the protection of employees' hearing. The daily permissible noise level for workers at a factory or workshop is 85 dBL_{Aeq,8hr}, which does not take hearing protection into account. It has therefore been assumed that no single item of plant at the CPF will have a sound pressure level exceeding 80 dB(A) at 1 m, in order that several such items operating simultaneously in close proximity will not exceed 85 dB(A) at a given receiver, assuming that hearing protection will not be required at the CPF or well pads during the production phase. A sound pressure of 80 dB(A) at 1 m corresponds to a sound power level of 91 dB(A) for a point source operating under free-field conditions. All noise sources at the CPF have been assumed to have an effective height of 2 m above ground level.

During production, noise from plant at the well pads is anticipated to be minimal. CNOOC has confirmed that noise from the well pads during production will not exceed 3 dB above the measured baseline when measured at the boundary of the well pad. Should noise levels due to production operations exceed the measured baseline by more than 3 dB noise attenuation will be fitted to the noisiest items of plant until this condition is met.

CNOOC proposes to limit noise emissions from the CPF by installation of acoustic enclosures where protection of the workforce is required, however, no details of any such mitigation has yet been specified. This assessment assumes that acoustic enclosures will limit the sound pressure level from any single noise source to 80 dB(A) at 1 m in order to meet the workforce protection requirements. Other measures proposed as part of the current Project design which may mitigate noise propagation include the placement of a 200 m exclusion zone around the CPF.

2.5.3.5 Decommissioning and Abandonment

Decommissioning activities are anticipated to comprise dismantling, decontamination and removal of process equipment and facility structures and remediation activities. The following works have been identified for this stage of the Project:

- Removal of production/injection wells and well pads;
- Excavation and removal of field flow lines;
- Decommissioning, demolition and removal of CPF;
- Demolition and removal of accommodation; and
- Removal of other infrastructure.

The decommissioning phase is anticipated to include activities and plant items similar to those used in the construction phase. No additional noise predictions have been undertaken for the decommissioning phase, as noise levels and associated impacts are assumed to be the same as those identified for the construction of infrastructure phase.

2.5.4 Exclusions

This assessment assumes that the airstrip will be decommissioned and that helicopter flights will be infrequent; a worst-case comprising a maximum of 1 flight per day, occurring during daylight hours. Noise from aircraft has therefore been excluded from this assessment.

No information was available regarding the flow of traffic on Project roads. This assessment has included traffic movements during the construction stage only, when material will be transported to and from the stockpile areas. Road traffic during the drilling and production stage of the Project has been assumed to be infrequent and therefore not significant.

This assessment assumes that Project-related boat traffic from the new jetty will mostly be inaudible at human receptors. Project-related boat movements have been assumed to be infrequent and to not contribute significantly to total boat movements on the lake.





2.5.5 Cumulative and Trans-boundary Impacts

Golder is not aware of any nearby projects which have the potential to generate cumulative noise effects. No cumulative effects have therefore been considered within this assessment. The Democratic Republic of Congo (DRC) lies on the opposite shore of Lake Albert, however, given the 40 km distance to the nearest DRC receptors, noise from the Project will not be audible and is therefore not considered further.

3.0 BASELINE NOISE SURVEY

A baseline noise survey was undertaken in March 2014. Ambient noise measurements were conducted at communities within the LSA and at other potentially noise-sensitive locations in the vicinity of the Project. Potentially noise-sensitive receptors were identified using aerial imagery and digital maps of the study area prior to commencement of monitoring. The chosen locations are shown in Figure 4 and listed in Table 9, along with justification for their selection.



NOISE IMPACT ASSESSMENT

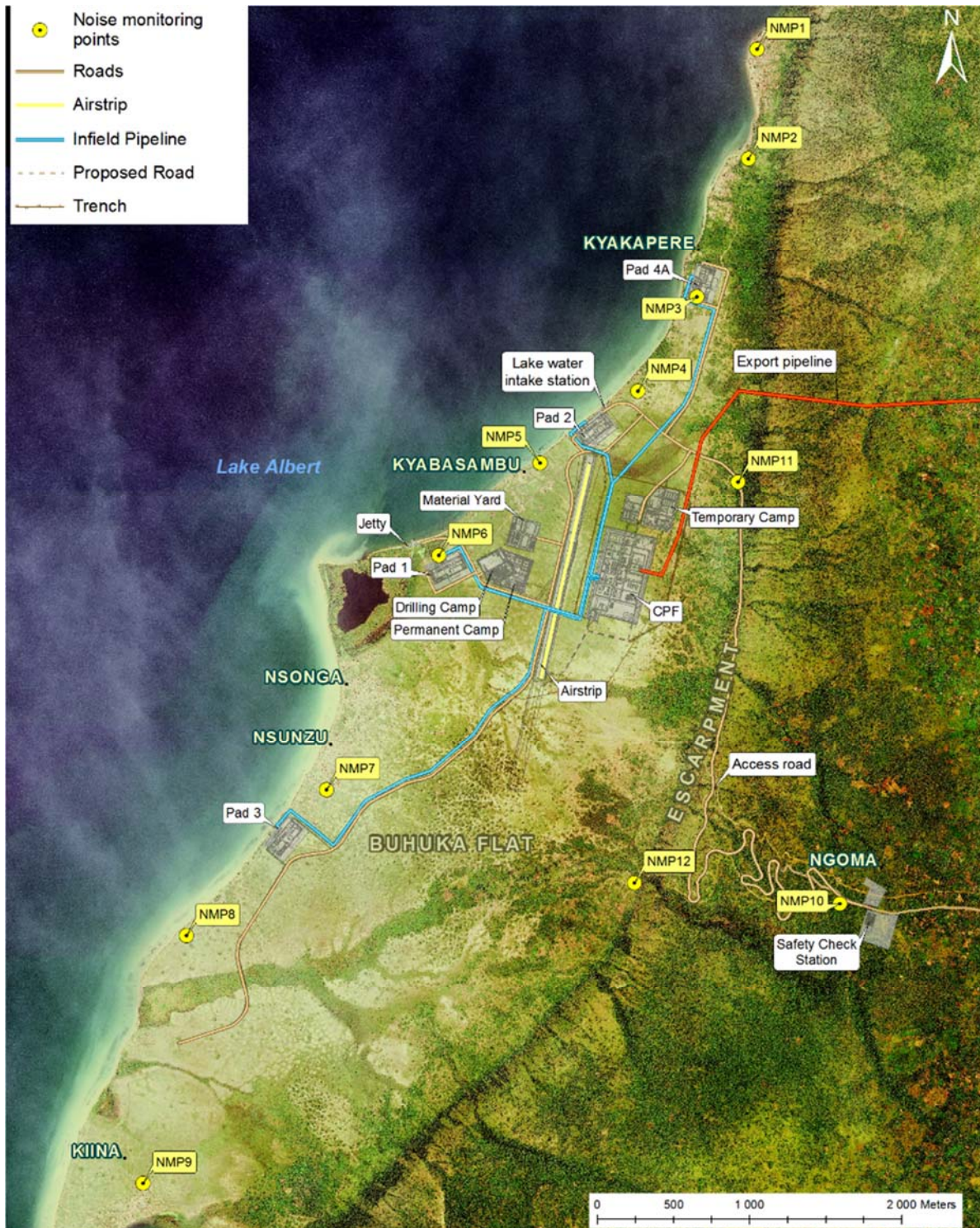

Figure 4: Local study area and baseline noise monitoring locations





Table 9: Baseline Noise Monitoring Locations

Monitoring Name	Location	Monitoring Location Number	UTM grid coordinates		Justification
			X	Y	
Kyakapere Village		NMP1	250685	141300	Village; proximity to Well Pad 4-2*
Kyakapere Village		NMP2	250627	140581	Village; proximity to pipeline*
Kyakapere Village		NMP3	250289	139667	Village; proximity to pipeline
Kyakapere Village		NMP4	249900	139051	Village; proximity to Well Pad 2
Kyabasambu Village		NMP5	249256	138576	Village; proximity to Well Pad 2
Kingfisher 1 Pad		NMP6	248591	137965	Currently derelict, close to village
Nsonga		NMP7	247851	136417	Village; proximity to Well Pad 3
Nsunsu		NMP8	246929	135460	Village; proximity to Well Pad 5*
Kiina Village		NMP9	246643	133827	Village; proximity to Well Pad 5*
Ikamiro Village		NMP10	251229	135669	Village; proximity to storage yard
Inland, mid-escarpment		NMP11	250559	138450	Isolated farms; proximity to CPF
Inland, foot of escarpment		NMP12	249877	135806	Proximity to borrow pit

Note – In the latest design of the Project, Well Pad 4-2 has been replaced by Well Pad 4A and Well Pad 5 is no longer proposed, therefore some baseline monitoring locations are no longer close to proposed project infrastructure. All measured data is reported here in the interests of completeness.

At Kyakapere Village monitoring was undertaken at four locations; at NMP2 and NMP4, 24-hour surveys were completed. In order to confirm that these long-term measurements were representative of the character of this elongated settlement, spot measurements were undertaken for 1 hour during the daytime and 1 hour during the night-time period at NMP1 and NMP3.

Monitoring was undertaken in accordance with international guidelines ISO 1996-1:2003 Part 1 (Ref. 6) using two Norsonic Nor-131 Class 1 sound level meter (SLMs). The SLMs were commissioned in environmental monitoring kits, comprising a power supply, a microphone protection assembly and a hard case to protect the instrument. SLMs were field calibrated before and after each measurement.

In compliance with IFC EHS guidelines, monitoring equipment was located at least 3 m away from any vertical sound-reflecting surfaces (e.g. walls) and at a height of approximately 1.5 m above ground level. All noise measurements were undertaken in external free-field locations, therefore negating interference of vertical reflective surfaces.

Ikamiro Village was included within the baseline survey due to its proximity to the access road. We understand that the road has now been completed, however, Ikamiro has been used as a proxy baseline location for evaluation of noise due to construction of the feeder pipeline.

3.1 Findings of Baseline Noise Survey

The L_{A90} noise parameter is typically considered to be representative of the steady ‘background’ noise level because it is less affected by short-term noisy events, which may not be representative of prevailing conditions, than the L_{Aeq} ‘ambient’ parameter.

The baseline measurements were conducted using a 10-minute averaging period, in order to provide sufficient resolution to characterise the variability of the ambient and background noise levels throughout the 24-hour monitoring period. For the purposes of the baseline characterisation the 10-minute values have been referred to. In the assessment, however, hourly averages have been adopted in accordance with international best practice.

Analysis of the baseline monitoring data from the 12 survey locations indicated the following:





- Measured noise levels were broadly consistent at all locations, with maximum, minimum and average L_{Aeq} and L_{A90} values of the daytime and night-time periods typically falling within a 10 dB range;
- Noise sources at the survey locations were typically wildlife, livestock, people and motorbikes; and
- Diurnal variation was evident at all monitoring locations, to a varying degree. The ambient (L_{Aeq}) and background (L_{A90}) noise levels typically varied widely throughout the daytime period, becoming more consistent during the night-time period. Typically a peak was noted at sunset, followed by a gradual decrease in noise level throughout the night-time period, followed by a second peak at sunrise.

3.1.1 Kyakapere Village

Noise surveys were completed at four monitoring locations in this elongated settlement; NMP1, NMP2, NMP3 and NMP4. Of these, NMP2 and NMP4 were 24-hour measurements and NMP1 and NMP3 were spot measurements of 1 hour during the daytime and 1 hour during the night-time period.

The village comprises several clusters of traditional dwellings, built with mud walls and with thatched roofs. The settlement is bounded to the west by a steep escarpment and to the east by Lake Albert. The noise monitoring locations were sited approximately 100 m from the shore of Lake Albert. It is understood that fishing and livestock farming are the primary economic activities. Observations recorded during the survey indicate that audible noise at this community included noise from anthropogenic sources such as boats and motorcycles, as well as noise from children playing and from natural sources including livestock and wildlife.

The measured 10-minute averaged L_{Aeq} and L_{A90} levels recorded over the 24-hour monitoring periods at NMP2 are provided in Figure 5.

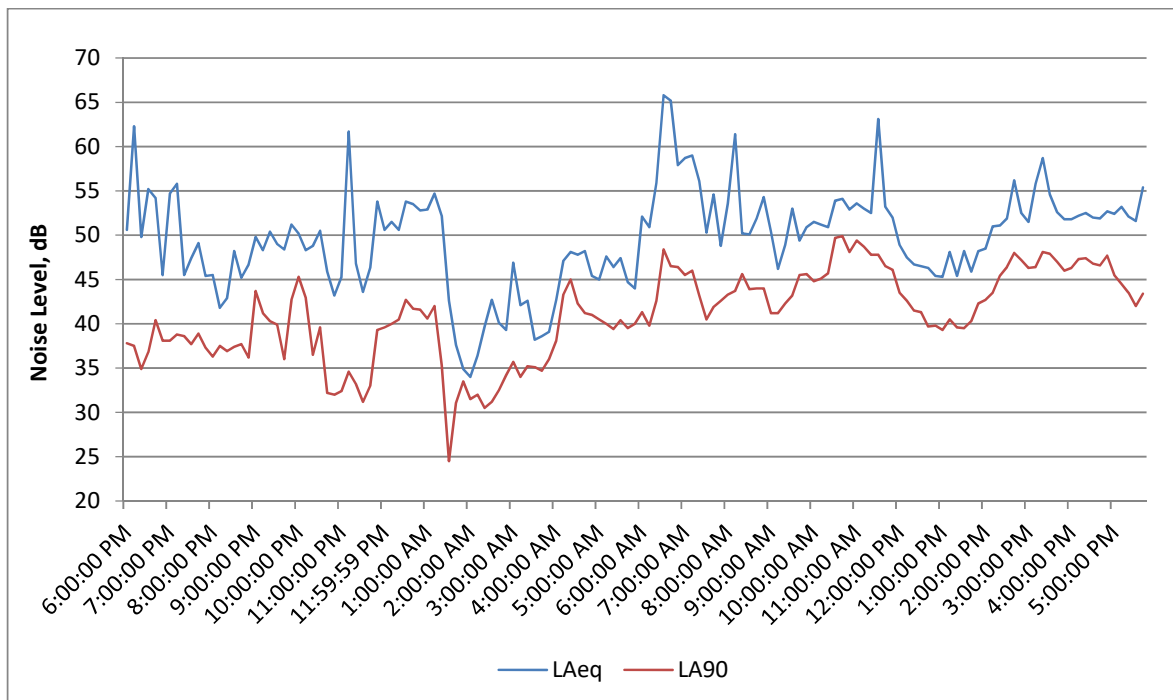

Figure 5: Measured $L_{Aeq,10min}$ and $L_{A90,10min}$ noise indices at NMP2

A summary of the measured noise levels is provided in Table 10.





Table 10: Measured noise levels at NMP2

	L _{Aeq,1hr}	L _{Aeq,10min}	L _{A90,1hr}	L _{A90,10min}
Daytime period (06:00 – 22:00)				
Max	61.5	65.8	47.9	49.9
Min	45.6	41.8	37.0	34.9
L _{A90,1hr} minimum exceeds Ugandan permissible level (50 dB)?			No	-
Night-time period (22:00 – 0600)				
Max	54.9	61.7	42.3	45.3
Min	39.5	34.0	32.2	24.5
L _{A90,1hr} minimum exceeds Ugandan permissible level (35 dB)?			No	-

A peak in the ambient noise level occurred at NMP2 at 06:30 and may relate to either an increase in human activity, such as of fishermen departing from, or returning to, land, or an increase in wildlife noise coinciding with sunrise.

NMP2 is shown in Figure 6.



Figure 6: Kyakapere village, monitoring location NMP2 near foot of escarpment

The measured 10-minute averaged L_{Aeq} and L_{A90} levels recorded over the 24-hour monitoring periods at NMP4 are provided in Figure 7.

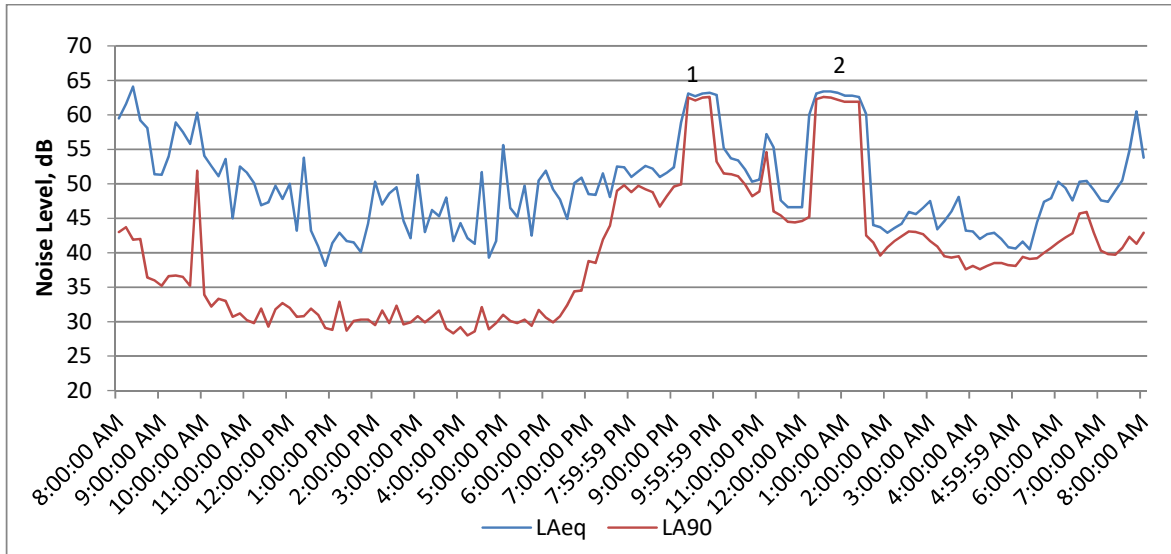

Figure 7: Measured $L_{Aeq,10min}$ and $L_{A90,10min}$ noise indices at NMP4

A summary of the measured noise levels is provided in Table 11.

Table 11: Measured noise levels at NMP4

	$L_{Aeq,1hr}$	$L_{Aeq,10min}$	$L_{A90,1hr}$	$L_{A90,10min}$
Daytime period (06:00 – 22:00)				
Max	61.8	64.1	60.8	62.6
Min	42.2	38.1	29.7	28.0
$L_{A90,1hr}$ minimum exceeds Ugandan permissible level (50 dB)?			No	-
Night-time period (22:00 – 0600)				
Max	62.0	63.4	60.7	62.6
Min	42.3	40.5	38.2	37.6
$L_{A90,1hr}$ minimum exceeds Ugandan permissible level (35 dB)?			Yes	-

At NMP4 two discrete peaks in the ambient and background levels of approximately 30 minutes and 1 hour duration (annotations 1 and 2 in Figure 3) were recorded during the night-time period. These episodes suggest a constant noise source, such as an engine or generator, operating at a fixed intensity and distance from the monitoring location. Field observations indicate that boats anchor near to this monitoring location, the engines or on-board generators of which have been attributed as the likely cause of these peaks.





NMP4 is shown in Figure 8.



Figure 8: Photograph of monitoring location NMP4 at Kyakapere Village with escarpment in distance

3.1.2 Kyabasambu Village

Kyabasambu village is smaller and more sparsely developed than Kyakapere, however, the construction of the dwellings and the primary activities are similar. Field notes indicate the dominant noise sources at the village to be wildlife, including frogs and ducks. Children and livestock (chickens) were also noted to be audible.

The measured 10-minute averaged ambient and background levels at NMP5 are provided in Figure 9.

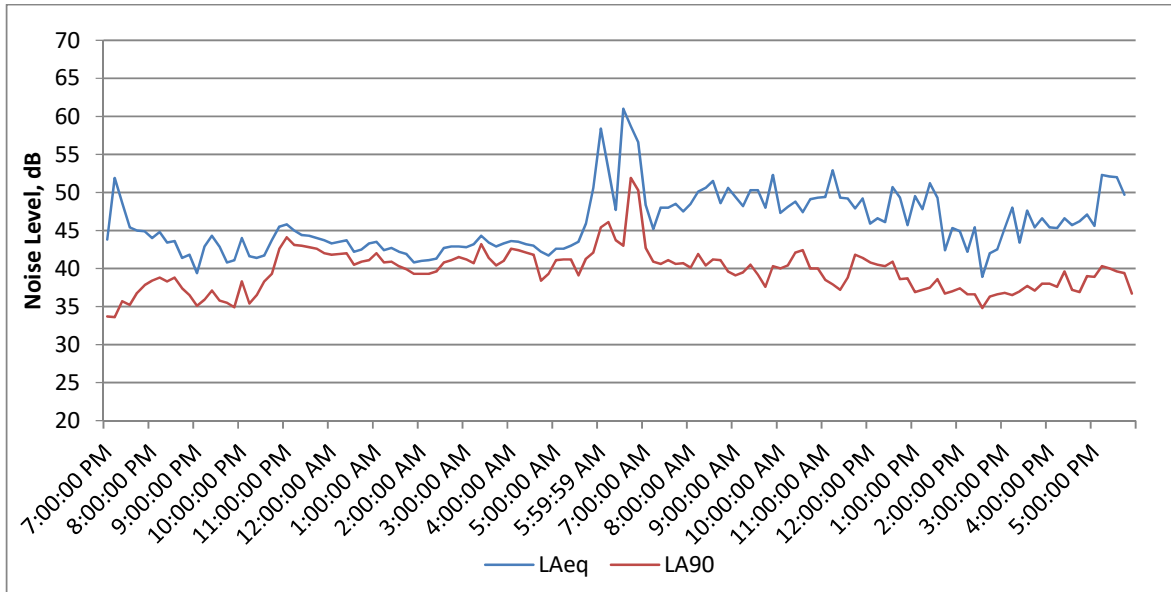

Figure 9: Measured $L_{Aeq,10min}$ and $L_{A90,10min}$ noise indices at NMP5

A summary of the measured noise levels is provided in Table 12.

Table 12: Measured noise levels at NMP5

	$L_{Aeq,1hr}$	$L_{Aeq,10min}$	$L_{A90,1hr}$	$L_{A90,10min}$
Daytime period (06:00 – 22:00)				
Max	57.5	61.0	48.0	51.9
Min	42.2	38.9	35.7	33.6
$L_{A90,1hr}$ minimum exceeds Ugandan permissible level (50 dB)?			No	-
Night-time period (22:00 – 0600)				
Max	45.9	50.6	43.0	44.1
Min	42.1	40.8	39.0	35.4
$L_{A90,1hr}$ minimum exceeds Ugandan permissible level (35 dB)?			Yes	-

Measured ambient and background noise levels varied little throughout the monitoring period, becoming particularly steady during the night-time period, with a range of 3.9 dB L_{A90} . This suggests a very constant noise source and is attributed to constant wildlife noise. Two peaks in the ambient and, to a lesser extent, background, noise levels occurred at 06:00 and 06:30. As with NMP2, this may represent an increase in human activity or animal noise at sunrise.

NMP5 is shown in Figure 10.





Figure 10: Kyabasambu Village

3.1.3 Kingfisher: Pad 1

Noise levels in the vicinity of the existing well pad were measured at NMP6. The pad is currently derelict and clear of structures and lies approximately 200 m from the nearest dwelling. The monitoring location is approximately 180 m from the edge of a lagoon and noted ecologically important area.

Anthropogenic noise sources in the area noted and included vehicles including trucks, cars and motorcycles. Noise from wildlife including birds, insects and amphibians was also audible. The measured 10-minute averaged ambient and background levels at NMP6 are provided in Figure 11.

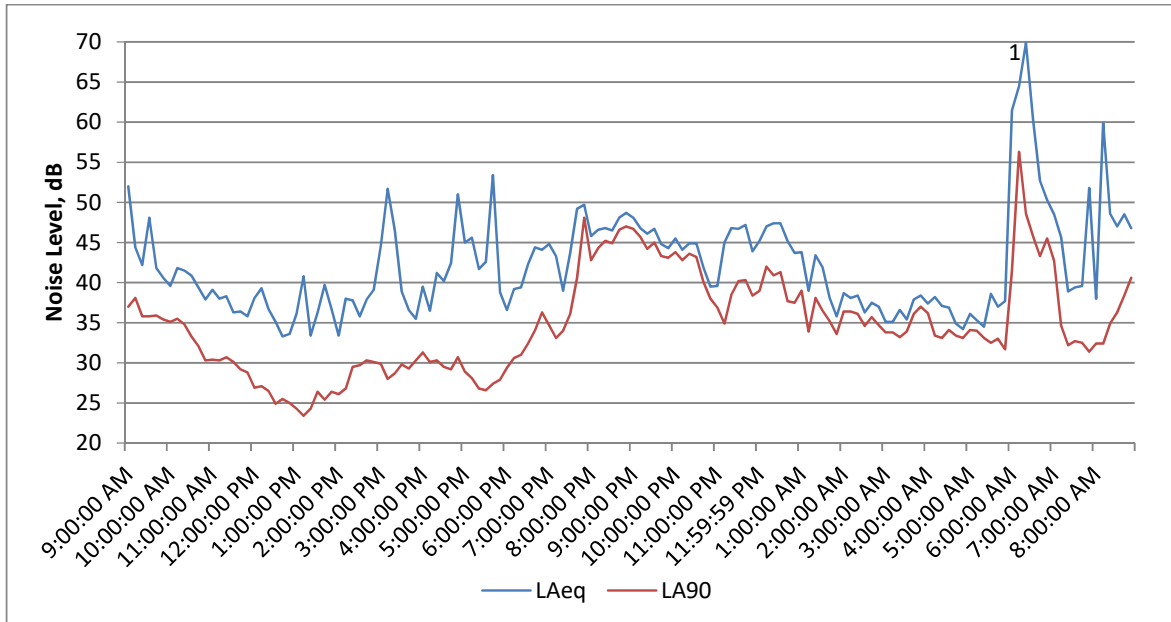

Figure 11: Measured $L_{Aeq,10min}$ and $LA_{90,10min}$ noise indices at NMP6

A summary of the measured noise levels is provided in Table 13.

Table 13: Measured noise levels at NMP6

	$L_{Aeq,1hr}$	$L_{Aeq,10min}$	$L_{A90,1hr}$	$L_{A90,10min}$
Daytime period (06:00 – 22:00)				
Max	64.1	69.9	50.1	56.3
Min	36.6	33.3	25.2	23.4
$L_{A90,1hr}$ minimum exceeds Ugandan permissible level (50 dB)?			No	-
Night-time period (22:00 – 0600)				
Max	46.2	47.4	42.4	43.8
Min	36.6	34.2	33.1	31.7
$L_{A90,1hr}$ minimum exceeds Ugandan permissible level (35 dB)?			No	-

A peak in measured noise levels occurred between 06:00 and 06:40 (annotation 1) which, as with other receptors, is attributed to an increase in human activity in the vicinity, or natural noise from either wildlife or meteorological conditions; a storm was noted in the area during the night-time monitoring.

NMP6 is shown in Figure 12.





Figure 12: Photograph of monitoring location NMP6 at Kingfisher 1 Pad

3.1.4 Nsonga (shore)

Nsonga lies on the plain between Lake Albert and the escarpment and is larger and more densely developed than Kyabasambu. Dwellings present in the village are constructed using traditional methods and materials. The currently-abandoned well pad 3 lies at the southern extent of the village.

The measured 10-minute averaged ambient and background levels at NMP7 are provided in Figure 13.

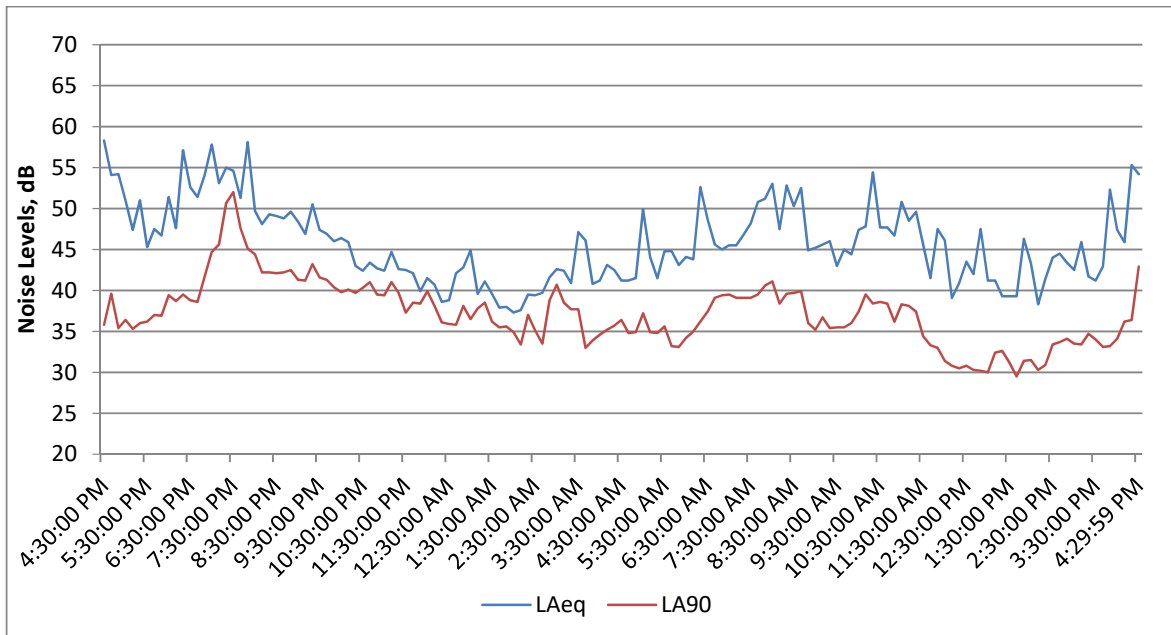

Figure 13: Measured $L_{Aeq,10min}$ and $L_{A90,10min}$ noise indices at NMP7

A summary of the measured noise levels is provided in Table 14.

Table 14: Measured noise levels at NMP7

	$L_{Aeq,1hr}$	$L_{Aeq,10min}$	$L_{A90,1hr}$	$L_{A90,10min}$
Daytime period (06:00 – 22:00)				
Max	55.6	58.3	48.6	52.0
Min	42.0	38.3	30.7	29.5
$L_{A90,1hr}$ minimum exceeds Ugandan permissible level (50 dB)?			No	-
Night-time period (22:00 – 0600)				
Max	45.6	49.9	40.1	41.0
Min	39.4	37.3	35.0	33.0
$L_{A90,1hr}$ minimum exceeds Ugandan permissible level (35 dB)?			No	-

Noise arising from human activities and also from livestock (cattle and goats) was noted to be dominant at this location. A peak in the background noise level occurred at 19:30, possibly due to an increase in wildlife noise at sunset.

The monitoring location is shown in Figure 14.





Figure 14: Photograph of monitoring location NMP7 at Nsonga

3.1.5 Nsunsu

Nsunsu is one of the smaller, lower density settlements in the area, predominantly located within 150 m of the lake shore. The ambient noise environment was noted to be dominated by livestock and human activity, including the use of motorcycles. The measured 10-minute averaged ambient and background levels at NMP8 are provided in Figure 15.

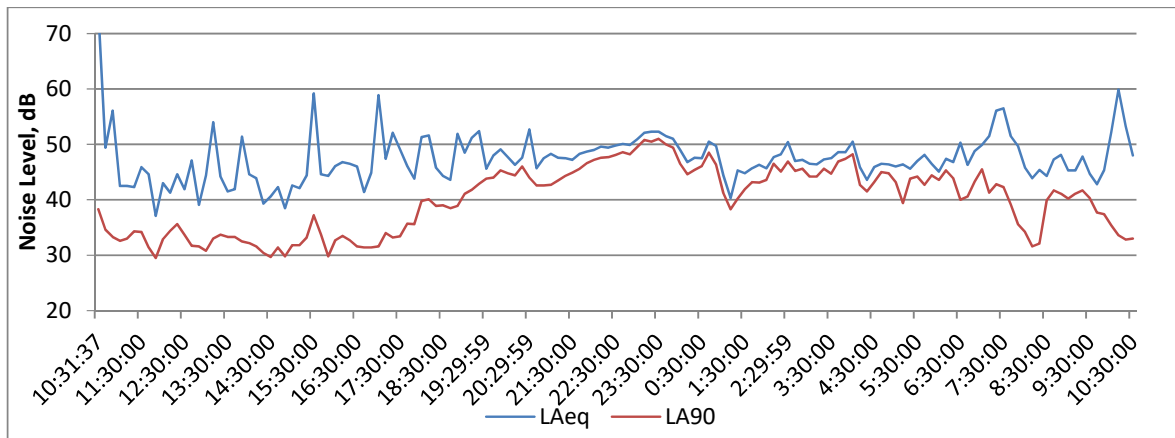



Figure 15: Measured $L_{Aeq,10min}$ and $LA_{90,10min}$ noise indices at NMP8

A summary of the measured noise levels is provided in Table 15.

Table 15: Measured noise levels at NMP8

	$L_{Aeq,1hr}$	$L_{Aeq,10min}$	$LA_{90,1hr}$	$LA_{90,10min}$
Daytime period (06:00 – 22:00)				
Max	53.4	74.5	44.8	46.6
Min	42.1	37.1	31.0	29.5
$LA_{90,1hr}$ minimum exceeds Ugandan permissible level (50 dB)?			No	-
Night-time period (22:00 – 0600)				
Max	51.7	52.3	50.2	51.0
Min	44.8	40.3	41.6	38.3
$LA_{90,1hr}$ minimum exceeds Ugandan permissible level (35 dB)?			Yes	-

The background noise level increases steadily from approximately 17:00 through until 23:30, after which it reaches a plateau and gradually decreases. The ambient and background values remain consistently close throughout the night-time period, diverging during the daytime. Such a pattern suggests a highly constant noise source being dominant during the night-time period. The constant noise level is attributed to noise from wildlife, such as insects and amphibians. Human activities or livestock are anticipated to be the cause of daytime variability.

The monitoring location is shown in Figure 16.





Figure 16: Photograph of monitoring location NMP8 at Nsunsu

3.1.6 Kiina Village

Kiina lies to the south of the Kingfisher Field area and there is little existing infrastructure nearby. The measured 10-minute averaged ambient and background levels at NMP9 are provided in Figure 17.

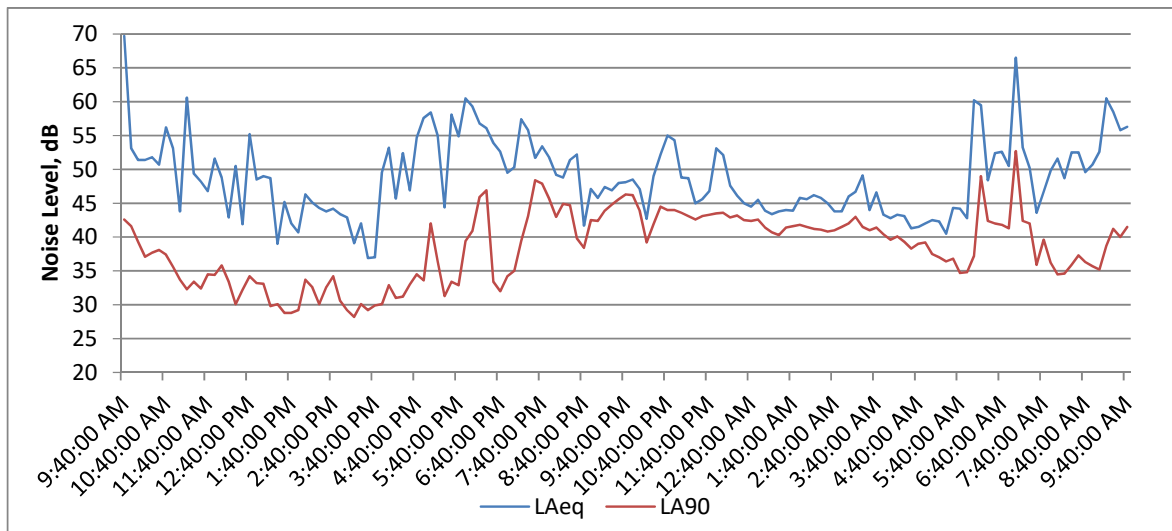



Figure 17: Measured $L_{Aeq,10min}$ and $L_{A90,10min}$ noise indices at NMP9

A summary of the measured noise levels is provided in Table 16.

Table 16: Measured noise levels at NMP9

	$L_{Aeq,1hr}$	$L_{Aeq,10min}$	$L_{A90,1hr}$	$L_{A90,10min}$
Daytime period (06:00 – 22:00)				
Max	59.2	69.7	46.0	52.7
Min	43.8	36.9	29.5	28.2
$L_{A90,1hr}$ minimum exceeds Ugandan permissible level (50 dB)?			No	-
Night-time period (22:00 – 0600)				
Max	51.8	55.0	43.2	44.5
Min	42.4	40.5	36.3	34.7
$L_{A90,1hr}$ minimum exceeds Ugandan permissible level (35 dB)?			Yes	-

Noise levels at Kiina Village varied in a broadly similar manner to those at other monitoring locations, with the background and ambient levels becoming consistent during the night-time and diverging during the day. Two peaks in the ambient noise level occurred at 06:00 and 07:00, possibly a result of human activity. Observations on the ambient noise environment at Kiina indicate livestock and human activity, including motorcycles, are dominant.

The monitoring location is shown in Figure 18.





Figure 18: Photograph of monitoring location NMP9 at Kiina Village

3.1.7 Ikamiro Village

Ikamiro Village lies approximately 3.5 km inland from the shore of Lake Albert and is surrounded by mature trees and forest, compared with the grassland and scrub found at the other receptors. The dominant noise sources at this location were, however, similar to those at other communities. People and livestock were noted to be the dominant contributors to ambient noise levels. The measured 10-minute averaged ambient and background levels at NMP9 are provided in Figure 19.

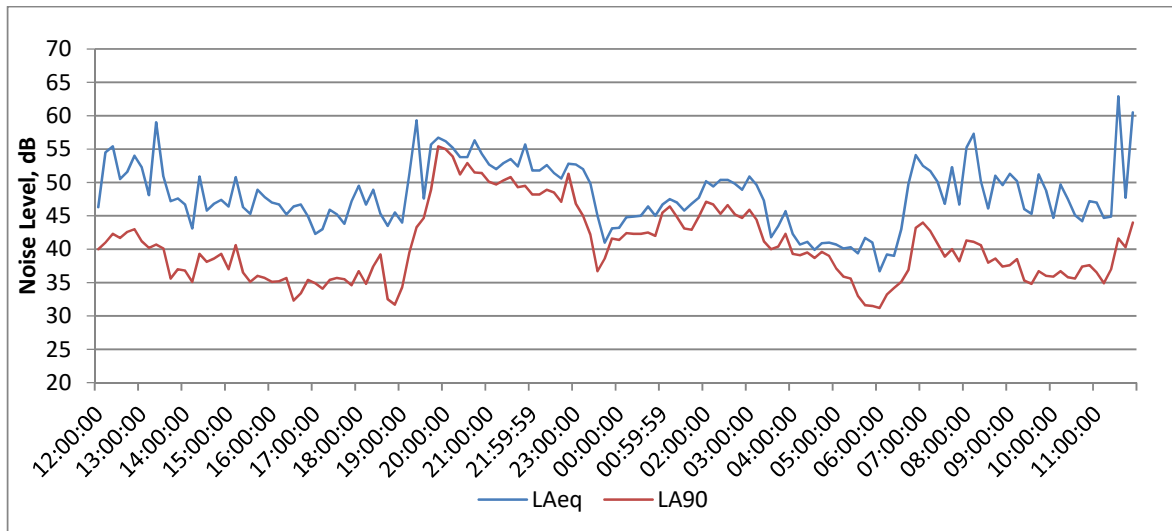

Figure 19: Measured $L_{Aeq,10min}$ and $L_{A90,10min}$ noise indices at NMP10

A summary of the measured noise levels is provided in Table 17.

Table 17: Measured noise levels at NMP10

	$L_{Aeq,1hr}$	$L_{Aeq,10min}$	$L_{A90,1hr}$	$L_{A90,10min}$
Daytime period (06:00 – 22:00)				
Max	57.3	62.9	52.9	55.4
Min	44.9	36.7	34.7	31.2
$L_{A90,1hr}$ minimum exceeds Ugandan permissible level (50 dB)?			No	-
Night-time period (22:00 – 0600)				
Max	51.9	52.8	48.9	51.3
Min	40.6	39.4	34.6	31.5
$L_{A90,1hr}$ minimum exceeds Ugandan permissible level (35 dB)?			No	-

Background and ambient noise levels at NMP10 are more consistent than at other monitoring locations in the study, with a smaller difference between the $L_{Aeq,10min}$ and $L_{A90,10min}$ during the daytime period. The pattern of variation was, however, similar; the background noise level at NMP10 reached a peak in the evening, followed by a gradual decrease throughout the night-time period. A second peak occurred which coincided with sunrise. Given the distance to the lake shore and consequent absence of fishing activity this increase is attributed to noise from wildlife and livestock. Wind-induced noise from the surrounding forest may also be a factor.

The monitoring location is shown in Figure 20.





Figure 20: Photograph of monitoring location NMP10 at Ikamiro Village

3.1.8 Mid-escarpment

Monitoring at location NMP11 was undertaken on the escarpment which bounds the plain of the shoreline of Lake Albert. Siting of the monitoring equipment was affected by the need to avoid wildfire hazards; hence the chosen location was approximately 160 m from the nearest dwelling. The measured 10-minute averaged ambient and background levels at NMP11 are provided in Figure 21.

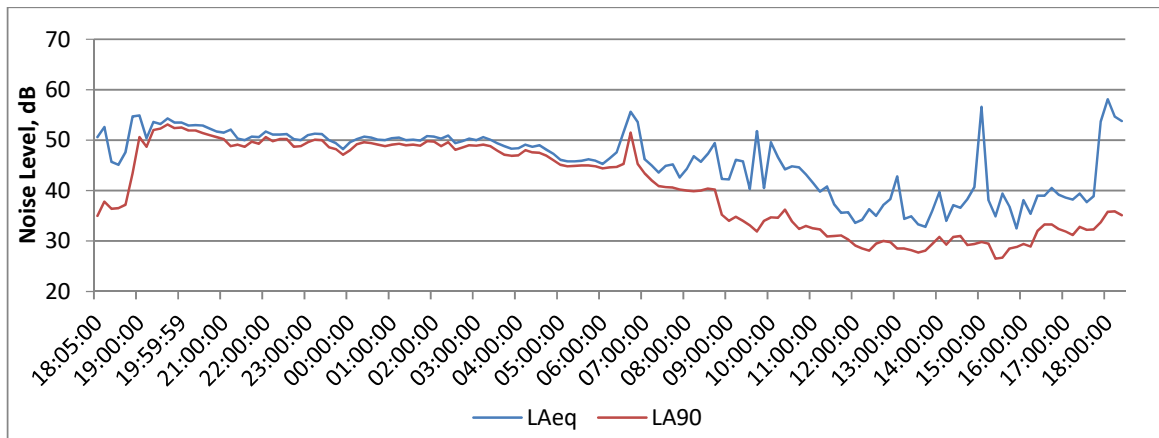



Figure 21: Measured LAeq,10min and LA90,10min noise indices at NMP11

A summary of the measured noise levels is provided in Table 18.

Table 18: Measured noise levels at NMP11

	LAeq,1hr	LAeq,10min	LA90,1hr	LA90,10min
Daytime period (06:00 – 22:00)				
Max	53.5	58.1	51.7	53.1
Min	36.1	32.5	28.4	26.5
LA90,1hr minimum exceeds Ugandan permissible level (50 dB)?			No	-
Night-time period (22:00 – 0600)				
Max	50.9	51.7	49.8	50.6
Min	46.0	45.8	44.9	44.8
LA90,1hr minimum exceeds Ugandan permissible level (35 dB)?			Yes	-

Monitoring notes indicated that the dominant noise sources at this location included cattle and wildlife, principally birds. The night-time ambient and background noise levels show a high degree of consistency, likely to be a result of wildlife noise.

Daytime ambient and background noise levels are typically lower than night-time noise levels at this monitoring location, this may be a result of the remoteness of this monitoring location from human habitation. Peaks in the daytime ambient noise level are likely to be a result of human activities.

The monitoring location is shown in Figure 22.





Figure 22: Photograph of monitoring location NMP11 on the escarpment

3.1.9 Foot of Escarpment

NMP12 was sited close to a watercourse at the foot of the escarpment, to the east of the Kingfisher Field. Close to this monitoring location people from the nearby villages quarry rocks on a small scale from the channel of the watercourse (River Nyakate). The measured 10-minute averaged ambient and background levels at NMP12 are provided in Figure 23.

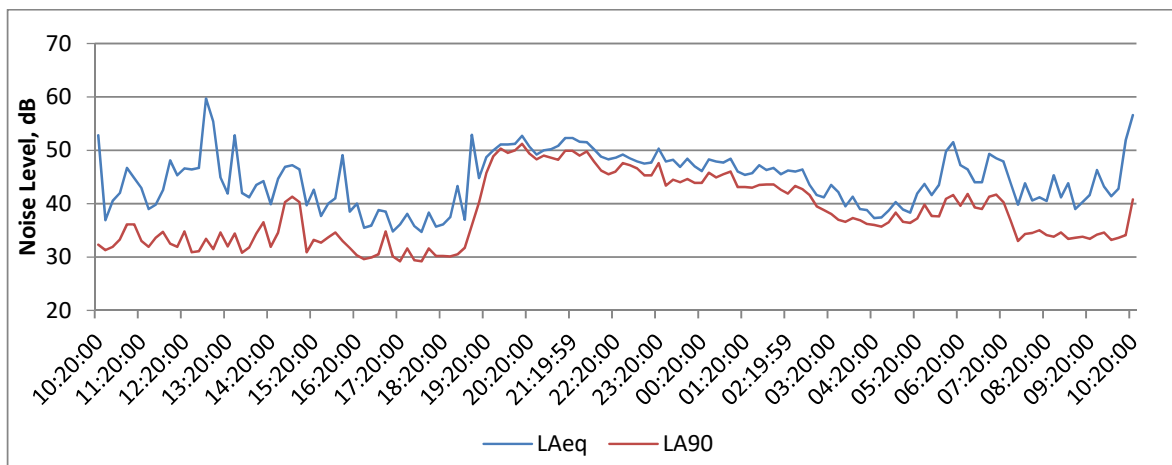



Figure 23: Measured $L_{Aeq,10min}$ and $L_{A90,10min}$ noise indices at NMP12

A summary of the measured noise levels is provided in Table 19.

Table 19: Measured noise levels at NMP12

	$L_{Aeq,1hr}$	$L_{Aeq,10min}$	$L_{A90,1hr}$	$L_{A90,10min}$
Daytime period (06:00 – 22:00)				
Max	52.9	59.7	49.5	51.2
Min	36.6	34.7	30.8	29.2
$L_{A90,1hr}$ minimum exceeds Ugandan permissible level (50 dB)?			No	-
Night-time period (22:00 – 0600)				
Max	48.6	50.3	46.6	47.6
Min	38.7	37.3	36.7	35.7
$L_{A90,1hr}$ minimum exceeds Ugandan permissible level (35 dB)?			Yes	-

Noise from the river and from quarrying activities was noted to be dominant during the daytime period, which is consistent with the steady background level recorded. The monitoring location is surrounded by bush, and the increase in background noise level around sunset is attributed to noise from wildlife such as insects and amphibians.

Peaks in the ambient noise level during the daytime are considered to represent human activity, including quarrying. The monitoring location is shown in Figure 24.





Figure 24: Photograph of monitoring location NMP12 at Nsonga

3.2 Summary of Baseline Noise Levels

A summary of the findings of the baseline noise survey is provided in Table 20.

Full results of the baseline survey are included in APPENDIX B.

Table 20: Average Measured Background Noise Levels by Receptor, dB LA90

Monitoring Location	Lowest Daytime Background dB LA90,1hr (06:00 – 22:00)	Lowest Night-time Background dB LA90,1hr (22:00 – 06:00)
NMP2 Kyakapere	37.0	32.2
NMP4 Kyakapere	29.7	38.2
NMP5 Kyabasambu	35.7	39.0
NMP6 Kingfisher 1 Pad	25.2	33.1
NMP7 Nsonga	30.7	35.0
NMP8 Nsunsu	31.0	41.6
NMP9 Kiina	29.5	36.3
NMP10 Ikamiro	34.7	34.6
NMP11 Mid-escarpment	28.4	44.9





Monitoring Location	Lowest Daytime Background dB LA90,1hr (06:00 – 22:00)	Lowest Night-time Background dB LA90,1hr (22:00 – 06:00)
NMP12 Foot of escarpment	30.8	36.7
Ugandan Regulations Permissible Noise Level, dB LAeq	50.0	35.0

Measured background noise levels at all receptors are highly spatially consistent across the study area, with daytime and night-time period-averaged levels typically falling within a 10 dB range, despite the differences in the micro-environments at which measurements were undertaken. Daytime and night-time period averaged noise levels vary little between the centres of villages to less developed, and more rural areas. Natural (non-anthropogenic) processes, and wildlife in particular, were found to be the dominant noise sources across the study area, with anthropogenic industrial noise from vehicles and machinery typically either absent or a minor contributor to the noise environment, except for defined short durations.

The 10-minute averaged background noise level varied greatly throughout the daytime period. The degree of diurnal variation in noise levels across the study area is attributed to the dominance of natural noise sources, with night-time noise levels higher than daytime levels at some monitoring locations. Natural environmental triggers, such as sunrise and sunset, result in observable increases in noise levels at most of the monitoring locations. Such noise sources may vary seasonally according to the life cycles of the organisms responsible, however, this assessment assumes that the levels measured are representative of “worst case” conditions. This assessment assumes that residents of the villages in the study area will be accustomed to the natural noise sources currently present, and that these natural noise sources will not typically result in sleep disturbance. As a result of revisions to the Project description since completion of the baseline noise survey, the results of the spot measurements taken at NMP1 and NMP3 are remote from project infrastructure, they are therefore not considered relevant to the assessment and results of the monitoring is not included in this report. The data is, however, provided in Appendix B.

The lowest average background noise levels for each village have been adopted as representative of the baseline noise environment and are provided in Table 21. The levels presented have been rounded to the nearest integer value. Where multiple monitoring locations were used for the same receptor (village) the lowest measured levels have been adopted.

Table 21: Adopted Background Noise Levels by Village, dB LA90

Location	Daytime, dB LA90,16hr (06:00 – 22:00)	Night-time, dB LA90,8hr (22:00 – 06:00)
Kyakapere Village – north	37	32
Kyakapere Village – south	30	38
Kyabasambu – north	36	39
Kyabasambu – south (KF1 pad)	25	33
Nsonga	31	35
Nsunsu	31	42
Kiina	30	36
Ikamiro	35	35





4.0 IMPACT ASSESSMENT

4.1 Construction Noise Impact

4.1.1 Construction Activities Assessed

The assessment of construction noise impact separately considers the impacts of the construction activities to build the processing complex (the CPF, well pads, flowlines access roads where not already built and other ancillary infrastructure on the Buhuka Flats, including the water intake station); and the impacts of drilling. Noise in the construction phase will last for 3 years, being limited to the period prior to first production at the CPF. Drilling continues beyond this date, but is then considered to be a joint operational impact, continuing for a further 5 years before all of the production and reinjection wells are completed. Decommissioning noise is considered to be similar to construction noise for the CPF complex.

The Rio Tinto evaluation criteria described in Section 2.3.1.3 above have been used as the basis for the evaluation of construction noise impact, with the Ugandan noise regulations providing the upper permissible limit.

4.1.2 Noise Predictions

Noise levels associated with decommissioning and abandonment stage have been assumed to be the same as those associated with construction, given the similarity between the work locations and the items of mobile plant which will be used.

The Kingfisher field comprises linear settlements, bounded by the shore of Lake Albert. The segmented and dispersed nature of the proposed Project infrastructure results in scenarios where settlements may be affected by noise sources on more than one side. Noise has been modelled for unmitigated and mitigated scenarios. Based on the modelling, the number of buildings within each 5 dBA impact zone has been defined and overlaid onto mapping showing village infrastructure. This provides an accurate representation of the number of buildings within each impact zone.

Where drilling and production occur simultaneously, noise levels at the closest receptors to the well pad where drilling is active are assumed to be 10 dB or more above those due to production alone at the same well pad. At these receptors, predicted levels from “drilling and production” will therefore be the same as those due to drilling only.

4.1.3 General Construction on the Buhuka Flats

4.1.3.1 Impacts

The noisiest stage of the construction works has been assumed to be clearance and construction works at the well pads, CPF and the laying of pipelines. Such works typically generate higher levels of noise than fabrication and finishing works, since greater numbers of heavy mobile plant are required. CNOOC have confirmed that no noisy construction works will be undertaken during the night-time period; this assessment therefore assumes that night-time activities will be restricted to use of hand tools and assembly activities, and no heavy plant will be used.

The construction sites will involve a multitude of activities, employing up to 1,173 personnel (including day workers) at peak times. Cranes, excavators, bulldozers, heavy vehicles, vibrating rollers, and a wide range of other mechanical and hand-operated equipment will be used. Most of the activity will be restricted within defined work areas, the principle of these being the CPF and permanent camp, as well as ancillary work areas which will include road construction sites (not already completed), the water intake station, the jetty (upgraded) and the airfield (upgraded), and the completion of 3 well pads (well pads 1, 2, and 3)⁶.

Noise during the construction phase has been modelled on the basis that works will take place at the CPF over the full construction period of three years, and at each well pad over a short period during the

⁶ Well pad 4A will be constructed during the operational phase, prior to the start of drilling in 2024





construction phase. A representative assemblage of plant, comprising two excavators, two road wagons, a dozer, a crane and a vibrating roller has been modelled at each worksite and noise levels predicted at the closest receptors to the worksite. Mobile plant items have been assumed to have an utilisation of 80 percent.

Figure 25⁷ presents an example of the effect of construction noise at well pad 3. Table 22 shows how many structures will be exposed to noise levels that exceed the upper permissible limits of the project standard. The increase in noise levels above the pre-existing background can be seen by comparing the data in the table with the measured sound levels shown for each village presented in Column 1 of the table.

⁷ Figure 25 shows a snapshot of construction while civil activities are taking place at well pad 3. The plots showing construction noise on the other well pads, combined with construction on the CPF, are presented in APPENDIX C.



NOISE IMPACT ASSESSMENT

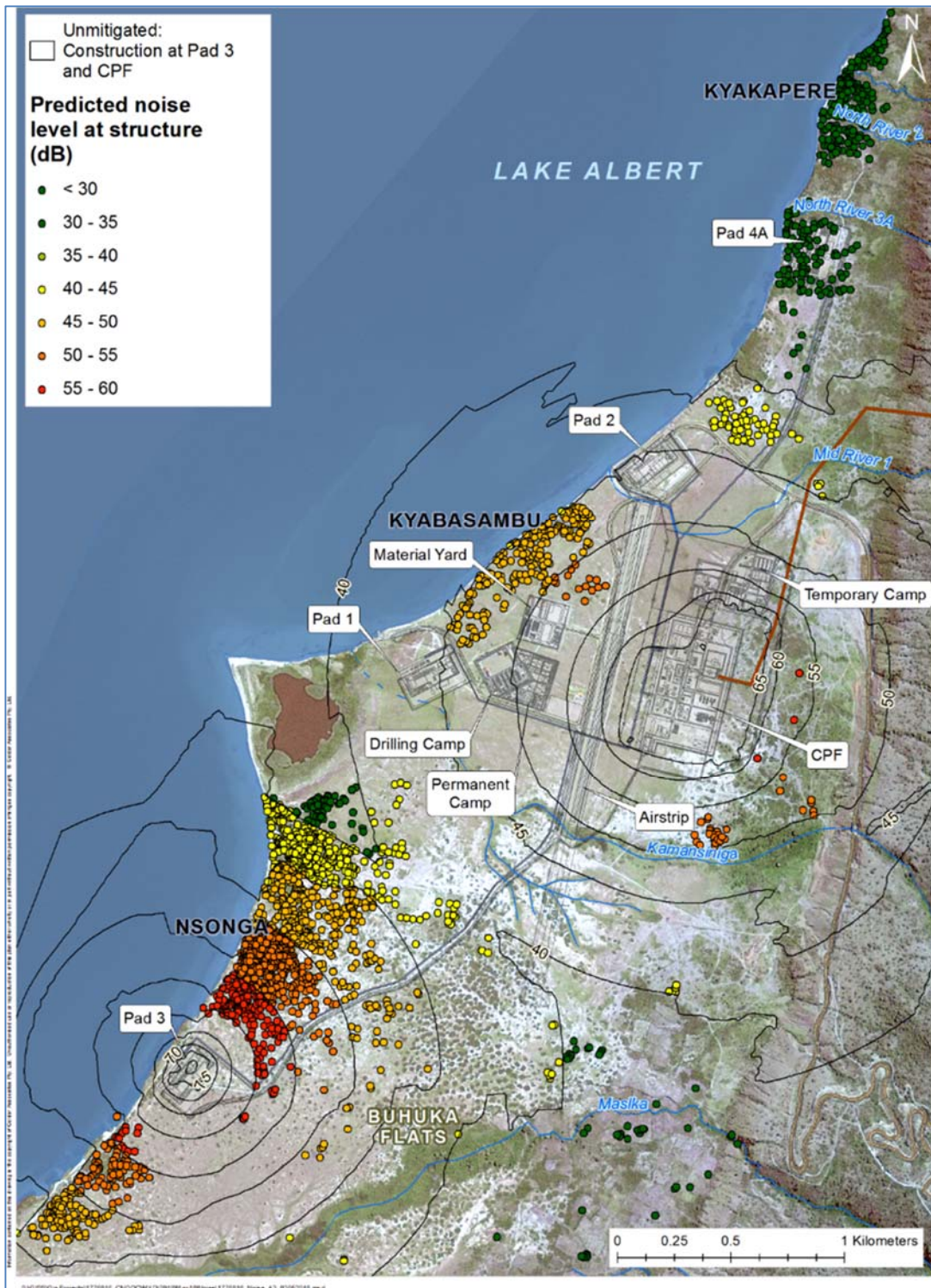

Figure 25: Example of unmitigated civil construction noise showing CPF construction and civil works ongoing simultaneously on Well Pad 3





Buildings are mainly residences, but since a family may occupy more than 1 building, or the buildings may only be seasonally occupied, reference in Table 22 is to buildings rather than households. A rough estimate is that, on average, each structure represents 4.5 people⁸.

Table 22: Household exposure to construction noise during the 3-year construction period and exceedance of daytime and night-time project standard - unmitigated case

Village (and adopted background noise levels)	Number of structures exposed to sound levels (dBA) (structures exposed to sound levels exceeding the daytime project standard are highlighted in blue)						Number of structures exposed to sound levels (dBA) (structures exposed to sound levels exceeding the night-time project standard are highlighted in brown)					
	30-35 dBA	35-40 dBA	40-45 dBA	45-50 dBA	50-55 dBA	55-60 dBA	30-35 dBA	35-40 dBA	40-45 dBA	45-50 dBA	50-55 dBA	55-60 dBA
CPF households			29	3	5				29	3	5	
Kyabasambu South <i>Daytime: 25 dBA</i> <i>Night-time: 33 dBA</i>			23	22	8				23	22	8	
Nsonga North <i>Daytime: 37 dBA</i> <i>Night-time: 32 dBA</i>	1	359	53	3			1	359	53	3		
Kyakapere South <i>Daytime: 30 dBA</i> <i>Night-time: 38 dBA</i>		9	27	30				9	27	30		
Kyabasambu North <i>Daytime: 37 dBA</i> <i>Night-time: 32 dBA</i>			58	50	10				58	50	10	
Nsonga South <i>Daytime: 31 dBA</i> <i>Night-time: 35 dBA</i>		153	330	153	55	9		153	330	153	55	9
Nsunzu North <i>Daytime: 31 dBA</i> <i>Night-time: 42 dBA</i>	7	96	67	12			7	96	67	12		
Kyakapere Village <i>Daytime: 37 dBA</i> <i>Night-time: 32 dBA</i>	86	16					86	16				
Nsonga East <i>Daytime: 31 dBA</i> <i>Night-time: 35 dBA</i>	20	25	1				20	25	1			

⁸ This is based on data for Kyakapere, which is assumed to be representative for other villages. LC 1 estimates indicate that the population of Kyakapere is 3,700 people. Satellite imagery indicates 824 structures. Therefore a rough relationship between structures (measurable from satellite imagery and population is that 1 structure represents 4.5 people.





Village (and adopted background noise levels)	Number of structures exposed to sound levels (dBA) (structures exposed to sound levels exceeding the daytime project standard are highlighted in blue)						Number of structures exposed to sound levels (dBA) (structures exposed to sound levels exceeding the night-time project standard are highlighted in brown)					
	30-35 dBA	35-40 dBA	40-45 dBA	45-50 dBA	50-55 dBA	55-60 dBA	30-35 dBA	35-40 dBA	40-45 dBA	45-50 dBA	50-55 dBA	55-60 dBA
Nsonga Daytime: 31 dBA Night-time: 35 dBA	2	94	10				2	94	10			
Kyabasambu East Daytime: 37 dBA Night-time: 32 dBA		19	5					19	5			

Note: (i) The boundaries of the villages may be seen from the Baseline section of the ESIA report. This table presents a consolidated assessment of construction at the CPF and well pads 1, 2 and 3. Well pad 4 is constructed during the operational phase of the project and is not included here. (ii) Baseline noise levels at Kyabasambu East were not measured and are assumed to be the same as Kyabasambu North (iii) Table 25 combines the impact of noise on people affected by construction on different well pads. This construction will not take place simultaneously.

The worst affected villages will be Nsonga and Kyabasambu. At night, the number of households affected by noise levels above the standard will be much higher, due to the more stringent threshold limit of 45 dBA. The unmitigated base case does not assume that construction activity will stop at night.

The impacts of greatest magnitude occur near the well pads when the platforms are under construction. This is simply due to their proximity to residents – the CPF construction generates similar or higher noise levels but is a greater distance from most settlement. Daytime noise levels will not exceed 60 dBA at any household (refer to Table 24). Forty one people (9 building structures at an average of 4.5 people per structure) are expected to reside within the 55-60 dBA **low** significance zone Table 23). For night-time noise, with its more stringent compliance requirement to avoid nuisance and sleep disturbance, 360 buildings (1621 people) would be affected by noise levels that exceed the target limit of 45 dBA. Impact significance will vary with distance from the well pad - Table 22 shows the numbers of people affected by varying degrees of daytime and night-time noise impact.

4.1.3.2 Mitigation

Careful vehicle and equipment selection in favour of low noise signatures, daytime construction noise impact can be reduced to **low** levels of significance. Regarding night time noise nuisance, the measures that are proposed, and which have been agreed to by CNOOC, will eliminate most night-time construction noise, and the significance of this impact will be **low**.





NOISE IMPACT ASSESSMENT

Table 23: Noise impacts during construction phase

Management Objectives: Noise levels due to the Project at noise sensitive receptors to be below the Ugandan maximum legal limit during daytime (75 dBL_{Aeq,1hr}) and night-time (65 dBL_{Aeq,1hr}) periods at all times and as far as possible below the target impact threshold levels of 55 dBA daytime and 45 dBA night-time.

Overall Significance before mitigation: Low (daytime), High (night-time)

Overall Significance after mitigation: Low (daytime), NSI (night-time)

Mitigation Measures	Monitoring Indicators	Monitoring Frequency	Responsible Entity	Training Necessary
Construction plant silenced with enhanced exhaust mufflers and engine compartment sound insulation.	Daytime noise target of 55 dBL _{Aeq,1hr} not exceeded at neighbouring receptors. Maximum legally permissible noise is 75 dBA	Monthly	CNOOC and Contractors	Use of sound level meters and monitoring techniques and procedures
Construction works involving heavy plant restricted to daytime period only. Only hand tools will be used during any night-time working.	No construction works before 06:00 or after 22:00	N/A	CNOOC and Contractors	N/A



4.1.4 Drilling of Wells

4.1.4.1 Impacts

The drilling rig is the single most significant construction phase noise source associated with the project. Drilling noise is generated on the platform and by the motor on top of the mast, at an elevation of around 40 m above the ground. Drilling is a 24/7 activity, and while there will be only one drilling rig on site, which moves from well pad to well pad, the drilling of multiple oil and reinjection wells on the same well pad will mean that the noise in one location will continue over an extended period. In sequence, the drilling during the construction phase is expected to be as follows:

- Well Pad 2 (240 days);
- Well Pad 3 (255 days); and
- Well Pad 1 (210 days).

These periods of noise exposure are far beyond what would be regarded as transient in the Rio Tinto rating scale, being considered to be long term (>6 months).

Table 24 shows the significance of the noise impact in the villages affected by combined CPF construction and unmitigated drilling noise in relation to the number of building structures affected⁹. Figure 26 is a plot of noise levels caused by CPF construction and drilling on well pad 3 at the same time. Other plots showing the combination of CPF construction noise and drilling noise on well pads 1 and 2 are included in Specialist Study 6.

Many households are above the project's target threshold for daytime (blue shading) and night-time (brown shading) construction noise. Most people will also experience a very large increase in noise levels, in some cases exceeding 30 dBA above the natural background noise levels. Assuming a relationship of roughly 4.5 people per building, approximately 972 and 6,485 villagers will be exposed to daytime and night time noise levels respectively that exceed the project's target thresholds. Table 24 shows that in the daytime, most people are impacted by sound levels within 5 dBA of the 55 dBA target threshold. During the night-time, with the more stringent requirements for quiet, larger numbers of people will experience higher levels of noise, with around 15% of the affected people being more than 10 dBA above the 45 dBA target. Broken down, the night-time impact significance in the unmitigated case will be as follows (refer to Table 24):

- **High** significance (>55 dBA): 972 people (216 building structures);
- **Medium** significance (50-55 dBA): 2,556 people (568 building structures); and
- **Low** significance (45-50 dBA): 2,957 people (657 building structures).

One building in Nsonga south exceeds the legal night-time standard.

⁹ Plots of drilling noise impacts on other well pads are included in the Specialist Report on Noise



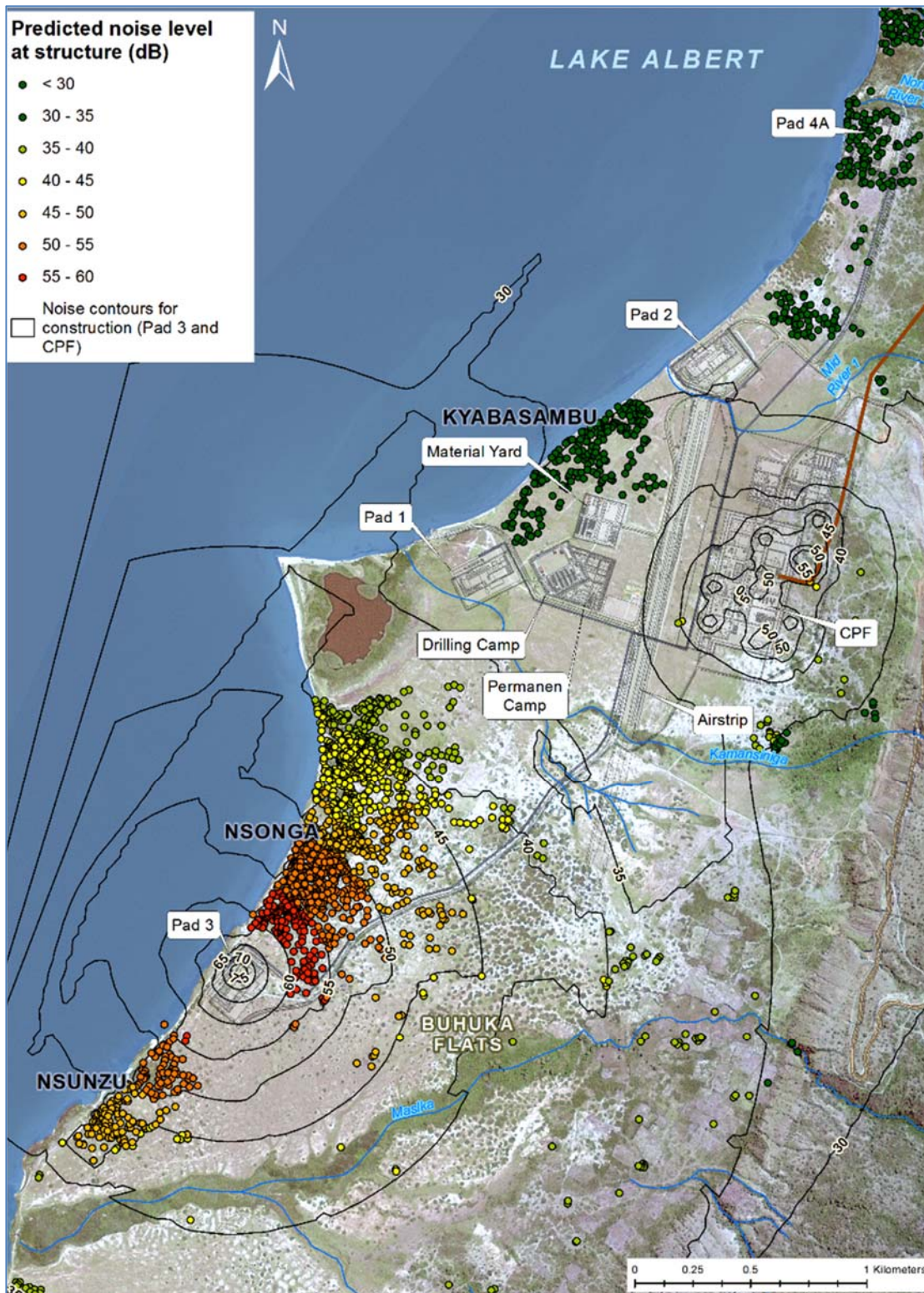

Figure 26: Example of unmitigated drilling noise including CPF construction and drilling on Well Pad 3





Table 24: Household exposure to CPF drilling noise during the 3-year construction period and exceedance of the daytime and night-time project standard – unmitigated case

Village (and adopted background noise levels)	Number of structures exposed to sound levels (dBA) (structures exposed to sound levels exceeding the daytime project standard are highlighted in blue)								Number of structures exposed to sound levels (dBA) (structures exposed to sound levels exceeding the night time project standard are highlighted in brown)							
	30-35 dBA	35-40 dBA	40-45 dBA	45-50 dBA	50-55 dBA	55-60 dBA	60-65 dBA	65-70 dBA	30-35 dBA	35-40 dBA	40-45 dBA	45-50 dBA	50-55 dBA	55-60 dBA	60-65 dBA	65-70 dBA
CPF Households																
Kyabasambu South <i>Daytime: 25 dBA</i> <i>Night-time: 33 dBA</i>					19	22	12						19	22	12	
Nsonga North <i>Daytime: 37 dBA</i> <i>Night-time: 32 dBA</i>			153	257	6						153	257	6			
Kyakapere South <i>Daytime: 30 dBA</i> <i>Night-time: 38 dBA</i>			3	17	46						3	17	46			
Kyabasambu North <i>Daytime: 37 dBA</i> <i>Night-time: 32 dBA</i>				23	75	20						23	75	20		
Nsonga South <i>Daytime: 31 dBA</i> <i>Night-time: 35 dBA</i>			32	164	344	129	30	1			32	164	344	129	30	1
Nsunzu North <i>Daytime: 31 dBA</i> <i>Night-time: 42 dBA</i>		2	15	99	64	2				2	15	99	64	2		
Kyakapere Village <i>Daytime: 37 dBA</i> <i>Night-time: 32 dBA</i>	127	90	101						127	90	101					
Nsonga East <i>Daytime: 31 dBA</i> <i>Night-time: 35 dBA</i>	4	53	10	19					4	53	10	19				
Nsonga <i>Daytime: 31 dBA</i> <i>Night-time: 35 dBA</i>		1	37	68						1	37	68				
Kyabasambu East <i>Daytime: 37 dBA</i> <i>Night-time: 32 dBA</i>				10	14							10	14			

Note: The boundaries of the villages may be seen from the Baseline section of the report. This table presents a consolidated assessment of construction at the CPF and well pads 1, 2 and 3. Well pad 4 is constructed during the operational phase and is not included here





4.1.4.2 Mitigation

The following mitigation of drilling noise is proposed:

- Erect acoustic barriers (noise ‘curtains’) around the drilling rig, screening to above the drilling platform, and 5m high screens above ground level around the perimeter of the site and/or acoustic enclosures around the engine, mud pumps and blower fan; and
- Separate the top drive and the blower fans and install the fans at ground level.

Estimates based on data provided by vendor estimates show that up to 10 dBA of source attenuation could be achieved. Screens could be made from a variety of materials of which the most practical may be stacked shipping containers. Table 25 shows the change in affected building structures that will result from the decrease in noise. During the daytime, impact significance will be **low**, with only 1 building structure (roughly 5 people) affected by noise exceeding the 55 dBA target. At night, 973 people (216 buildings) will be affected by noise above the 45 dBA target. Of these, most (60%) will reside in Nsonga South, which is affected primarily by the drilling of wells on well pad 3. The significance of residual impact for night-time noise will be as follows (refer to Table 25):

- **High** significance (>55 dBA): 5 people (1 building structure);
- **Medium** significance (50-55 dBA): 189 people (42 building structures); and
- **Low** significance (45-50 dBA): 779 people (173 building structures).

Table 25: Household exposure to drilling noise at well pads 1, 2, 3 over a 3-year period and exceedance of the daytime and night-time project standard (the plots show combined noise with construction of the CPF) - mitigated case

Village (and adopted background noise levels)	Number of structures exposed to sound levels (dBA) (structures exposed to sound levels exceeding the daytime project standard are highlighted in blue)								Number of structures exposed to sound levels (dBA) (structures exposed to sound levels exceeding the night time project standard are highlighted in brown)							
	20-25 dBA	25-30 dBA	30-35 dBA	35-40 dBA	40-45 dBA	45-50 dBA	50-55 dBA	55-60 dBA	20-25 dBA	25-30 dBA	30-35 dBA	35-40 dBA	40-45 dBA	45-50 dBA	50-55 dBA	55-60 dBA
CPF households			30	4	1						30	4	1			
Kyabasambu South <i>Daytime: 25 dBA Night-time: 33 dBA</i>					19	22	12						19	22	12	
Nsonga North <i>Daytime: 37 dBA Night-time: 32 dBA</i>			153	257	6						153	257	6			
Kyakapere South <i>Daytime: 30 dBA Night-time: 38 dBA</i>			3	17	46						3	17	46			
Kyabasambu North <i>Daytime: 37 dBA Night-time: 32 dBA</i>				23	75	20						23	75	20		





NOISE IMPACT ASSESSMENT

Village (and adopted background noise levels)	Number of structures exposed to sound levels (dBA) (structures exposed to sound levels exceeding the daytime project standard are highlighted in blue)								Number of structures exposed to sound levels (dBA) (structures exposed to sound levels exceeding the night time project standard are highlighted in brown)							
	20-25 dBA	25-30 dBA	30-35 dBA	35-40 dBA	40-45 dBA	45-50 dBA	50-55 dBA	55-60 dBA	20-25 dBA	25-30 dBA	30-35 dBA	35-40 dBA	40-45 dBA	45-50 dBA	50-55 dBA	55-60 dBA
Nsonga South <i>Daytime: 31 dBA</i> <i>Night-time: 35 dBA</i>			32	164	344	129	30	1			32	164	344	129	30	1
Nsunzu North <i>Daytime: 31 dBA</i> <i>Night-time: 42 dBA</i>		2	15	99	64	2				2	15	99	64	2		
Kyakapere Village <i>Daytime: 37 dBA</i> <i>Night-time: 32 dBA</i>	127	90	101						127	90	101					
Nsonga East <i>Daytime: 31 dBA</i> <i>Night-time: 35 dBA</i>	4	53	10	19					4	53	10	19				
Nsonga <i>Daytime: 31 dBA</i> <i>Night-time: 35 dBA</i>		1	37	68						1	37	68				
Kyabasambu East <i>Daytime: 37 dBA</i> <i>Night-time: 32 dBA</i>				10	14							10	14			

Note: The boundaries of the villages may be seen from the Baseline section of the report. This table presents a consolidated assessment of construction at the CPF and well pads 1, 2 and 3. Well pad 4 is constructed during the operational phase and is not included here

While the temporary nature of the noise permits higher acceptable noise levels, people around the drilling rigs will be exposed to residual noise (particularly at night) which is far above the existing ambient. Additional mitigation should be considered for the approximately 972 people who will be exposed to noise exceeding the night-time target threshold. This may include temporary housing for the period in which the drilling rig is located in the area.



NOISE IMPACT ASSESSMENT

Table 26: Noise impacts during drilling phase

Management Objectives: Noise levels due to the Project at noise sensitive receptors to be below the Ugandan maximum legal limit during daytime (75 dBL_{Aeq,1hr}) and night-time (65 dBL_{Aeq,1hr}) periods at all times and as far as possible below the target impact threshold levels of 55 dBA daytime and 45 dBA night-time.

Overall Significance before mitigation: Mainly Medium (daytime), Major (night-time)

Overall Significance after (source and barrier) mitigation: Mainly Low (daytime), Medium (night-time)

Mitigation Measures	Monitoring Indicators	Monitoring Frequency	Responsible Entity	Training Necessary
<p>Erection of acoustic barriers (noise 'curtains') around the drilling rig screening to above the drilling platform. Separation of the top drive and the blower fans and installation of the fans at ground level.</p> <p>Erection of acoustic barriers (shipping containers or similar) around the well pad to create 5m high screens and/or acoustic enclosures around the engine, mud pumps and blower fan. The enclosures should be constructed of resilient material, lined with an acoustically absorptive material and appropriately vented and fire-proofed.</p> <p>Screens must completely exclude line of sight to the noise source from the nearest receptor, with no gaps or holes, and be constructed from material of a high surface area density (>15 kg/m²).</p> <p>The acoustic attenuation surrounding the drill site has been assumed to provide a 10 dB overall reduction in noise.</p> <p>To manage residual impacts, consider temporary relocation of residents affected by noise levels exceeding 50 dBA.</p>	<p>Reduction of noise from elevated noise sources by 10 dB(A) or more.</p> <p>Containment of ground level sources using containers or similar solid barriers between sources and residents.</p> <p>Daytime drilling phase noise target of 55 dBL_{Aeq,1hr} and night-time noise target of 45 dBL_{Aeq,1hr} not exceeded at neighbouring receptors.</p> <p>Maximum legally permissible noise is 75 dBA daytime and 65 dBA daytime</p>	Monthly	CNOOC and Contractors	Use of sound level meters and monitoring techniques and procedures





4.1.5 Construction of Feeder pipeline

4.1.5.1 Impacts

No construction will take place at night along the feeder pipeline and noise impacts along the pipeline right of way will therefore not be subject to the more stringent night-time standards described in the relevant guidelines. Assessment of impact is in accordance with the standard in Table 4, described in Section 2.4.1.

Table 26 shows the significance of daytime construction noise impact along the feeder pipeline, based on distance from the construction right of way. A total of 11 buildings (roughly 50 people) will be affected by noise levels that are greater than an L_{Aeq} (1 hr) of 65 dBA. These impacts will be well below the Ugandan legal limit for construction activities of 75 dBA and will be of **low** significance. While the noise generated by vehicles bringing materials along the pipeline right of way may extend for periods of up to six months, the noise generated by construction teams working on the welding and laying of the pipeline would, in most cases, be considerably shorter than this, and would progress quickly past any household, extending the distance of the main noise sources from any receiver daily.

Table 26: Significance of construction phase noise impact with distance from the pipeline for the daytime period (showing number of affected buildings)

Receptor distance from noise source*	Number of Affected Buildings**		
	Predicted sound levels >65 dBA (dB $L_{Aeq,1hr}$) Significance Low	Predicted sound levels 60-65 dBA (dB $L_{Aeq,1hr}$) Significance Negligible (NSI)	Predicted sound levels 55 -60 dBA (dB $L_{Aeq,1hr}$) Significance Negligible (NSI)
0 - 10m from pipeline RoW	11	0	0
10 m - 50m from pipeline RoW	0	5	0
50 m – 100 m from pipeline RoW	0	-	4
100m - 200m from pipeline RoW	0	0	0

RoW = Right of Way

* Distances are from the edge of the construction right of way

** The relationship between building structures and number of people affected is uncertain but is probably in the order of 1 building = 4.5 people.

4.1.5.2 Mitigation

By tolerating a higher level of noise in surrounding communities due to the short term nature of the construction activities, the target thresholds permit a large increase above the background ambient sound levels that are typical of rural areas. Noise levels will be potentially disturbing for short periods of time for people living close to the construction right of way and along the main access roads. All reasonable, practical, means of limiting pipeline construction noise effects should be implemented. This is particularly important if any areas where sensitive land uses such as schools, churches or clinics are affected.

The following mitigation and monitoring is recommended:

- Comply with the daytime construction restrictions. Daytime should be defined as daylight hours from 06:00 - 18:00;
- Train all drivers and equipment operators to minimise unnecessary generation of noise;
- Train all personnel to be aware of noise nuisance and to minimise their noise footprint in the surrounding community;





- Flag any schools, clinics or places of worship within 100m - 200 m of the construction RoW and monitor noise at these locations. If necessary, take measures to minimise the effect of the noisiest activities by timing them to avoid critical periods in the school/worship calendar;
- Ensure that silencers on all vehicles and equipment are properly maintained;
- Communicate with the families in proximity to the right of way to ensure that there is an understanding of the temporary nature of the noise and the expected schedules for construction;
- Use the pipeline construction as an educational opportunity for school children in the communities along the pipeline;
- In areas where blasting is necessary, advise surrounding communities well in advance of the blast schedules. If any blasting is required within 200 m of households, undertake photograph surveys of the buildings before and after blasting and measure blast shock; and
- Shield the camp generator with acoustic screening. This should provide the necessary acoustic insulation to minimise night-time noise to levels of low significance.

These measures will assist in minimising the more annoying and unnecessary aspects of construction noise along the feeder line RoW.

4.1.6 Production (Operational) Phase

4.1.6.1 *Impacts*

Noise generated at the CPF during the operational phase will include the operation of gas engines and other plant. Details of noise emission sources are provided in Section 2.5.3.4. No households will exceed the maximum recommended daytime or night-time limit of 55 dBA and 45 dBA respectively, due to noise caused by the production facility (Figure 27). Noise levels in Figure 27 include the embedded mitigation indicated by CNOOC, described in Section 2.5.3.4. Three buildings (households) will be relocated/ compensated for since they are within the footprint of the CPF. Two buildings that are close to the eastern and south-eastern boundaries of the CPF will experience noise levels that are potentially up to 3 dBA above the existing baseline. For these households, impacts will be local, definite, of low magnitude and long duration, resulting in a rating of **low medium** impact significance. For all other households, impact magnitude will be negligible and impact significance will be **low**.



NOISE IMPACT ASSESSMENT

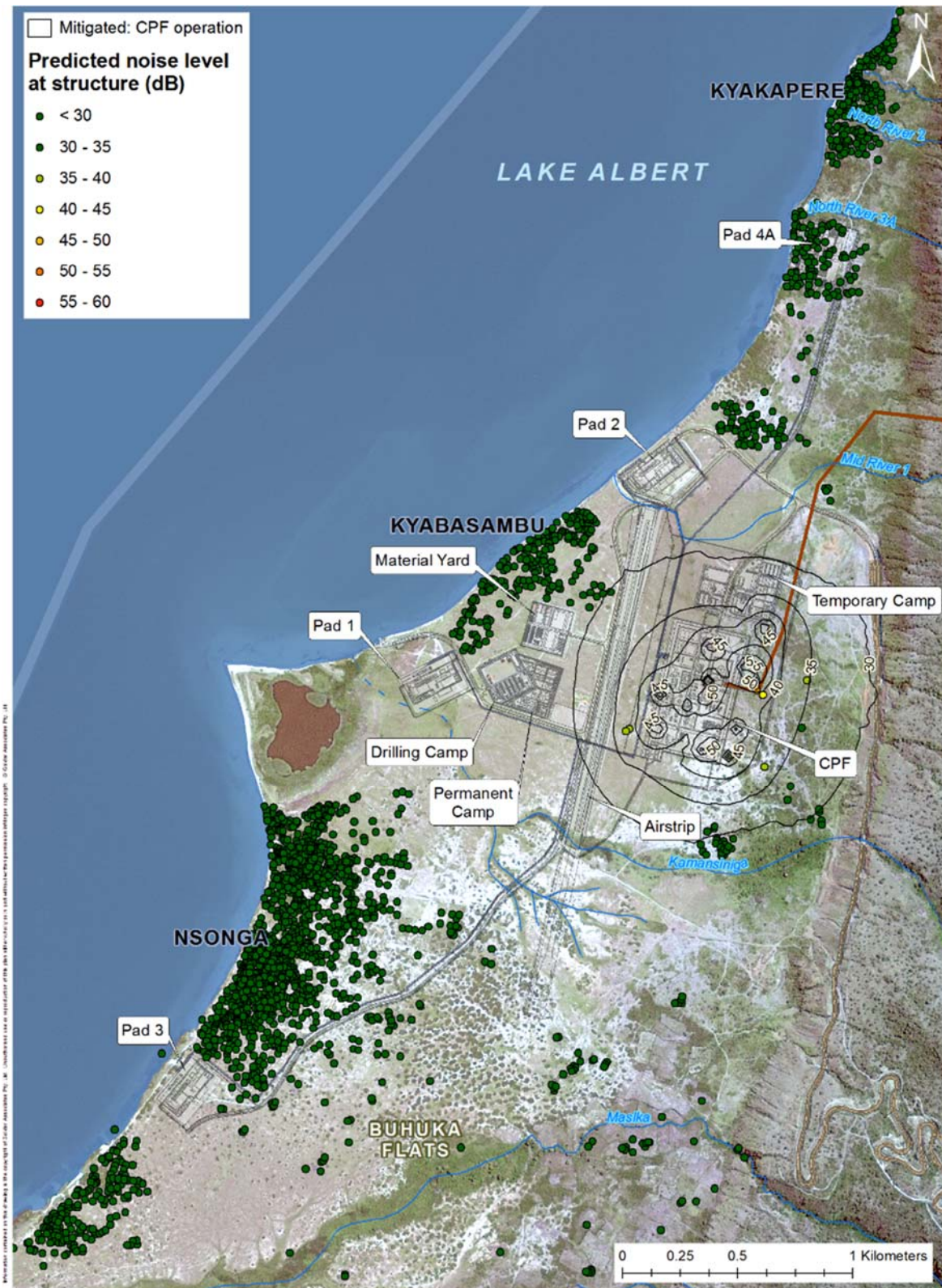

Figure 27: Noise Levels caused by Production at the CPF (including embedded mitigation indicated in Section 2.5.3.4)





4.1.6.2 *Mitigation*

Noise during production, when all of the well pads are assumed to be running semi-autonomously, with no mobile noise sources, may be effectively controlled by installation of screens and acoustic enclosures. At the well pads, noise from items of fixed plant will be limited to a maximum of 3 dB above the background level measured at the closest baseline monitoring point when measured at the well pad boundary.

At the CPF, the embedded noise controls proposed by CNOOC, which may include sourcing of quieter equipment, acoustic enclosures and other attenuation measures to reduce sound power levels of each source to a maximum of 75 dB(A), will reduce noise levels to low levels of significance in all but 2 cases, where predicted noise levels will exceed 35 dBA. These households are situated within a proposed buffer zone, proposed by Golder for the management of environmental and social impact as a whole, and where settlement should not be permitted. Subject to resettlement of the affected families outside of this zone, all operational noise impact will be of **low** significance.



NOISE IMPACT ASSESSMENT

Table 27: Noise impacts during production phase

Management Objectives: Noise levels due to the Project at noise sensitive receptors below the Ugandan permissible noise levels during daytime (55 dBL_{Aeq,1hr}) and night-time (45 dBL_{Aeq,1hr}) periods

Overall Significance before mitigation: Low (daytime), Low (night-time) except 2 households east of CPF (Low Medium)

Overall Significance after mitigation: Low (daytime), Low (night-time)

Mitigation Measures	Monitoring Indicators	Monitoring Frequency	Responsible Entity	Training Necessary
<p>Specification of acoustic enclosures and noise attenuation measures at CPF to fixed plant to reduce sound power level of each item to a maximum of 75 dB(A) or as required in order to meet daytime and night-time permissible noise levels at neighbouring receptors.</p> <p>Households within the 35 dBA noise contour (east of the CPF) to be relocated.</p> <p>At well pads the noise level at the boundary of the pad will not exceed the measured baseline level at that location by more than 3 dB. Attenuation to be fitted to plant if this boundary limit is exceeded.</p>	<p>Daytime operations phase noise limit of 55 dBL_{Aeq,1hr} and night-time operations phase noise limit of 45 dBL_{Aeq,1hr} not exceeded at neighbouring receptors.</p> <p>Increase should not exceed existing baseline by >3 dBA</p>	<p>Subsequent to installation and switch-on and annually thereafter</p>	<p>CNOOC and Contractors</p>	<p>Use of sound level meters and monitoring techniques and procedures</p>



4.1.7 Impact Rating

4.1.7.1 Construction Phase (civil construction excluding drilling impacts)

Impacts are rated in Table 28 in accordance with the methodology described in Section 2.4.1.

Table 28: Construction phase impacts of noise (civil works of CPF complex and associated infrastructure)

Indicator of potential impact	Pre-mitigation					Post-mitigation				
	Magnitude	Duration	Geographic Extent	Probability	Significance	Magnitude	Duration	Geographic Extent	Probability	Significance
Daytime Impact of Civil Construction Noise (9 buildings – 55-60 dBA)	-	-	-	-	Low	-	-	-	-	Low
Night time Impact of Civil Construction Noise (9 buildings - 55-60 dBA)	-	-	-	-	High	No work at night				NSI
Night time Impact of Civil Construction Noise (78 buildings - 50-55 dBA)	-	-	-	-	Medium	No work at night				NSI
Night time Impact of Civil Construction Noise (273 buildings- 45-50 dBA)	-	-	-	-	Low	No work at night				NSI

KEY (Note: The standard ESIA rating scale does not apply to construction noise – refer to the methodology above)

Magnitude	Duration	Scale	Probability
10 Very high/ don't know	4 Permanent	5 International	5 Definite/don't know
8 High	3 Long-term (>6 months)	4 National	4 Highly probable
6 Medium	2 Medium-term (1-6 months)	3 Regional	3 Medium probability
4 Low	1 Short-term (<1 month)	2 Local	2 Low probability
1 Minor		1 Site only	1 Improbable
			0 No chance of occurrence

Significance: Low ≤30; Low Medium 31– 52; High Medium 53 – 74; High ≥75. Positive: +. NSI No Significant Impact

4.1.7.2 Construction Phase (civil construction including drilling impacts)

Impacts are rated in Table 29 in accordance with the methodology described in Section 2.4.1.

Table 29: Construction phase impacts of noise (civil works of CPF complex and drilling)

Indicator of potential impact	Pre-mitigation					Post-mitigation				
	Magnitude	Duration	Geographic Extent	Probability	Significance	Magnitude	Duration	Geographic Extent	Probability	Significance
Daytime Impact of Drilling Noise	1 structure (5 people)				High	-				NSI
	42 structures (189 people)				Medium	-				NSI





NOISE IMPACT ASSESSMENT

Indicator of potential impact	Pre-mitigation					Post-mitigation				
	Magnitude	Duration	Geographic Extent	Probability	Significance	Magnitude	Duration	Geographic Extent	Probability	Significance
	173 buildings (779 people)				Low	1 structure (5 people)				Low
Nighttime Impact of Drilling Noise	216 buildings (223 people)				High	1 structure (5 people)				High
Nighttime Impact of Drilling Noise	568 buildings (2556 people)				Medium	42 structures (189 people)				Medium
Nighttime Impact of Drilling Noise	657 buildings (2956 people)				Low	173 structures (779 people)				Low
KEY (Note: The standard rating scale does not apply to drilling noise – refer to the methodology in Section 7.1.3.1)										
Magnitude	Duration		Scale		Probability					
10 Very high/ don't know	4	Permanent	5	International	5 Definite/don't know					
8 High	3	Long-term (>6 months)	4	National	4 Highly probable					
6 Medium	2	Medium-term (1-6 months)	3	Regional	3 Medium probability					
4 Low	1	Short-term (<1 month)	2	Local	2 Low probability					
1 Minor			1	Site only	1 Improbable					
					0 No chance of occurrence					
Significance: Low ≤30; Low Medium 31– 52; High Medium 53 – 74; High ≥75. Positive: +. NSI No Significant Impact										

4.1.7.3 Construction Phase (Feeder Pipeline)

The impacts of the feeder pipeline are divided into those associated with the work site and those associated with the personnel camp.

Table 30: Construction phase impacts of noise (feeder pipeline)

Indicator of potential impact	Pre-mitigation					Post-mitigation				
	Magnitude	Duration	Geographic Extent	Probability	Significance	Magnitude	Duration	Geographic Extent	Probability	Significance
Daytime Impact of Civil Construction Noise	11 buildings (50 people) 65 -70 dBA				Low	11 buildings (50 people) <65 dBA				NSI
Daytime Impact of Civil Construction Noise (9 buildings)	9 buildings (40 people) 55-60 dBA				Low	11 buildings (50 people) <65 dBA				NSI
Daytime Impact of Personnel Camp Noise	No household within 200 m				NSI	-				NSI
Night-time Impact of Personnel Camp Noise	No household within 200 m				NSI	-				NSI
KEY (Note: Standard rating scale does not apply to construction noise – refer to the methodology above)										
Magnitude	Duration		Scale		Probability					





10 Very high/ don't know	Merged into the magnitude ratings for construction-related noise	5 International	5 Definite/don't know
8 High		4 National	4 Highly probable
6 Medium		3 Regional	3 Medium probability
4 Low		2 Local	2 Low probability
1 Minor		1 Site only	1 Improbable
			0 No chance of occurrence

Significance: Low ≤30; Low Medium 31– 52; High Medium 53 – 74; High ≥75. Positive: +. NSI No Significant Impact

4.1.7.4 Operational Phase

The impacts described in Table 31 are for the long term operation of the production facility, after drilling is completed. Impacts are evaluated in accordance with the methodology described in Section 2.4.2.

Drilling during the first 5 years of the operational phase will result in the same impacts described in Section 4.1.7.2.

Table 31: Operational phase impacts of noise (excluding drilling)

Indicator of potential impact	Pre-mitigation					Post-mitigation				
	Magnitude	Duration	Geographic Extent	Probability	Significance	Magnitude	Duration	Geographic Extent	Probability	Significance
Impact of the CPF Operation (all villages)	1	4	1	5	Low 30	1	4	1	5	Low 30
Two households east of the CPF	4	4	2	5	Low Medium 50	-	-	-	-	NSI

KEY

Magnitude	Duration	Scale	Probability
10 Very high/ don't know	5 Permanent	5 International	5 Definite/don't know
8 High	4 Long-term (impact ceases after closure of activity)	4 National	4 Highly probable
6 Medium	3 Medium-term (5 to 15 years)	3 Regional	3 Medium probability
4 Low	2 Short-term (0 to 5 years)	2 Local	2 Low probability
2 Minor	1 Transient	1 Site only	1 Improbable
1 None/Negligible			0 No chance of occurrence

Significance: Low ≤30; Low Medium 31– 52; High Medium 53 – 74; High ≥75. Positive: +

5.0 RECOMMENDED CONTINUOUS MONITORING AND ADOPTION OF GOOD PRACTICE

5.1 Monitoring programme

The requirements of the monitoring program are anticipated to change throughout the lifespan of the Project. Each phase of the Project will affect receptors to a varying degree, depending on the active work areas, plant in use and hours of work.





During construction and drilling of wells, when the intensity of works is anticipated to be variable, monthly noise surveys will be undertaken at the receptors closest to the active work areas. Each receptor will be monitored for a period not less than 24 hours and the results compared with the evaluation criteria.

During the production stage, when noise levels are anticipated to be less variable, the frequency of monitoring will be reduced to annual surveys, with additional spot-checks of 1 hour's duration during the daytime and night-time at receptors conducted monthly. Supplementary 24-hour surveys will be conducted should noise complaints be received.

5.2 Noise control measures

In order to minimise noise generation at the site it is recommended that best practice is followed during the construction and operations phases of the Project. Noise mitigation should be incorporated into the design and operation of the Project, with noisy activities conducted during the daytime period and at locations far from receptors where possible. Items of equipment, both fixed and mobile, should be selected for lower noise models, where possible.

A programme of noise monitoring should be established at noise sensitive receptors, and measured levels compared with noise limits. Where exceedances are identified appropriate actions should be taken to reduce noise at the affected receptors.

6.0 CONCLUSION

This assessment has considered potential noise impacts associated with the proposed development of an oil facility in the Kingfisher Field on the shore of Lake Albert, Uganda.

International guidance and Ugandan legislation were reviewed in order to determine appropriate standards for construction and operational noise. In all cases, the Ugandan legal standard was used as the threshold for 'high' impact significance. Other guidelines for construction and operational impacts were also applied.

A baseline study of noise levels in the Kingfisher Field was completed in early 2014. Background noise levels in the study area were found to be lower than the Ugandan daytime guide of 55 dBA for mixed residential areas at all receptors. During the night-time period the background noise levels are typically between 32 dBA and 42 dBA.

Noise predictions were made in accordance with three distinct phases of the project; construction of infrastructure, drilling of wells and production. The decommissioning phase was not modelled, as decommissioning noise impacts have been assumed to be similar to or less than those arising from the construction of infrastructure.

Noise impacts associated with the different phases of the Project were assessed against the adopted evaluation criteria for construction and operational noise. Where initial noise impacts at the closest receptors to the proposed Project infrastructure were identified as significant, further modelling was undertaken and mitigation options considered.

Significant impacts are predicted at the nearby villages due to the construction of civil infrastructure on the Buhuka Flats, caused by the use of heavy mobile plant items for site clearance and levelling and other potentially noisy activities. Impact significance during the daytime will generally be low, taking into consideration that construction impacts are tolerated to a greater degree than long term impacts due to their transient nature. If noisy night work occurs, this will result in impacts of high, medium and low significance for surrounding inhabitants due to the more stringent criteria for the evaluation of such noise. No impacts exceeding the Ugandan standard for construction noise are expected. Mitigation specified includes limiting noisy construction works to the daytime period only and the use of 'silenced plant' with enhanced exhaust mufflers and application of additional silencing of the engine bays, and the training of personnel to minimise unnecessary noise generation. Residual impacts are predicted to be of low significance.

Significant impacts are predicted at the nearby villages due to drilling. This activity will negatively affect large numbers of people in varying degrees, from high to low significance. Specified mitigation measures to lower the impacts include the use of an acoustic curtain to enclose parts of the drill rig and acoustic screening of





ancillary plant at the level of the well pad. While this mitigation is expected to lower noise levels by around 10 dBA, residual noise levels will still exceed the project standard and the legal limits for construction at many households, mainly during the night time period when sleep disturbance is an issue. As a result, it is recommended that the worst affected households are temporarily relocated during drilling.

Potential impacts are predicted for a small number of residents along the feeder pipeline as a result of their proximity to ongoing construction at the work sites. Impact will generally be over a short period, often only a few weeks. Mitigation includes measures to limit source noise and to train vehicle and equipment operators to be considerate of nearby local households. Additional measures may be required where sensitive land uses are affected. Subject to the range of specified mitigation, it is predicted that impacts can be reduced to low levels of significance.

The static nature of the noise sources during the production phase has enabled the specification of enhanced noise attenuating housings for fixed plant items. These measures are predicted to reduce noise at the closest receptors to low or negligible levels of significance during the production phase, with the exception of two building structures to the east and south east of the CPF. It is recommended that these households are resettled further from the boundary of the CPF.

7.0 REFERENCES

- 1) Scoping Report for the Environmental and Social Impact Assessment for Kingfisher Discovery Area in Hoima District, Uganda, by CNOOC Uganda Ltd. - Golder Associates and Eco & Partner, December 2013
- 2) Kingfisher Field Development Plan – CNOOC, September 2012.
- 3) National Environment (Noise Standards and Control) Regulation, 2003. Ugandan Government, 2003.
- 4) Environmental Health and Safety Guidelines, Noise. International Finance Corporation, 2007.
- 5) BS 5228:1 – 2009: Code of practice for noise and vibration control on construction and open sites. British Standards Institute, 2009.
- 6) Attenuation of sound during propagation outdoors. International Standards Institute, 1993.





Author: Simon Waddell
Noise Consultant
BSc(Hons) MIOA, Postgraduate Diploma in
Acoustics and Noise Control

Senior review: Stuart McGowan
Senior EIA, Air Quality & Noise Consultant
Chemical and Process Engineering BEng
Hons 1998; Environmental Management
Systems PG Diploma 1999



APPENDIX A

Noise Sources Modelled

Construction phase - export pipeline - area source 1 km long & 20m wide

Plant	Resultant sound power level, dB			Number of moving point sources within area		
	Day	Evening	Night	Number		
	(dBA)	(dBA)	(dBA)	Day	Evening	Night
30T Excavator	107.5	107.5	-	4	4	-
100T crane	102.1	102.1	-	2	2	-
Dozer	111.7	111.7	-	2	2	-
LowLoader	111.1	111.1	-	2	2	-
Welder	103.9	103.9	-	2	2	-

Construction phase - CPF & well pad construction

Plant	Resultant sound power level, dB			Number of moving point sources within area		
	Day	Evening	Night	Number		
	(dBA)	(dBA)	(dBA)	Day	Evening	Night
Excavators 30T	104.5	104.5	-	2	2	-
Crane 100T	99.1	99.1	-	1	1	-
Bulldozers 20T	111.7	111.7	-	2	2	-
Wagons	111.1	111.1	-	2	2	-
Vibrating roller	101.5	101.5	-	1	1	-
OtherPlant (10T telehandler)	101.5	101.5	-	2	2	-

Drilling Phase					
Name	Resultant sound power level, dB			Lw / Li	
	Day	Evening	Night	Type	Value
	(dBA)	(dBA)	(dBA)		
Well pad plant:					
Water Pump 1	90	80	80	Lw	90
Water Pump 2	90	80	80	Lw	90
Water Pump 3	90	80	80	Lw	90
Drill Rig 1 top drive	111	81	81	Lw	111
Drill Rig 1 engine	114	84	84	Lw	114
Mud Pump 1	109	79	79	Lw	109
Telehandler 1	99	89	89	Lw	99
Lighting rig 1	93	83	83	Lw	93
100 kVA generator 1	105	95	95	Lw	105
CPF plant					
Genset 1	88	88	88	Lw	88
Genset 2	88	88	88	Lw	88
Genset 1	88	88	88	Lw	88
Genset 2	88	88	88	Lw	88
Genset 3	88	88	88	Lw	88
Water treatment system	88	88	88	Lw	88
Substation	88	88	88	Lw	88
Oil Separation System	88	88	88	Lw	88
Flash Gas Compressor	88	88	88	Lw	88
Fuel Gas Compressor	88	88	88	Lw	88
Excess Gas Utilisation Package	88	88	88	Lw	88
Water Injection Pumping System	88	88	88	Lw	88
Kingfisher Main Inlet & Water Injectio	88	88	88	Lw	88
Kingfisher North Inlet & Water Inject	88	88	88	Lw	88
Oil Transmission Pumps & Metering	88	88	88	Lw	88
Oil Heating Medium	88	88	88	Lw	88
Oil Export System	88	88	88	Lw	88

Raw Water System	88	88	88	Lw	88
------------------	----	----	----	----	----

Production phase

Name	Result. PWL			Lw / Li	Value	Height (m)	Coordinates		
	Day	Evening	Night				Type	X	Y
	(dBA)	(dBA)	(dBA)					(m)	(m)
Genset 1	88	88	88	Lw	88	2	250051	137953.3	
Genset 2	88	88	88	Lw	88	2	250017	137957.5	
Genset 1	88	88	88	Lw	88	3	250064.3	137920.6	
Genset 2	88	88	88	Lw	88	3	250032.9	137926.8	
Genset 3	88	88	88	Lw	88	3	249999	137935.6	
Water treatment system	88	88	88	Lw	88	3	250090	138106.5	
Substation	88	88	88	Lw	88	3	250046.9	137879	
Oil Separation System	88	88	88	Lw	88	3	249968.7	137664.3	
Flash Gas Compressor	88	88	88	Lw	88	3	249829	137801.4	
Fuel Gas Compressor	88	88	88	Lw	88	3	249832.8	137831	
Excess Gas Utilisation Package	88	88	88	Lw	88	3	249840.3	137879.9	
Water Injection Pumping System	88	88	88	Lw	88	3	249856.2	137613.1	
Kingfisher Main Inlet & Water Injection	88	88	88	Lw	88	3	249820.1	137580.2	
Kingfisher North Inlet & Water Injection	88	88	88	Lw	88	3	249618.1	137672.6	
Oil Transmission Pumps & Metering	88	88	88	Lw	88	3	249637.2	137821.5	
Oil Heating Medium	88	88	88	Lw	88	3	249751	137772.6	
Oil Export System	88	88	88	Lw	88	3	249928.5	137555.7	
Raw Water System	88	88	88	Lw	88	3	249857.8	138023.2	
WP4A (area source)	65	65	65	Lw	75	1	250314.9	139780.7	
WP2 (area source)	72	72	72	Lw	75	1	249566.2	138806.4	
WP1 (area source)	70	70	70	Lw	75	1	248638.7	137922.4	
WP3 (area source)	74	74	74	Lw	75	1	247575.3	136155.4	



APPENDIX B

Baseline – Measured Levels & Graphs

NMP															
1	Daytime							Night-time							
		L _{Aeq,1hr}	L _{Aeq,10min}	L _{Aeq,16hr}	L _{A90,1hr}	L _{A90,10min}	L _{A90,16hr}	Max	L _{Aeq,1hr}	L _{Aeq,10min}	L _{Aeq,8hr}	Max	L _{A90,1hr}	L _{A90,10min}	L _{A90,8hr}
1	Max							Max				Max			
	Min							Min				Min			
	Ave	55.7						Ave	0.0						
2	Daytime							Night-time							
		L _{Aeq,1hr}	L _{Aeq,10min}	L _{Aeq,16hr}	L _{A90,1hr}	L _{A90,10min}	L _{A90,16hr}	Max	L _{Aeq,1hr}	L _{Aeq,10min}	L _{Aeq,8hr}	Max	L _{A90,1hr}	L _{A90,10min}	L _{A90,8hr}
2	Max	61.5	65.8		47.9	49.9		Max	54.9	61.7		Max	42.3	45.3	
	Min	45.6	41.8		37.0	34.9		Min	39.5	34.0		Min	32.2	24.5	
				54.6			44.5				49.9				39.1
3	Daytime							Night-time							
		L _{Aeq,1hr}	L _{Aeq,10min}	L _{Aeq,16hr}	L _{A90,1hr}	L _{A90,10min}	L _{A90,16hr}	Max	L _{Aeq,1hr}	L _{Aeq,10min}	L _{Aeq,8hr}	Max	L _{A90,1hr}	L _{A90,10min}	L _{A90,8hr}
3	Max							Max				Max			
	Min							Min				Min			
	Ave	44.1						Ave	45.5						
4	Daytime							Night-time							
		L _{Aeq,1hr}	L _{Aeq,10min}	L _{Aeq,16hr}	L _{A90,1hr}	L _{A90,10min}	L _{A90,16hr}	Max	L _{Aeq,1hr}	L _{Aeq,10min}	L _{Aeq,8hr}	LA90	L _{A90,1hr}	L _{A90,10min}	L _{A90,8hr}
4	Max	61.8	64.1		60.8	62.6		Max	62.0	63.4		Max	60.7	62.6	
	Min	42.2	38.1		29.7	28.0		Min	42.3	40.5		Min	38.2	37.6	
				54.4			49.4				56.4				54.4
5	Daytime							Night-time							
		L _{Aeq,1hr}	L _{Aeq,10min}	L _{Aeq,16hr}	L _{A90,1hr}	L _{A90,10min}	L _{A90,16hr}	LAeq	L _{Aeq,1hr}	L _{Aeq,10min}	L _{Aeq,8hr}	LA90	L _{A90,1hr}	L _{A90,10min}	L _{A90,8hr}
5	Max	57.5	61.0		48.0	51.9		LAeq	45.9	50.6		LA90	43.0	44.1	
	Min	42.2	38.9		35.7	33.6		Min	42.1	40.8		Min	39.0	35.4	
				49.8			40.6				43.6				41.2
6	Daytime							Night-time							
		L _{Aeq,1hr}	L _{Aeq,10min}	L _{Aeq,16hr}	L _{A90,1hr}	L _{A90,10min}	L _{A90,16hr}	LAeq	L _{Aeq,1hr}	L _{Aeq,10min}	L _{Aeq,8hr}	LA90	L _{A90,1hr}	L _{A90,10min}	L _{A90,8hr}
6	Max	64.1	69.9		50.1	56.3		LAeq	46.2	47.4		LA90	42.4	43.8	
	Min	36.6	33.3		25.2	23.4		Min	36.6	34.2		Min	33.1	31.7	
				53.0			41.1				42.3				38.0
7	Daytime							Night-time							
		L _{Aeq,1hr}	L _{Aeq,10min}	L _{Aeq,16hr}	L _{A90,1hr}	L _{A90,10min}	L _{A90,16hr}	LAeq	L _{Aeq,1hr}	L _{Aeq,10min}	L _{Aeq,8hr}	LA90	L _{A90,1hr}	L _{A90,10min}	L _{A90,8hr}
7	Max	55.6	58.3		48.6	52.0		LAeq	45.6	49.9		LA90	40.1	41.0	
	Min	42.0	38.3		30.7	29.5		Min	39.4	37.3		Min	35.0	33.0	
				49.9			40.3				42.9				37.5
8	Daytime							Night-time							
		L _{Aeq,1hr}	L _{Aeq,10min}	L _{Aeq,16hr}	L _{A90,1hr}	L _{A90,10min}	L _{A90,16hr}	LAeq	L _{Aeq,1hr}	L _{Aeq,10min}	L _{Aeq,8hr}	LA90	L _{A90,1hr}	L _{A90,10min}	L _{A90,8hr}
8	Max	53.4	74.5		44.8	46.6		LAeq	51.7	52.3		LA90	50.2	51.0	
	Min	42.1	37.1		31.0	29.5		Min	44.8	40.3		Min	41.6	38.3	
				55.8			39.9				48.5				46.4
9	Daytime							Night-time							
		L _{Aeq,1hr}	L _{Aeq,10min}	L _{Aeq,16hr}	L _{A90,1hr}	L _{A90,10min}	L _{A90,16hr}	LAeq	L _{Aeq,1hr}	L _{Aeq,10min}	L _{Aeq,8hr}	LA90	L _{A90,1hr}	L _{A90,10min}	L _{A90,8hr}
9	Max	59.2	69.7		46.0	52.7		LAeq	51.8	55.0		LA90	43.2	44.5	
	Min	43.8	36.9		29.5	28.2		Min	42.4	40.5		Min	36.3	34.7	
				55.4			41.0				47.3				41.6
10	Daytime							Night-time							
		L _{Aeq,1hr}	L _{Aeq,10min}	L _{Aeq,16hr}	L _{A90,1hr}	L _{A90,10min}	L _{A90,16hr}	LAeq	L _{Aeq,1hr}	L _{Aeq,10min}	L _{Aeq,8hr}	LA90	L _{A90,1hr}	L _{A90,10min}	L _{A90,8hr}
10	Max	57.3	62.9		52.9	55.4		LAeq	51.9	52.8		LA90	48.9	51.3	
	Min	44.9	36.7		34.7	31.2		Min	40.6	39.4		Min	34.6	31.5	
				52.1			44.7				47.9				44.3
11	Daytime							Night-time							
		L _{Aeq,1hr}	L _{Aeq,10min}	L _{Aeq,16hr}	L _{A90,1hr}	L _{A90,10min}	L _{A90,16hr}	LAeq	L _{Aeq,1hr}	L _{Aeq,10min}	L _{Aeq,8hr}	LA90	L _{A90,1hr}	L _{A90,10min}	L _{A90,8hr}
11	Max	53.5	58.1		51.7	53.1		LAeq	50.9	51.7		LA90	49.8	50.6	
	Min	36.1	32.5		28.4	26.5		Min	46.0	45.8		Min	44.9	44.8	
				49.0			44.6				49.7				48.5
12	Daytime							Night-time							
		L _{Aeq,1hr}	L _{Aeq,10min}	L _{Aeq,16hr}	L _{A90,1hr}	L _{A90,10min}	L _{A90,16hr}	LAeq	L _{Aeq,1hr}	L _{Aeq,10min}	L _{Aeq,8hr}	LA90	L _{A90,1hr}	L _{A90,10min}	L _{A90,8hr}
12	Max	52.9	59.7		49.5	51.2		LAeq	48.6	50.3		LA90	46.6	47.6	
	Min	36.6	34.7		30.8	29.2		Min	38.7	37.3		Min	36.7	35.7	
				48.2			42.3				46.0				43.2

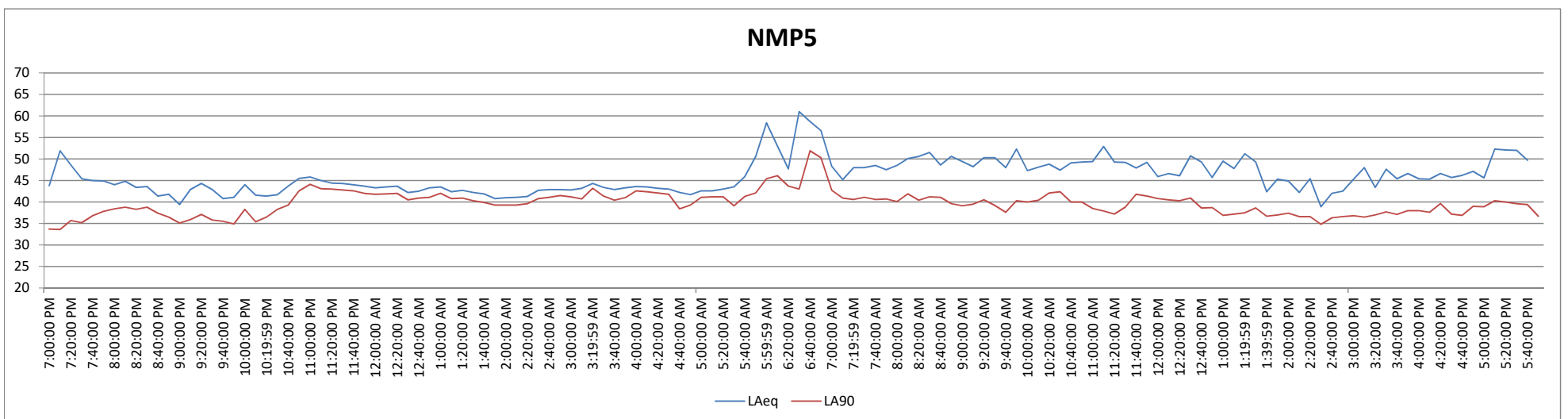
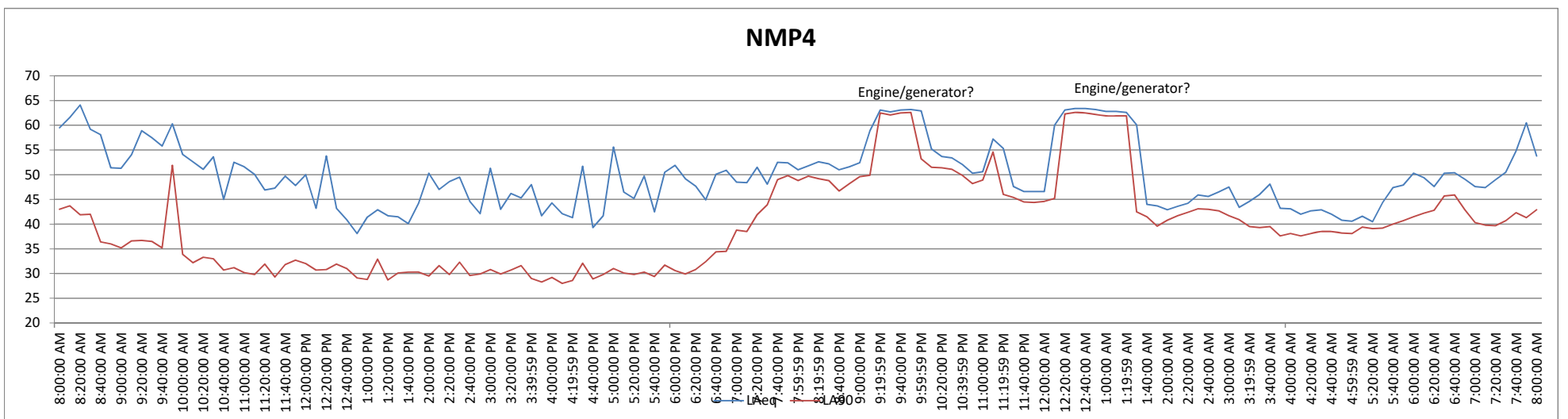
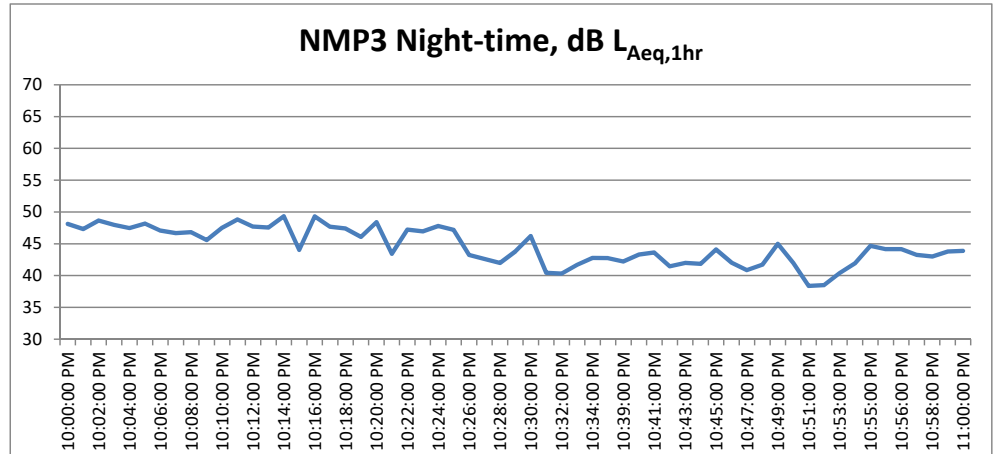
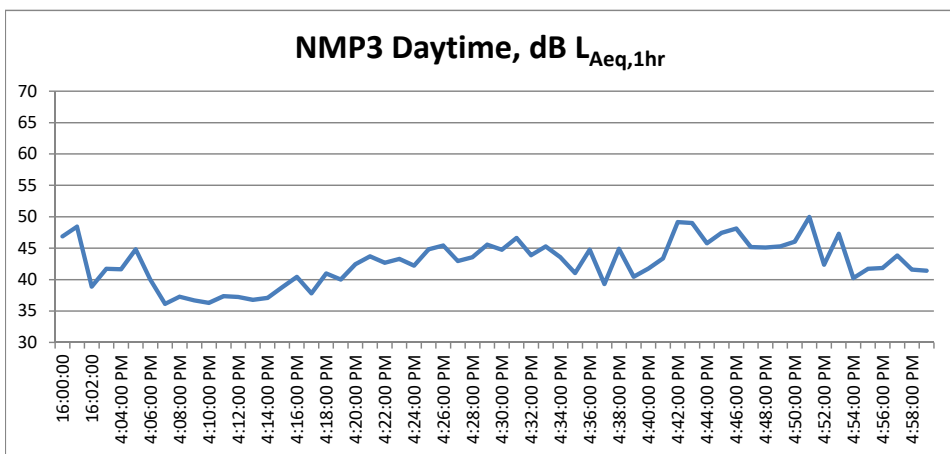
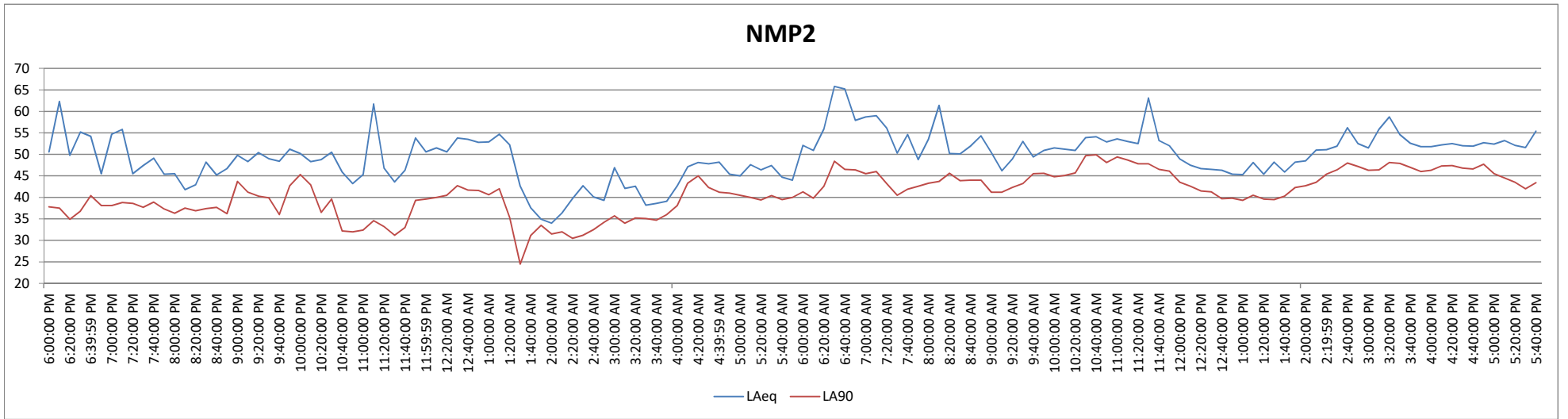
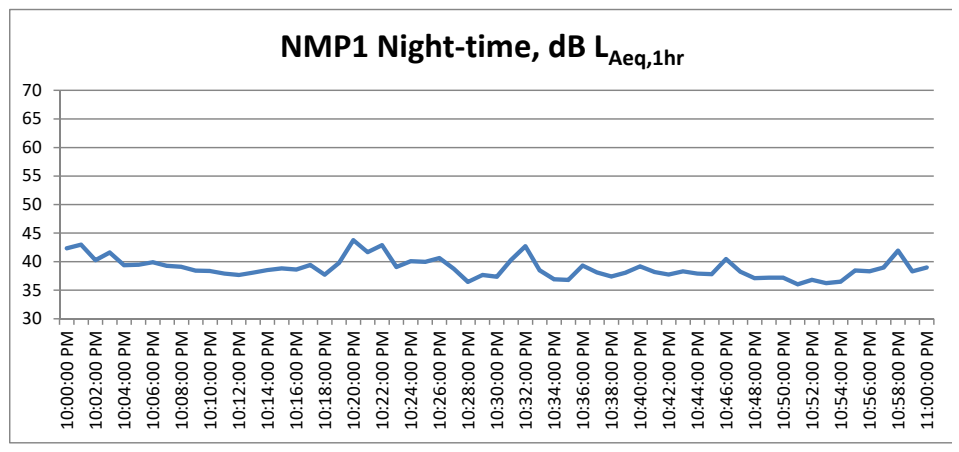
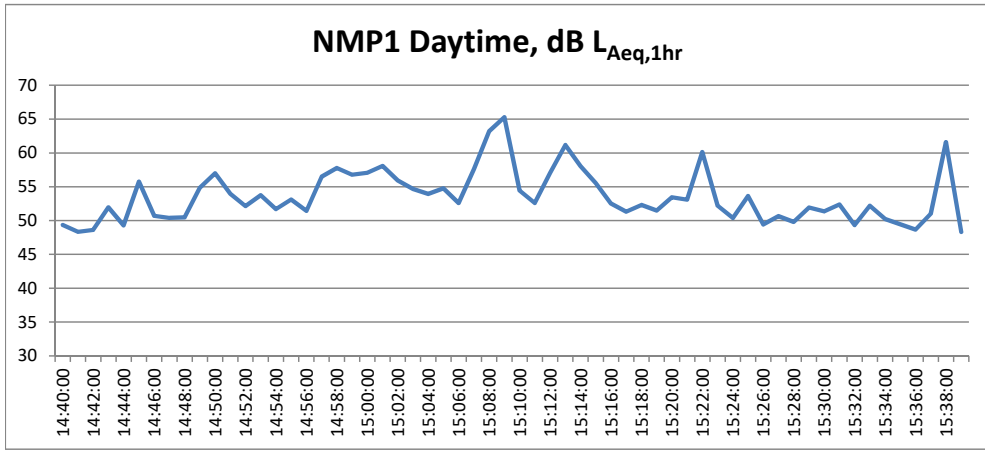

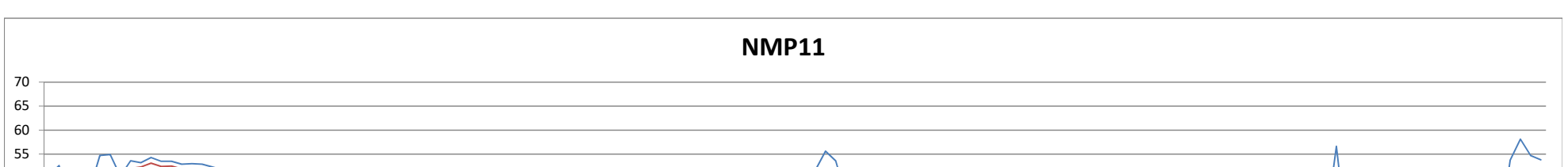
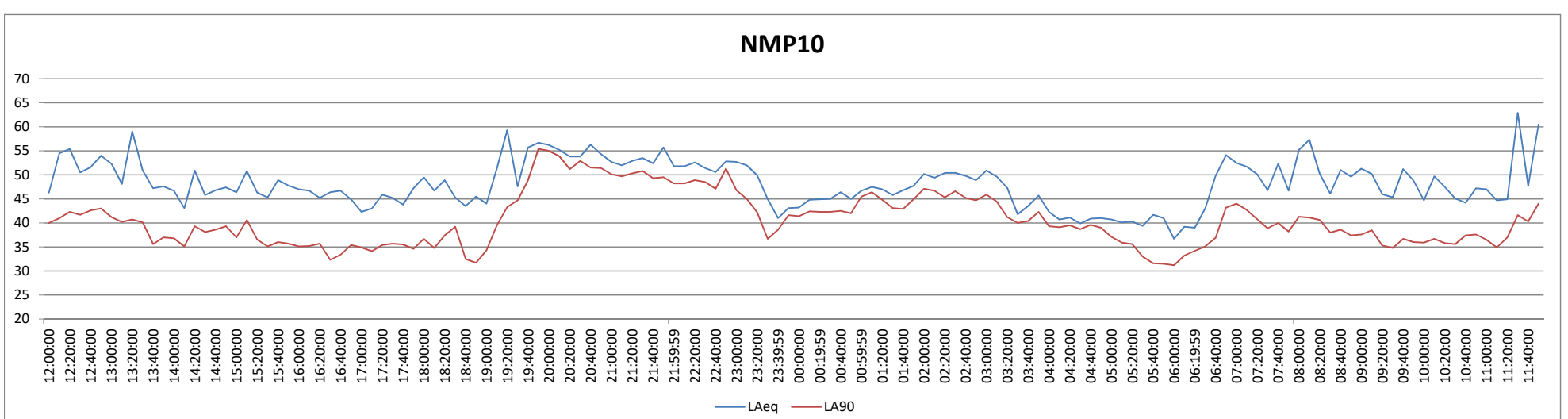
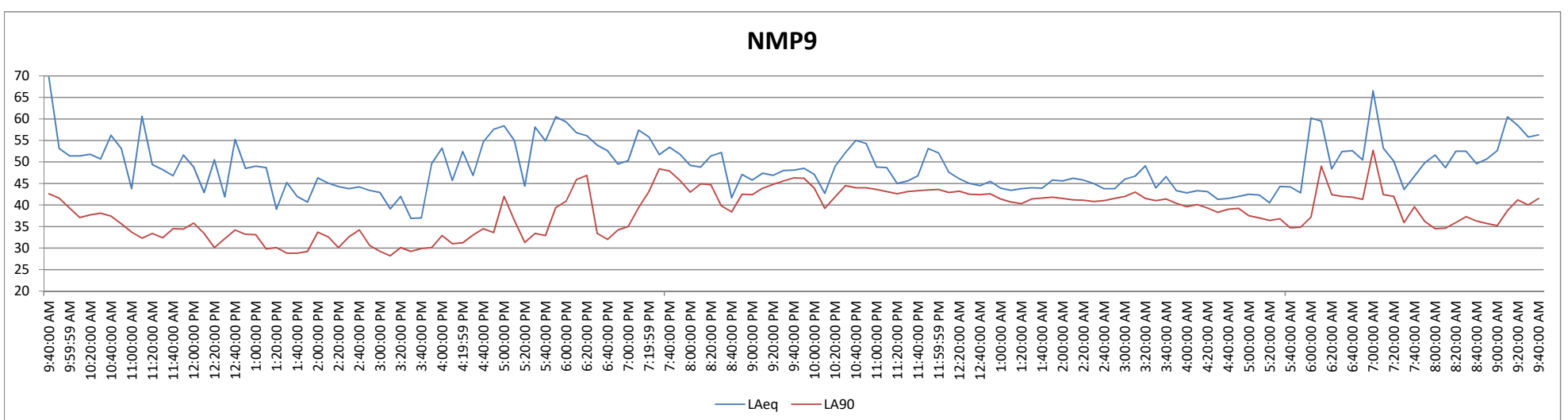
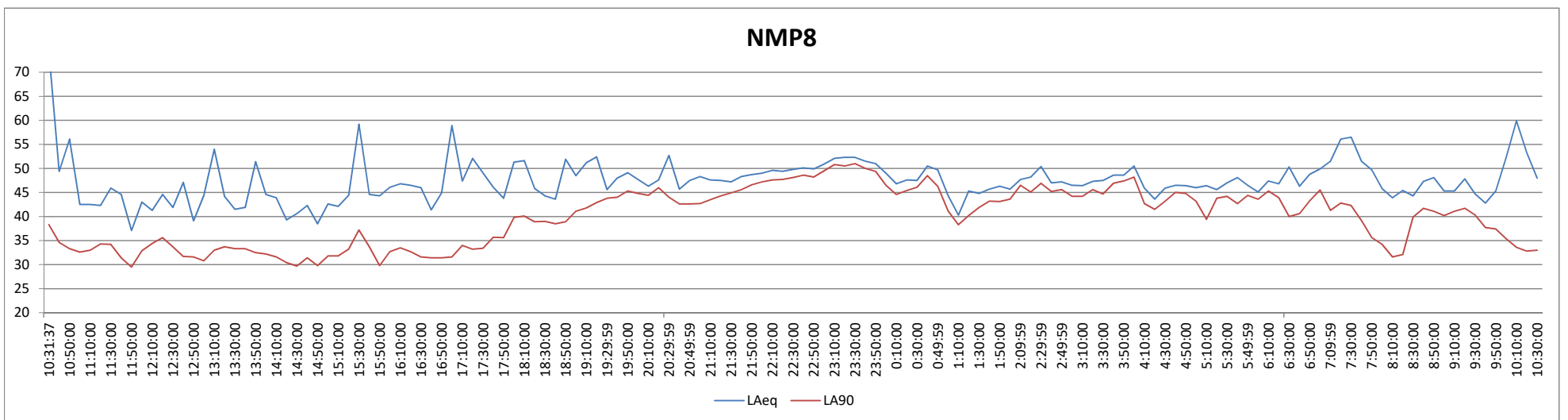
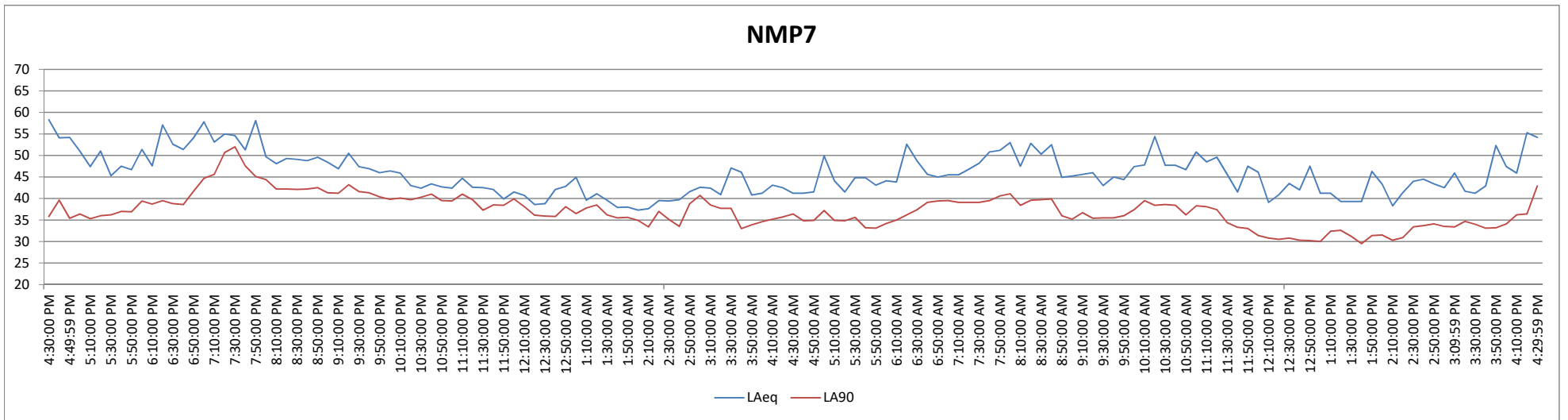
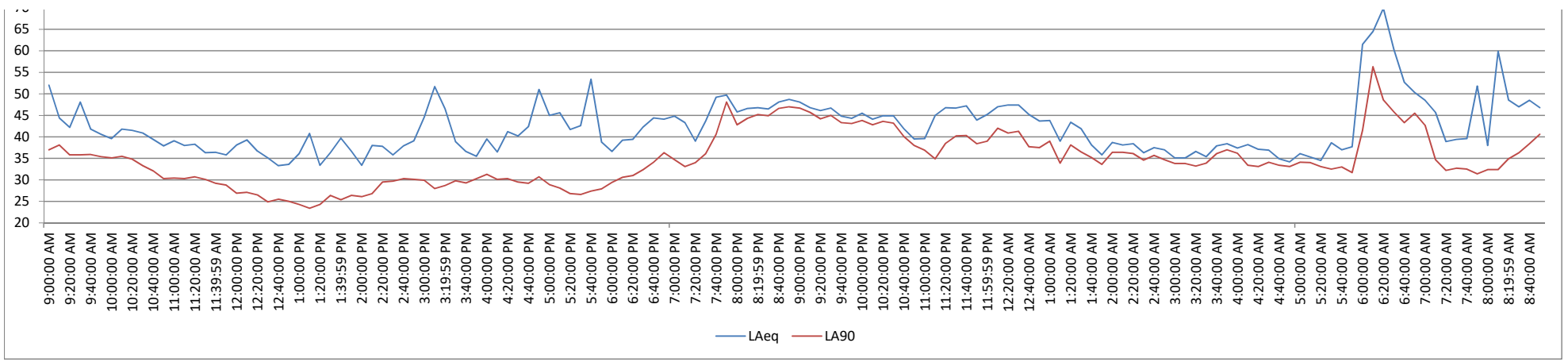

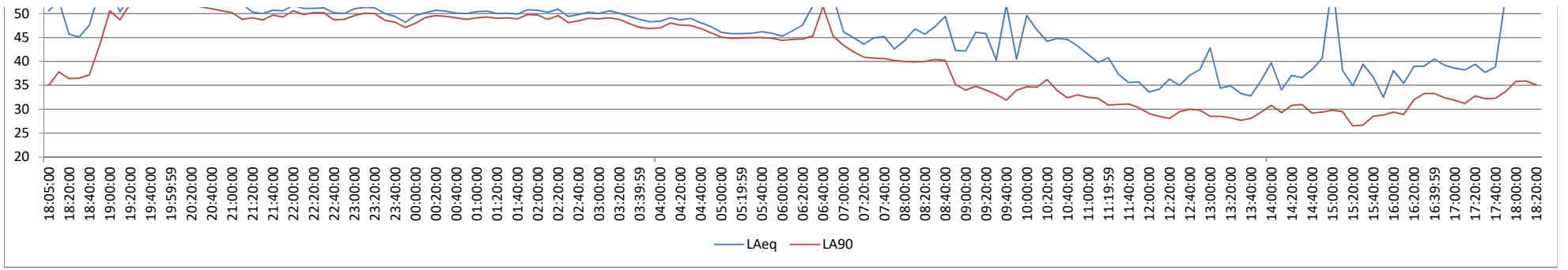

NMP12

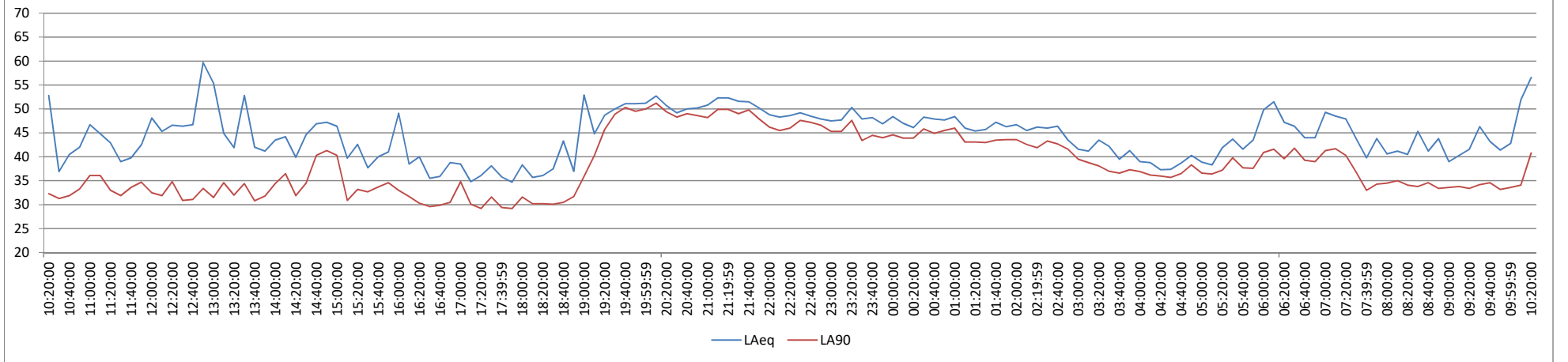



APPENDIX C

Predicted Noise Levels by Receptor

CONSTRUCTION PREDICTIONS

Post-mitigation		
Name	Level Lr	
	Day (dBA)	Night (dBA)
Pad 4_2 - nearest receptor	72.6	0.0
Pad2 - nearest receptor	54.4	0.0
Kyabasambu nearest receptor	48.9	0.0
Wellpad1 - nearest receptor	54.0	0.0
Nsonga North	43.4	0.0
Nsonga South	54.0	0.0
Pad 3 nearest receptor - Nsunzu north	48.6	0.0
Pad 5 - nearest receptor	66.4	0.0
Kiina closest receptor	36.3	0.0
Ikamiro Village	54.0	0.0

DRILLING PREDICTIONS

SUMMARY OF WORST-CASE DRILLING NOISE									
Pre-mitigation						Post-mitigation			
Name	ID	Level Lr Day (dBA)	Night (dBA)	Identified Receptor		Name	ID	Level Lr Day (dBA)	Night (dBA)
				village	Source				
Pad 4_2 - nearest receptor	R1	80.8	80.8	Kyakapere	Pad 4_2	Pad 4_2 - nearest receptor	R1	70.0	70.0
Pad2 - nearest receptor	R2	58.4	58.4	Kyakapere	Pad 2	Pad2 - nearest receptor	R2	46.2	46.2
Kyabasambu - nearest receptor	R3	58.0	58.0	Kyabasambu	Pad 2	Kyabasambu - nearest receptor	R3	44.4	44.4
Wellpad1 - nearest receptor	R4	64.1	64.1	Kyabasambu	Pad 1	Wellpad1 - nearest receptor	R4	52.7	52.7
Nsonga North	R5	51.2	51.2	Nsonga	Pad 1	Nsonga North	R5	41.2	41.2
Nsonga South	R5	67.9	67.9	Nsonga	Pad 3	Nsonga South	R6	55.1	55.1
Pad 3 nearest receptor - Nsunzu north	R7	57.5	57.5	Nsunzu	Pad 3	Pad 3 nearest receptor - Nsunzu north	R7	46.7	46.7
Pad 5 - nearest receptor	R9	79.5	79.5	Kiina	Pad 5	Pad 5 - nearest receptor	R9	62.9	62.9
Kiina closest receptor	R10	47.5	47.5	Kiina	Pad 5	Kiina closest receptor	R10	39.0	39.0
Ikamiro Village	NMP11	24.3	23.4	Ikamiro	Pad 1	Ikamiro Village	R8	15.2	14.5

DRILLING NOISE BY WELLPAD									
Wellpad 1						Wellpad 1			
Name	ID	Level Lr Day (dBA)	Night (dBA)	Identified Receptor		Name	ID	Level Lr Day (dBA)	Night (dBA)
				village	area				
Pad 4_2 - nearest receptor	R1	25.6	25.6	Kyakapere	north	Pad 4_2 - nearest receptor	R1	19.4	19.4
Pad2 - nearest receptor	R2	38.6	38.6	Kyakapere	south	Pad2 - nearest receptor	R2	33.9	33.9
Kyabasambu - nearest receptor	R3	47.3	47.3	Kyabasambu	north	Kyabasambu - nearest receptor	R3	39.4	39.4
Wellpad1 - nearest receptor	R4	64.1	64.1	Kyabasambu	south	Wellpad1 - nearest receptor	R4	52.7	52.7
Nsonga North	R5	51.2	51.2	Nsonga	north	Nsonga North	R5	41.2	41.2
Nsonga South	R6	36.0	36.0	Nsonga	south	Nsonga South	R6	30.4	30.4
Pad 3 nearest receptor - Nsunzu north	R7	32.7	32.7	Nsunzu	north	Pad 3 nearest receptor - Nsunzu north	R7	27.5	27.5
Pad 5 - nearest receptor	R9	22.6	22.6	Kiina	north	Pad 5 - nearest receptor	R9	18.6	18.6
Kiina closest receptor	R10	20.9	20.9	Kiina	south	Kiina closest receptor	R10	16.6	16.6
Ikamiro Village	R8/NMP11	24.3	23.4	Ikamiro	Pad 1	R8/NMP11	NMP11	15.2	14.5

Wellpad 2						Wellpad 2			
Name	ID	Level Lr Day (dBA)	Night (dBA)	Identified Receptor		Name	ID	Level Lr Day (dBA)	Night (dBA)
				village	area				
Pad 4_2 - nearest receptor	R1	32.1	32.1	Kyakapere	north	Pad 4_2 - nearest receptor	R1	25.8	25.8
Pad2 - nearest receptor	R2	58.4	58.4	Kyakapere	south	Pad2 - nearest receptor	R2	46.2	46.2
Kyabasambu - nearest receptor	R3	58.0	58.0	Kyabasambu	north	Kyabasambu - nearest receptor	R3	44.4	44.4
Wellpad1 - nearest receptor	R4	43.4	43.4	Kyabasambu	south	Wellpad1 - nearest receptor	R4	34.6	34.6
Nsonga North	R5	35.7	35.7	Nsonga	north	Nsonga North	R5	28.5	28.5
Nsonga South	R6	27.4	27.4	Nsonga	south	Nsonga South	R6	23.0	23.0
Pad 3 nearest receptor - Nsunzu north	R7	25.7	25.7	Nsunzu	north	Pad 3 nearest receptor - Nsunzu north	R7	20.8	20.8
Pad 5 - nearest receptor	R9	16.7	16.7	Kiina	north	Pad 5 - nearest receptor	R9	11.1	11.1
Kiina closest receptor	R10	15.5	15.5	Kiina	south	Kiina closest receptor	R10	11.0	11.0
Ikamiro Village	R8/NMP10	23.7	22.8	Ikamiro	-	Ikamiro Village	R8/NMP10	11.8	11.5

Wellpad 3						Wellpad 3			
Name	ID	Level Lr Day (dBA)	Night (dBA)	Identified Receptor		Name	ID	Level Lr Day (dBA)	Night (dBA)
				village	area				
Pad 4_2 - nearest receptor	R1	16.3	16.3	Kyakapere	north	Pad 4_2 - nearest receptor	R1	10.9	10.9
Pad2 - nearest receptor	R2	27.3	27.3	Kyakapere	south	Pad2 - nearest receptor	R2	24.4	24.4
Kyabasambu - nearest receptor	R3	30.5	30.5	Kyabasambu	north	Kyabasambu - nearest receptor	R3	28.3	28.3
Wellpad1 - nearest receptor	R4	34.4	34.4	Kyabasambu	south	Wellpad1 - nearest receptor	R4	29.7	29.7
Nsonga North	R5	40.7	40.7	Nsonga	north	Nsonga North	R5	33.5	33.5
Nsonga South	R6	67.9	67.9	Nsonga	south	Nsonga South	R6	55.1	55.1
Pad 3 nearest receptor - Nsunzu north	R7	57.5	57.5	Nsunzu	north	Pad 3 nearest receptor - Nsunzu north	R7	46.7	46.7
Pad 5 - nearest receptor	R9	37.1	37.1	Kiina	north	Pad 5 - nearest receptor	R9	32.8	32.8
Kiina closest receptor	R10	34.7	34.7	Kiina	south	Kiina closest receptor	R10	28.3	28.3
Ikamiro Village	R8/NMP10	22.9	22.0	Ikamiro	-	Ikamiro Village	R8/NMP10	13	12.5

Wellpad 4-2						Wellpad 4-2			
Name	ID	Level Lr Day (dBA)	Night (dBA)	Identified Receptor		Name	ID	Level Lr Day (dBA)	Night (dBA)
				village	area				
Pad 4_2 - nearest receptor	R1	80.8	80.8	Kyakapere	north	Pad 4_2 - nearest receptor	R1	70.0	70.0
Pad2 - nearest receptor	R2	36.5	36.5	Kyakapere	south	Pad2 - nearest receptor	R2	27.0	27.0
Kyabasambu - nearest receptor	R3	33.9	33.9	Kyabasambu	north	Kyabasambu - nearest receptor	R3	27.6	27.6
Wellpad1 - nearest receptor	R4	30.5	30.5	Kyabasambu	south	Wellpad1 - nearest receptor	R4	25.6	25.6
Nsonga North	R5	25.4	25.4	Nsonga	north	Nsonga North	R5	19.0	19.0
Nsonga South	R6	17.1	17.1	Nsonga	south	Nsonga South	R6	12.1	12.1
Pad 3 nearest receptor - Nsunzu north	R7	17.5	17.5	Nsunzu	north	Pad 3 nearest receptor - Nsunzu north	R7	10.5	10.5
Pad 5 - nearest receptor	R9	5.7	5.7	Kiina	north	Pad 5 - nearest receptor	R9	4.5	4.5
Kiina closest receptor	R10	7.3	7.3	Kiina	south	Kiina closest receptor	R10	2.6	2.6
Ikamiro Village	R8/NMP10	14.7	14.7	Ikamiro	-	Ikamiro Village	R8/NMP10	9.6	9.5

Wellpad 5						Wellpad 5			
Name	ID	Level Lr Day (dBA)	Night (dBA)	Identified Receptor		Name	ID	Level Lr Day (dBA)	Night (dBA)
				village	area				
Pad 4_2 - nearest receptor	R1	8.2	8.2	Kyakapere	north	Pad 4_2 - nearest receptor	R1	6.3	6.3
Pad2 - nearest receptor	R2	23.0	23.0	Kyakapere	south	Pad2 - nearest receptor	R2	22.4	22.4
Nsunzu nearest receptor	R3	27.0	27.0	Kyabasambu	north	Kyabasambu - nearest receptor	R3	26.6	26.6
Wellpad1 - nearest receptor	R4	27.5	27.5	Kyabasambu	south	Wellpad1 - nearest receptor	R4	25.8	25.8
Nsonga North	R5	26.8	26.8	Nsonga	north	Nsonga North	R5	23.6	23.6
Nsonga South	R6	36.9	36.9	Nsonga	south	Nsonga South	R6	32.2	32.2
Pad 3 nearest receptor - Nsunzu north	R7	40.9	40.9	Nsunzu	north	Pad 3 nearest receptor - Nsunzu north	R7	35.6	35.6
Pad 5 - nearest receptor	R9	79.5	79.5	Kiina	north	Pad 5 - nearest receptor	R9	62.9	62.9
Kiina closest receptor	R10	47.5	47.5	Kiina	south	Kiina closest receptor	R10	39	39
Ikamiro Village	R8/NMP10	18.6	18.6	Ikamiro	-	Ikamiro Village	R8/NMP10	11.6	11.2

PRODUCTION PREDICTIONS

Post-mitigation			
Name	ID	Level Lr	
		Day (dBA)	Night (dBA)
Pad 4_2 - nearest receptor	R1	23.5	23.5
Pad2 - nearest receptor	R2	17.6	17.6
Kyabasambu nearest receptor	R3	22.2	22.2
Wellpad1 - nearest receptor	R4	25.3	25.3
Nsonga North	R5	17.2	17.2
Nsonga South	R6	8.8	8.8
Pad 3 nearest receptor - Nsunzu north	R7	15.0	15.0
Pad 5 - nearest receptor	R9	14.1	14.1
Kiina closest receptor	R10	18.2	18.2
Ikamiro Village	R11	27.4	27.4



APPENDIX D

Predicted noise contours of construction and drilling phases

SUMMARY OF WORST-CASE DRILLING NOISE									
Pre-mitigation						Post-mitigation			
Name	ID	Level Lr Day (dBA)	Night (dBA)	Identified Receptor village	Source	Name	ID	Level Lr Day (dBA)	Night (dBA)
Pad 4_2 - nearest receptor	R1	80.8	80.8	Kyakapere	Pad 4_2	Pad 4_2 - nearest receptor	R1	70.0	70.0
Pad2 - nearest receptor	R2	58.4	58.4	Kyakapere	Pad 2	Pad2 - nearest receptor	R2	46.2	46.2
Kyabasambu - nearest receptor	R3	58.0	58.0	Kyabasambu	Pad 2	Kyabasambu - nearest receptor	R3	44.4	44.4
Wellpad1 - nearest receptor	R4	64.1	64.1	Kyabasambu	Pad 1	Wellpad1 - nearest receptor	R4	52.7	52.7
Nsonga North	R5	51.2	51.2	Nsonga	Pad 1	Nsonga North	R5	41.2	41.2
Nsonga South	R5	67.9	67.9	Nsonga	Pad 3	Nsonga South	R6	55.1	55.1
Pad 3 nearest receptor - Nsunzu north	R7	57.5	57.5	Nsunzu	Pad 3	Pad 3 nearest receptor - Nsunzu north	R7	46.7	46.7
Pad 5 - nearest receptor	R9	79.5	79.5	Kiina	Pad 5	Pad 5 - nearest receptor	R9	62.9	62.9
Kiina closest receptor	R10	47.5	47.5	Kiina	Pad 5	Kiina closest receptor	R10	39.0	39.0
Ikamiro Village	NMP11	24.3	23.4	Ikamiro	Pad 1	Ikamiro Village	R8	15.2	14.5
DRILLING NOISE BY WELLPAD									
Wellpad 1						Wellpad 1			
Name	ID	Level Lr Day (dBA)	Night (dBA)	Identified Receptor village	area	Name	ID	Level Lr Day (dBA)	Night (dBA)
Pad 4_2 - nearest receptor	R1	25.6	25.6	Kyakapere	north	Pad 4_2 - nearest receptor	R1	19.4	19.4
Pad2 - nearest receptor	R2	38.6	38.6	Kyakapere	south	Pad2 - nearest receptor	R2	33.9	33.9
Kyabasambu - nearest receptor	R3	47.3	47.3	Kyabasambu	north	Kyabasambu - nearest receptor	R3	39.4	39.4
Wellpad1 - nearest receptor	R4	64.1	64.1	Kyabasambu	south	Wellpad1 - nearest receptor	R4	52.7	52.7
Nsonga North	R5	51.2	51.2	Nsonga	north	Nsonga North	R5	41.2	41.2
Nsonga South	R6	36.0	36.0	Nsonga	south	Nsonga South	R6	30.4	30.4
Pad 3 nearest receptor - Nsunzu north	R7	32.7	32.7	Nsunzu	north	Pad 3 nearest receptor - Nsunzu north	R7	27.5	27.5
Pad 5 - nearest receptor	R9	22.6	22.6	Kiina	north	Pad 5 - nearest receptor	R9	18.6	18.6
Kiina closest receptor	R10	20.9	20.9	Kiina	south	Kiina closest receptor	R10	16.6	16.6
Ikamiro Village	R8/NMP11	24.3	23.4	Ikamiro	Pad 1	Ikamiro Village	R8/NMP11	15.2	14.5
Wellpad 2						Wellpad 2			
Name	ID	Level Lr Day (dBA)	Night (dBA)	Identified Receptor village	area	Name	ID	Level Lr Day (dBA)	Night (dBA)
Pad 4_2 - nearest receptor	R1	32.1	32.1	Kyakapere	north	Pad 4_2 - nearest receptor	R1	25.8	25.8
Pad2 - nearest receptor	R2	58.4	58.4	Kyakapere	south	Pad2 - nearest receptor	R2	46.2	46.2
Kyabasambu - nearest receptor	R3	58.0	58.0	Kyabasambu	north	Kyabasambu - nearest receptor	R3	44.4	44.4
Wellpad1 - nearest receptor	R4	43.4	43.4	Kyabasambu	south	Wellpad1 - nearest receptor	R4	34.6	34.6
Nsonga North	R5	35.7	35.7	Nsonga	north	Nsonga North	R5	28.5	28.5
Nsonga South	R6	27.4	27.4	Nsonga	south	Nsonga South	R6	23.0	23.0
Pad 3 nearest receptor - Nsunzu north	R7	25.7	25.7	Nsunzu	north	Pad 3 nearest receptor - Nsunzu north	R7	20.8	20.8
Pad 5 - nearest receptor	R9	16.7	16.7	Kiina	north	Pad 5 - nearest receptor	R9	11.1	11.1
Kiina closest receptor	R10	15.5	15.5	Kiina	south	Kiina closest receptor	R10	11.0	11.0
Ikamiro Village	R8/NMP10	23.7	22.8	Ikamiro	-	Ikamiro Village	R8/NMP10	11.8	11.5
Wellpad 3						Wellpad 3			
Name	ID	Level Lr Day (dBA)	Night (dBA)	Identified Receptor village	area	Name	ID	Level Lr Day (dBA)	Night (dBA)
Pad 4_2 - nearest receptor	R1	16.3	16.3	Kyakapere	north	Pad 4_2 - nearest receptor	R1	10.9	10.9
Pad2 - nearest receptor	R2	27.3	27.3	Kyakapere	south	Pad2 - nearest receptor	R2	24.4	24.4
Kyabasambu - nearest receptor	R3	30.5	30.5	Kyabasambu	north	Kyabasambu - nearest receptor	R3	28.3	28.3
Wellpad1 - nearest receptor	R4	34.4	34.4	Kyabasambu	south	Wellpad1 - nearest receptor	R4	29.7	29.7
Nsonga North	R5	40.7	40.7	Nsonga	north	Nsonga North	R5	33.5	33.5
Nsonga South	R6	67.9	67.9	Nsonga	south	Nsonga South	R6	55.1	55.1
Pad 3 nearest receptor - Nsunzu north	R7	57.5	57.5	Nsunzu	north	Pad 3 nearest receptor - Nsunzu north	R7	46.7	46.7
Pad 5 - nearest receptor	R9	37.1	37.1	Kiina	north	Pad 5 - nearest receptor	R9	32.8	32.8
Kiina closest receptor	R10	34.7	34.7	Kiina	south	Kiina closest receptor	R10	28.3	28.3
Ikamiro Village	R8/NMP10	22.9	22.0	Ikamiro	-	Ikamiro Village	R8/NMP10	13	12.5
Wellpad 4-2						Wellpad 4-2			
Name	ID	Level Lr Day (dBA)	Night (dBA)	Identified Receptor village	area	Name	ID	Level Lr Day (dBA)	Night (dBA)
Pad 4_2 - nearest receptor	R1	80.8	80.8	Kyakapere	north	Pad 4_2 - nearest receptor	R1	70.0	70.0
Pad2 - nearest receptor	R2	36.5	36.5	Kyakapere	south	Pad2 - nearest receptor	R2	27.0	27.0
Kyabasambu - nearest receptor	R3	33.9	33.9	Kyabasambu	north	Kyabasambu - nearest receptor	R3	27.6	27.6
Wellpad1 - nearest receptor	R4	30.5	30.5	Kyabasambu	south	Wellpad1 - nearest receptor	R4	25.6	25.6
Nsonga North	R5	25.4	25.4	Nsonga	north	Nsonga North	R5	19.0	19.0
Nsonga South	R6	17.1	17.1	Nsonga	south	Nsonga South	R6	12.1	12.1
Pad 3 nearest receptor - Nsunzu north	R7	17.5	17.5	Nsunzu	north	Pad 3 nearest receptor - Nsunzu north	R7	10.5	10.5
Pad 5 - nearest receptor	R9	5.7	5.7	Kiina	north	Pad 5 - nearest receptor	R9	4.5	4.5
Kiina closest receptor	R10	7.3	7.3	Kiina	south	Kiina closest receptor	R10	2.6	2.6
Ikamiro Village	R8/NMP10	14.7	14.7	Ikamiro	-	Ikamiro Village	R8/NMP10	9.6	9.5
Wellpad 5						Wellpad 5			
Name	ID	Level Lr Day (dBA)	Night (dBA)	Identified Receptor village	area	Name	ID	Level Lr Day (dBA)	Night (dBA)
Pad 4_2 - nearest receptor	R1	8.2	8.2	Kyakapere	north	Pad 4_2 - nearest receptor	R1	6.3	6.3
Pad2 - nearest receptor	R2	23.0	23.0	Kyakapere	south	Pad2 - nearest receptor	R2	22.4	22.4
Nsunzu nearest receptor	R3	27.0	27.0	Kyabasambu	north	Kyabasambu - nearest receptor	R3	26.6	26.6
Wellpad1 - nearest receptor	R4	27.5	27.5	Kyabasambu	south	Wellpad1 - nearest receptor	R4	25.8	25.8
Nsonga North	R5	26.8	26.8	Nsonga	north	Nsonga North	R5	23.6	23.6
Nsonga South	R6	36.9	36.9	Nsonga	south	Nsonga South	R6	32.2	32.2
Pad 3 nearest receptor - Nsunzu north	R7	40.9	40.9	Nsunzu	north	Pad 3 nearest receptor - Nsunzu north	R7	35.6	35.6
Pad 5 - nearest receptor	R9	79.5	79.5	Kiina	north	Pad 5 - nearest receptor	R9	62.9	62.9
Kiina closest receptor	R10	47.5	47.5	Kiina	south	Kiina closest receptor	R10	39	39
Ikamiro Village	R8/NMP10	18.6	18.6	Ikamiro	-	Ikamiro Village	R8/NMP10	11.6	11.2



May 2018

REPORT – VOLUME 4, STUDY 7



CNOOC UGANDA LIMITED

Visual Impact Assessment Report for the Proposed Kingfisher Development

Submitted to:

The Executive Director National Environment Management Authority, NEMA House,
Plot 17/19/21 Jinja Road, P. O. Box 22255 Kampala, Uganda

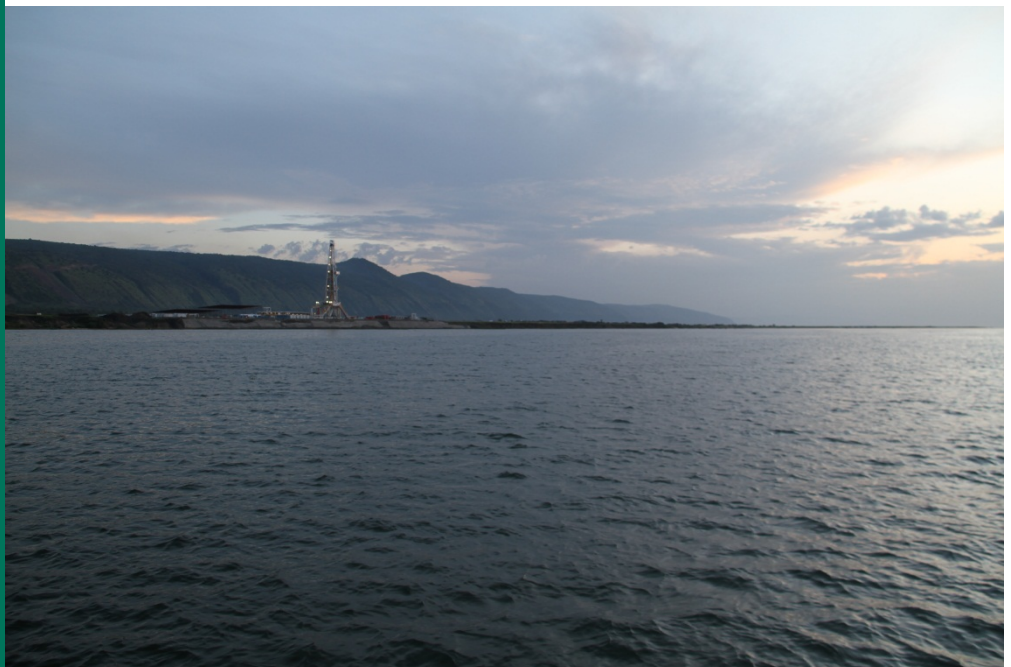

Report Number: 1776816-321515-16

Distribution:

- 1 x electronic copy CNOOC Uganda Limited
- 1 x electronic copy NEMA
- 1 x electronic copy Eco & Partner
- 1 x electronic copy Golder





List of Acronyms

Acronym	Explanation
CNOOC	China National Offshore Oil Corporation
CPF	Central Processing Facility
DRC	Democratic Republic of the Congo
ESIA	Environmental and Social Impact Assessment
VAC	Visual Absorption Capacity
VIA	Visual Impact Assessment



Table of Contents

1.0 INTRODUCTION	1
2.0 TERMS OF REFERENCE	1
3.0 PROJECT SUMMARY	2
3.1 CPF, wells flowlines and associated infrastructure	2
3.2 Feeder pipeline	2
4.0 VISUAL BASELINE ASSESSMENT METHODOLOGY	5
4.1 Assessment methodology	5
4.2 Assumptions and qualifications	6
5.0 CPF, WELLS AND ASSOCIATED INFRASTRUCTURE	8
5.1 Study area	8
5.2 Baseline visual resource assessment	8
5.2.1 Landscape visual character	8
5.2.1.1 Topography	9
5.2.1.2 Water bodies	10
5.2.1.3 Vegetation cover	12
5.2.1.4 Visual absorption capacity	13
5.2.1.5 Sense of place	14
5.2.2 Visual resource value assessment	17
5.3 Visual impact assessment	18
5.3.1 Project phases and potential visual impacts	18
5.3.2 Visual impact criteria	20
5.3.2.1 Level of visibility	20
5.3.2.2 Visual exposure	20
5.3.2.2.1 Receptor-based viewsheds	21
5.3.2.2.2 Impactor-based viewsheds	21
5.3.2.3 Visual intrusion	31
5.3.3 Impact intensity	36
5.3.4 Impact magnitude	36
5.3.4.1 Direction	37
5.3.4.2 Geographic extent	37





5.3.4.3	Duration	37
5.3.4.4	Reversibility	37
5.3.5	Impact significance.....	39
5.3.5.1	Visual receptor sensitivity	39
5.3.5.2	Impact significance assessment	40
5.3.6	Visual impact mitigation	41
5.3.6.1	Temporary impacts.....	41
5.3.6.1.1	Dust pollution	41
5.3.6.1.2	Increased construction equipment/plant, vehicles, and materials handling activities .	41
5.3.6.2	Daytime impacts - visually intrusive project elements.....	41
5.3.6.2.1	Vegetation screens.....	41
5.3.6.2.2	Architectural and landscaping measures.....	42
5.3.6.3	Night-time light pollution	48
5.3.6.4	Loss of sense of place	48
6.0	PIPELINE CORRIDOR	56
6.1	Study area	56
6.2	Baseline visual resource value assessment	56
6.2.1	Landscape visual character	56
6.2.2	Visual resource value assessment.....	57
6.3	Visual impact assessment	57
6.3.2	Project phases and potential visual impacts	58
6.3.3	Visual impact criteria.....	58
6.3.3.1	Visibility.....	58
6.3.3.2	Visual exposure	58
6.3.3.3	Visual intrusion	58
6.3.4	Impact intensity	59
6.3.5	Impact magnitude	59
6.3.6	Impact significance.....	60
6.3.6.1	Visual receptor sensitivity	60
6.3.6.2	Impact significance assessment	60
6.3.7	Visual impact mitigation	61
7.0	CONCLUSION	63
8.0	RECOMMENDATIONS AND WAY FORWARD	63





9.0 REFERENCES..... 65

TABLES

Table 1: Production facility study area visual resource summary.....	18
Table 3: Anticipated visual impacts associated with the various project phases	19
Table 4: Level of visibility rating	20
Table 5: Level of visual exposure.....	21
Table 6: Visual impact criteria rating	36
Table 7: Visual impact intensity.....	36
Table 8: Visual impact magnitude	38
Table 9: Magnitude assessment criteria and rating scale	38
Table 10: Visual receptor sensitivity.....	39
Table 11: Determination of impact significance.....	40
Table 12: Summary of pre- and post-mitigation impact significance	55
Table 13: Pipeline corridor study area visual resource summary.....	57
Table 14: Visual impact criteria rating	59
Table 15: Visual impact intensity.....	59
Table 16: Visual impact magnitude	60
Table 17: Visual receptor sensitivity.....	60
Table 18: Determination of impact significance.....	61
Table 19: Summary of pre- and post-mitigation impact significance	62

FIGURES

Figure 1: Project infrastructure to be developed on the Buhuka Flats.....	3
Figure 2: Project site location and feeder pipeline route	4
Figure 3: Visual impact assessment methodology	6
Figure 4: Topographical character of the main project study area	10
Figure 6: Vegetation cover attributes of the production site study area.....	13
Figure 7: The study area is characterised by low levels of visual absorption capacity	15
Figure 8: Land use within the main project study area	16
Figure 9: Atmospheric conditions can greatly influence the visual appearance of the landscape and contribute to visual appeal and sense of place	17
Figure 10: Visual impact vs. visual exposure distance	20
Figure 11: Visibility of project infrastructure from Kyakapere village (receptor-based viewshed).....	23
Figure 12: Visibility of project infrastructure from Kyabasambu village (receptor-based viewshed)	24
Figure 13: Visibility of project infrastructure from Nsonga village north (receptor-based viewshed).....	25
Figure 14: Visibility of project infrastructure from Nsonga village south (receptor-based viewshed)	26





VISUAL IMPACT ASSESSMENT REPORT

Figure 15: Night-time illumination within study area for CPF and drill rig at well pad 4 (impactor-based viewshed)	27
Figure 16: Night-time illumination within study area for CPF and drill rig at well pad 2 (impactor-based viewshed)	28
Figure 17: Night-time illumination within study area for CPF and drill rig at well pad 1 (impactor-based viewshed)	29
Figure 18: Night-time illumination within study area for CPF and drill rig at well pad 3 (impactor-based viewshed)	30
Figure 19: The well pad drill rig is the most visually intrusive element of the project.....	31
Figure 20: Daytime view of the CPF site from the northwest, after construction of the project infrastructure.....	32
Figure 21: Night-time view of the CPF site from the northwest, before (top) and after (bottom) construction of the project infrastructure.....	33
Figure 22: Night-time view of the permanent camp, CPF site and well pads 1 and 2 positions, before (top) and after (bottom) construction of the project infrastructure	34
Note: in the “after” (bottom) image, the drill rig has been moved from well pad 2 further north to well pad 1, located approximately 500 m from the viewer.....	34
Figure 23: Night-time panoramic view of the peninsula and production site from the southeast along the escarpment, before (top) and after (bottom) construction of the project infrastructure	35
Figure 24: Visibility of project infrastructure from Kyakapere village (receptor-based viewshed) after visual screening.....	43
Figure 25: Visibility of project infrastructure from Kyabasambu village (receptor-based viewshed) after screening	44
Figure 26: Visibility of project infrastructure from Nsonga village north (receptor-based viewshed) after screening	45
Figure 27: Visibility of project infrastructure from Nsonga village south (receptor-based viewshed) after screening	46
Figure 28: Daytime view of the CPF site from the northwest, before (top) and after (bottom) visual mitigation	47
Figure 29: Night-time illumination (impactor-based viewshed) within study area for CPF and drill rig at well pad 4, after screening.....	49
Figure 30: Night-time illumination (impactor-based viewshed) within study area for CPF and drill rig at well pad 2, after screening.....	50
Figure 31: Night-time illumination (impactor-based viewshed) within study area for CPF and drill rig at well pad 1, after screening.....	51
Figure 32: Night-time illumination (impactor-based viewshed) within study area for CPF and drill rig at well pad 3, after screening.....	52
Figure 33: Night-time view of the permanent camp, CPF site and drill rig at well pads 1, before (top) and after (bottom) implementation of screening	53
Figure 34: Night-time view of the CPF site from the northwest, before (top) and after (bottom) implementation of screening.....	54
Figure 35: Typical construction related activities and visual impacts associated with the construction phase of a large pipeline project (images Wikipedia, 2017; CCPipeline, 2017)	58
Figure 36: Rehabilitation of a backfilled pipeline corridor	62





1.0 INTRODUCTION

CNOOC Uganda Limited (“CNOOC”) is developing the Kingfisher field Development on the eastern shore of Lake Albert, in the Hoima District of Uganda. In accordance with Ugandan law, it is necessary for CNOOC to determine the potential environmental and social impacts of the project and to demonstrate how these will be mitigated and managed. Golder Associates (Golder) was appointed to conduct the required Environmental and Social Impact Assessment (ESIA) for the proposed CNOOC Kingfisher project for this purpose. This report presents the aesthetics baseline and visual impact assessment (“VIA”) for the proposed project.

This VIA report separately assesses the main components of the project, namely:

- Production facility, which will be located on the Buhuka Flats along the eastern escarpment of Lake Albert. The facility will consist of the central processing facility (CPF) and four well pads which will be drilled consecutively, as well as a permanent worker camp and other supporting infrastructure; and
- Feeder pipeline, which will connect the production facility with a proposed refinery to be located at Kabaale, 46.2 km to the north east.

This report is structured in the following main sections:

Section 1 – Project context:

- Introduction;
- Terms of reference;
- Project summary;
- Visual baseline assessment methodology; and
- Assumptions and limitations

Section 2 – Main production facility:

- Study area;
- Baseline visual resource value assessment; and
- Visual impact assessment.

Section 3 – Pipeline corridor:

- Study area;
- Baseline visual resource value assessment; and
- Visual impact assessment.

Section 4 – Conclusion:

- Summary;
- Recommendations and way forward; and
- References.

2.0 TERMS OF REFERENCE

The terms of reference for this VIA are listed below:

- Assess the baseline conditions and perceived aesthetic resource value of the visual context within which the CNOOC project will be located;
- Establish what visual impacts may potentially arise as a result of the project, should it proceed;



- Determine what visual receptor groups may potentially be affected by the project, and the likely perceived significance of the visual impacts caused; and;
- Investigate possible methods by which the potential impacts may be mitigated or reversed, where feasible.

3.0 PROJECT SUMMARY

3.1 CPF, wells flowlines and associated infrastructure

Wells, The Kingfisher development is an upstream project comprising wells, flow lines, central processing facility (CPF) and associated infrastructure and an oil product line, the feeder pipeline, to distribute oil to the tie in point with the export pipeline at Kabaale. This infrastructure is summarised in more detail below.

The wells, flowlines, central processing facility (CPF) and supporting infrastructure are situated on the Buhuka Flats in the Kingfisher Development Area (KFDA), on the south-eastern shores of Lake Albert. The project entails the drilling of wells from four onshore well pads, namely Pad 1, Pad 2, and Pad 3 (where exploration wells have already been drilled) together with Pad 4A (where no drilling has yet taken place). A total of 31 wells are planned to be drilled and commissioned as part of the development, 20 of which will be production wells and 11 to be used as water reinjection wells.

The produced well fluids will be conveyed to the CPF through buried infield flow lines connecting each well pad to the CPF. Well fluids will be separated at the CPF to yield produced water, sand, salts and associated gas (together with small quantities of other material) and crude oil of a quality that will meet the crude oil export standard. At the CPF the associated gas will be utilised for production of power or LPG for local market. Power will serve the requirements of the Kingfisher development but in later years is likely to be in excess of project requirements and will be exported to the national grid. No gas flaring is contemplated except in cases of emergency.

Supporting infrastructure associated with the production facility will include in-field access roads and flowlines, a jetty, and a water abstraction station on Lake Albert, a permanent camp, a material yard (or 'supply base'), and a safety check station at the top of the escarpment. (Figure 1).

3.2 Feeder pipeline

A feeder pipeline exits from the CPF and extends to the north running from the CPF storage tanks to a delivery point near Kabaale. The feeder pipeline exits the CPF on the east side, running almost due north to the base of the escarpment, where the alignment turns to the East climbing the escarpment. The average gradient in this section of the route is 1:3 (Vertical: Horizontal), rising from roughly 650 to 1040 mamsl. within a horizontal distance of 740 m. From the point at which the feeder pipeline crests the escarpment, the pipeline route runs to the north-east through gently undulating terrain that is extensively cultivated. This landscape includes a number of rural settlements. The route passes south-east of Hohwa and Kaseeta villages and passes immediately north of the planned Kabaale Airport, turning eastward to the terminal point at the proposed Kabaale Refinery. The total length of the pipeline is 46.2 km.

At Kabaale, the Government of Uganda is planning an industrial park which, among other facilities, will include a refinery, associated petrochemical processing plants, an international airport and related supporting infrastructure.

At the delivery point, there will be metering of the crude oil, which will be piped either to the industrial park to feed the refinery and associated petrochemical industry or exported through the East African Crude Oil Pipeline (EACOP), planned from Kabaale to the Tanga sea port in Tanzania. The EACOP will be a public - private partnership between the governments of Uganda, Tanzania and oil company(s).

The Feeder Pipeline ends at the delivery point in Kabaale. The industrial park and the EACOP are independent projects that do not feature further in the FD-ESMP (Figure 2).

.



Figure 1: Project infrastructure to be developed on the Buhuka Flats





VISUAL IMPACT ASSESSMENT REPORT

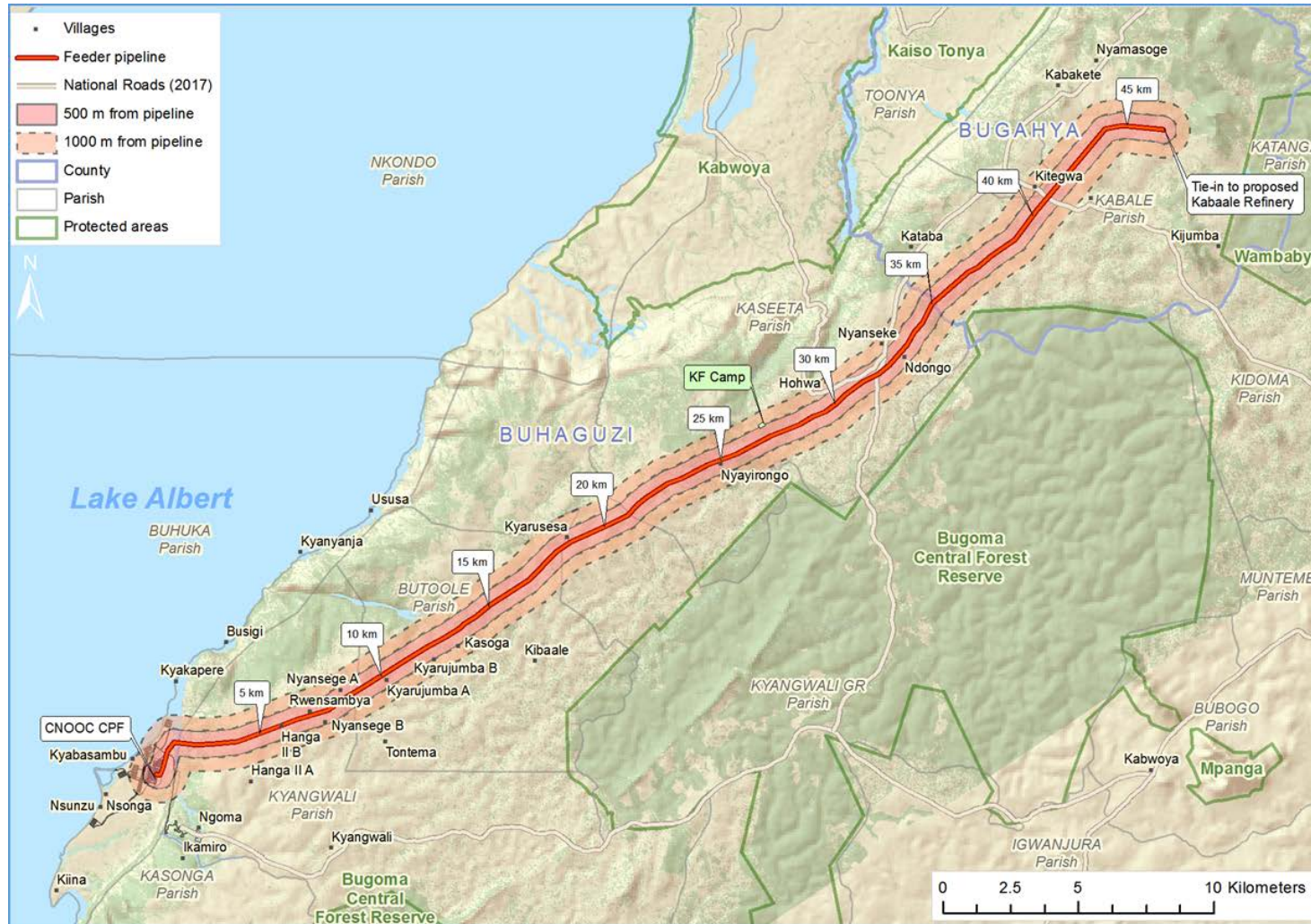

Figure 2: Project site location and feeder pipeline route





4.0 VISUAL BASELINE ASSESSMENT METHODOLOGY

4.1 Assessment methodology

- This VIA specialist study was conducted following a series of consecutive steps discussed below and illustrated by Figure 3:
- **Step one:** determining the intensity of the impact, which is a function of the visual resource value of the study area and a number of industry-standard visual assessment criteria, i.e. visibility, visual intrusion and visual exposure. This was done as follows:
 - Describing the baseline landscape visual character of the project study area based on the findings of the scoping phase site visit conducted on the 3rd and 4th of December 2014, as well as a review of available aerial photography and topographical maps, in terms of:
 - Overall topographical character and specific landform features;
 - Water bodies and features as well as drainage lines and patterns;
 - Overall vegetation cover and specific vegetation communities;
 - Visual absorption capacity of the landscape; and
 - Sense of place of the landscape, as a function of the relationship between the afore-mentioned aspects and human activity in the study area.
 - Determining the visual resource value of the landscape, based on the above visual characteristics;
 - Conducting an assessment of the likely visual impacts of the project, using recognised visual assessment criteria namely:
 - Theoretical visibility;
 - Visual intrusion; and
 - Visual exposure.
 - Determining the impact intensity, by considering the results of the above visual impact assessment in terms of the landscape visual resource value;
- **Step two:** evaluating the impact magnitude, in terms of the following standard impact assessment criteria:
 - Direction of the impact (whether the impact is positive or negative);
 - Geographic extent of the impact (over how large an area will the impact likely be experienced by receptors, which in the context of visual assessment comprises different people groups);
 - Duration of the impact (how long will it last for); and
 - Reversibility (whether there will be any lasting effect on receptors once the sources of visual impact is removed).
- **Step three:** determining the perceived significance of the visual impact, by assessing the degree of sensitivity of the receptors together with the magnitude of the impact caused; and
- **Step four:** Identifying potential mitigation measures to reduce or the magnitude of the visual impacts, where feasible.

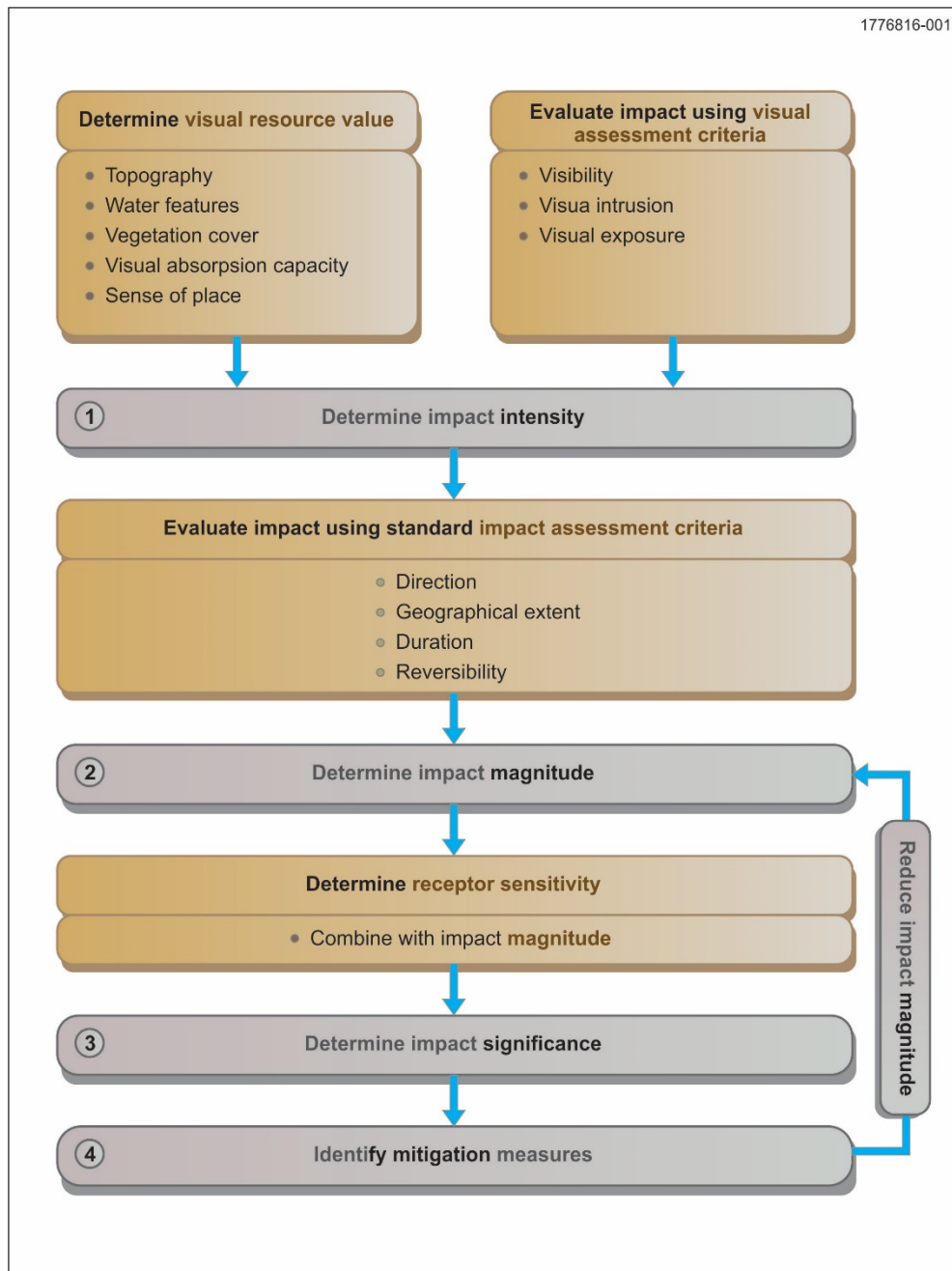

Figure 3: Visual impact assessment methodology

4.2 Assumptions and qualifications

The following assumptions and qualifications are relevant to the process followed, as well as findings of this VIA:

- Determining the value, quality and significance of a visual resource, or the significance of the impact that an activity may have on it, in absolute terms, is not achievable. The value of a visual resource is partly determined by the receptor or viewer, and therefore influenced by a person’s personal preferences as well as fluctuating factors such as emotional mood. Changes in conditions such as weather patterns, time of day and the season during which the landscape is viewed can also dramatically alter its appearance, and perceived resultant appeal;





- It is furthermore acknowledged that different cultures attach diverse values to the landscape, and that different aesthetic considerations may therefore also apply to different people groups. Individual or constituent elements of the landscape may be of specific importance to certain people groups, which may not be obvious to others;
- For these reasons, visual impact cannot be measured by empirical standards only, as is for instance the case with water, noise or air pollution. It is therefore impossible to conduct a visual assessment without also relying on the expert professional opinion of a qualified consultant, who is by nature biased and therefore to some extent subjective. However, a large body of scientific knowledge exists on the field of visual assessment, which were applied in conducting this study. The opinion of the visual consultant is unlikely to materially influence the findings and recommendations of the study, and is therefore not expected to marginalise specific socio-cultural or religious value systems;
- This VIA assessed the visual resource value of the study area as a single entity, even though discreet attributes of the landscape character were considered. This was done because of the very strong “sense of place” that this particular landscape possesses, which is as much a function of the relationship between the various landscape character elements, as it is of the individual constituent attributes themselves. This is an important point, as the implication is that changes to any one landscape character attribute will have an impact on the entire visual study area. Visual impacts in such a context can therefore not easily be “isolated”, in order to mitigate them;
- The potential visual impacts of the proposed project has been assessed from an anthropocentric point of view only, as evaluating the potential impact on other biota was not part of the scope of work for this VIA. However, it is expected that the ecological impact of specifically light pollution at night will be significant, as aquatic animals in Lake Albert as well as insects that use moonlight for navigation will be negatively impacted by the development;
- The viewshed analysis was conducted using the latest available project development layout plans, as well as heights for the various project components as provided by the client. However three-dimensional models for the various infrastructure components were not available, and were therefore conceptually generated by Golder for graphic representations purposes;
- The following CPF infrastructure heights as provided by client were used when generating the various viewshed analyses and graphic representations:
 - Flare stack – 28 m;
 - Production treatment towers – 20 m;
 - Oil tank storage – 18 and 15 m respectively;
 - Respective other buildings and structures ranging from 8 m to 15 m in height; and
 - The existing drill rig, of which the height was estimated at approximately 60 m, using photos taken during the site visit.
- Certain photographs have been digitally “stitched” together or alternatively cropped to illustrate certain concepts, and may not represent a “natural” view or perspective as viewed by the human eye;
- The findings of this report are considered to be indicative of the nature and magnitude of the potential project visual impacts only, due to the preliminary nature of the available layout and design drawings. Certain findings of this VIA including proposed mitigation measures may therefore need to be reviewed and updated, when final site layout drawings have been produced and/or actual project implementation commences; and
- The quality of especially the night-time photos and graphic simulations are significantly reduced when printed, or during low-resolution conversion of the original MS Office Word file to .pdf or other formats. It is therefore recommended that the report be viewed in its original Word format, or that the photos and graphic simulations be printed at a high resolution on photo quality paper.



5.0 CPF, WELLS AND ASSOCIATED INFRASTRUCTURE

5.1 Study area

The proposed development has the potential result in visual impact through introduction of project infrastructure in largely undeveloped areas, causing the existing landscape to be altered. In addition. For the purposes of this VIA, the project study area is therefore defined as the spatial footprint of the infrastructure and related landscape alterations, as well as an associated zone of influence from which these elements and changes may be visible. Two project study areas were identified, namely that of the main production facility area which is described below, and that of the feeder pipeline which is described in Section 3 of the report.

The minimum study area for the production plant area was defined as a 10 km radius around the physical footprint of the Kingfisher production site infrastructure illustrated on Figure 1. The distance of 10 km was selected based on the assumption that most daytime visual impacts regardless of their nature or extent, will be relatively inconspicuous beyond this range as the human eye can no longer distinguish significant detail over this distance. Exceptions in this regard are only where very large structures such as power stations or large wind turbines, are erected in rural or undeveloped areas. Furthermore, visual impacts may also extend well beyond this distance in certain landscapes, such as in very flat areas or where viewed from elevated locations.

Light pollution is particularly significant at night and can extend over significant distances, as most of the visual detail that may camouflage a visual impact by day is not present/visible at night. A cursory overview of various online sources dealing with astronomy and star gazing indicate that relatively small towns may cause light pollution beyond a range of 20 miles / 30 km. The visual impact is caused both as a result of direct glare and indirect sky glow caused by the lights. Given the fact that there are almost no bright lights within the existing study area aside from the existing project pilot infrastructure, it is expected that the CPF and well rig will likely be visible from the opposite (western) shore of Lake Albert, in the Democratic Republic of the Congo (DRC).

5.2 Baseline visual resource assessment

5.2.1 Landscape visual character

It is necessary to first determine the visual resource value of a landscape, in order to assess what the actual perceived visual impact of a proposed project on that landscape may be. Visual resource value refers to the perceived aesthetic quality of individual aspects of an environment, as well as the relationships between these elements and how they appeal to our senses. The visual resource value of the landscape is therefore assessed by considering both the natural (physical and biological) and human-made (land use) attributes within a given study area.

Studies in perceptual psychology have shown that in a broad sense, humans have an affinity for landscapes with a higher visual complexity, than for homogeneous ones (NLA, 2004). Furthermore, based on research in human visual preference (Crawford, 1994), landscape visual quality is a function of the following landscape attributes, which were assigned score values for the purposes of this VIA:

- The general topographical character of the study area including prominent landforms, and the spatial orientation of these in terms of the project site. Landscapes with prominent and varied topography and/or interesting geological landmarks and features are considered to have high visual resource value (rated 3), whereas landscapes with rolling and relatively featureless topography have lower visual resource values (rated 1 to 2, depending on the context);
- The nature, physical extent and appearance of water bodies such as lakes, dams, rivers, pans or wetlands within the study area. Large expanses of open water, prominent watercourses or interesting features such as waterfalls typically have a high visual resource value (rated 3), whereas less prominent hydrological features such as wetlands, ephemeral pans or smaller streams have a moderate visual resource value (rated 2). In landscapes where few to no hydrological features are present, this aspect is rated as low (1);



- The nature of the vegetation cover within the study area in terms of its density, height, visual diversity and level of disturbance. Landscapes characterised by prominent natural vegetation with relatively high levels of visual diversity such as forests, woodlands and expansive blooming fields are rated as having high visual resource value (3). Vegetation cover that is not particularly prominent or visually diverse such as grasslands, artificial woodlots or croplands are rated as moderate (2). In landscapes where the natural vegetation cover has been largely displaced by invaders or removed, this aspect is rated as being of low visual resource value (1). It is however important to realise that context also plays a significant and somewhat subjective role in this regard, as a lack of vegetation cover can in some instances still result in visually appealing conditions, such as desert landscapes;
- The level of visual absorption capacity (VAC) of the existing landscape, which is the ability of the landscape to accommodate alterations without a significant negative impact or reduction in the visual resource value of the landscape. Landscapes that are characterised by very low VAC are rated as sensitive or high (3) in this regard, as they will be most severely impacted by any new development. Landscapes that will likely be only moderately impacted due to some pre-existing development and/or visual complexity, are rated as moderate (2). Conversely, landscapes that are unlikely to be materially impacted by new or further development are rated as low (1); and
- The perceived sense of place of the landscape, or the degree of visual uniqueness or distinctiveness of the landscape and the cultural and spiritual significance that different people groups attach to it. Landscapes that have a very strongly defined visual character, or with high levels of cultural or spiritual significance attached to them by certain population groups, are rated as high (3). Similarly, national or international landmarks are also considered as having a strongly defined sense of place, as they are usually unique and highly recognisable, and therefore irreplaceable. Conversely, landscapes in which the pre-existing natural attributes have been largely displaced by visually incoherent and intrusive elements and that are not associated with any specific group of people would be considered to have little, or alternatively a negative sense of place, and would be rated low (1). This aspect is obviously subject to a significant degree of personal interpretation and may be highly context-specific, as significantly transformed or built-up landscapes may still have a strongly defined positive sense of place, as would for instance be the case with cultural-historic monuments, or highly scenic towns and cities.

When assessing the value of a landscape as a visual resource, it is also necessary to consider the landscape in terms of the broader context in which it is located. Although a specific landscape may objectively be considered to be less scenically appealing than other similar but far-off landscapes, it may still be considered significant in terms of the local visual context within which it is located. In this way, what may be commonplace when placed in another visual context, may be special or exceptional when viewed within its present setting.

The baseline assessment and resultant resource determination was conducted based on a dedicated photographic assessment of the study area carried out by the Golder VIA specialist on 3 and 4 December 2014, as well as using photographs that were taken by other specialists during 2014. Available Google Earth satellite imagery from 2013 and 2016 as well as recent high-resolution aerial imagery dated were also used as reference. The existing visual baseline is summarised in terms of the individual attributes listed above, followed by an assessment of the resultant visual resource value.

5.2.1.1 Topography

The main production facility area is characterised by two distinct topographical zones, namely:

- The high escarpment which encircles most of Lake Albert, which is vertically prominent; and
- The narrow peninsula on which the production facility site is located and the adjacent Lake Albert, which are both horizontally dominant.

The stark juxtaposition between the prominent, linear relief of the escarpment and the vast, near-flat surface formed by the peninsula and adjacent water body is largely responsible for the strongly unique visual character of the study area. The visual contrast and sense of enclosure is also emphasised by the encircling



escarpment mountains on the other side of Lake Albert in the DRC, which are visible from the site under clear conditions.

These unique attributes together form one inseparable visual context, with the result that altering either landscape attribute fundamentally impacts on the visual landscape as a whole. This effect is illustrated by the third photograph in Figure 4 below, which shows the profound impact of the access road excavations and single drilling rig on the visual landscape as a whole.



Vertically dominant escarpment cliffs and hills encircling Lake Albert



Horizontally dominant peninsula on which the main project site is located



The strong juxtaposition between the linear escarpment mountains and flat peninsula forms the most prominent visual attribute of the study area

Figure 4: Topographical character of the main project study area

Based on the above summary, the contribution of the study area topography in terms of its overall visual resource value is rated as **high (3)**.

5.2.1.2 Water bodies

Lake Albert constitutes the entire eastern half of the project study area, whilst the visual range of the western half of the study area is largely truncated by the high escarpment. For this reason, the lake is considered the single-most prominent visual element in terms of this VIA. In addition to being responsible for what would universally be considered as beautiful scenery, the lake is also central to the regional biological diversity and forms an integral component of the livelihoods of the local villagers. Lake Albert as one of the East African Rift Valley lakes is also bisected by the national border between Uganda and the DRC; and as such is an internationally recognised landmark.

Aside from Lake Albert itself, a small reed-lined estuary pool is located on the lake's edge in the northern part of the peninsula, and a shallow watercourse fringed by wetlands bisects the southern half of the peninsula. However, these features are only prominent when viewed from elevated vantage points or from close up. Furthermore, the escarpment face is deeply grooved by many non-perineal drainage lines characterised by denser vegetation cover, and that only convey runoff after rainfall events.

These aspects are illustrated by Figure 5 below.

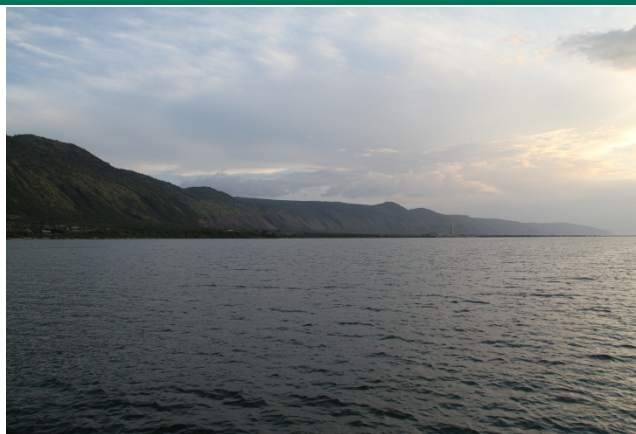

Lake Albert constitutes the entire eastern half of the project study area



The lake is central to the visual character of the study area and responsible for highly appealing scenery



The lake is a determining factor in terms of regional biodiversity



The majority of the local residents are dependent on the lake for their livelihood



Small reed-lined estuary pool located on the lake's edge in the northern part of the peninsula



Grooved escarpment face, with non-perineal drainage lines characterised by denser vegetation cover

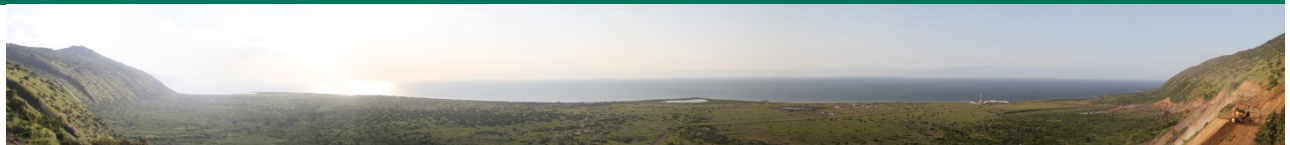

Lake Albert is an internationally recognised landmark, and has a strongly identifiable visual character and sense of visual appeal

Figure 5: Hydrological characteristics of the main project study area



Based on the above summary, the contribution of water bodies and specifically Lake Albert to the visual resource value of the overall project study area, is rated as **high (3)**.

5.2.1.3 *Vegetation cover*

The region is characterised by a variety of vegetation types, however the majority of the narrow peninsula is dominated by low grasses and scrubland, allowing for uninterrupted long range views. The result is that the attention of viewers is rather focussed on the various other visual attributes of the study area. The escarpment and plateau are typically characterised by more dense vegetation with a far greater percentage of shrubs and small trees, especially within the drainage lines. However, this vegetation is not considered to be a dominant visual aspect of the study area itself, as it effectively becomes the colour and texture of the far more prominent escarpment. The visual appeal of the vegetation therefore lies mostly in the detail of individual plants or groups, rather than as a distinct characteristic attribute of the study area.

In this regard, the escarpment access road excavations and earthworks are considered to be highly intrusive, due to the contrasting spoil rock heaps and its strongly diagonal alignment across the face of the escarpment. On a local scale, the natural vegetation cover is also being threatened by the presence of a number of invasive alien plant species. These infestations are more common in the vicinity of the various villages, as well as areas where prolonged grazing takes place. In these areas, the otherwise visually coherent appearance of the natural vegetation cover has been clearly disrupted by the intruding plant species.

The vegetation cover of the main study area is illustrated by Figure 6 below.

Although the local flora contributes to the overall scenic quality of the area, the vegetation cover is not visually dominant and much of the appeal therefore rather lies in specific details. Based on the above summary, the contribution of the vegetation cover to the visual resource value of the overall project study area is rated as **moderate (2)**.



The dominant grassland conditions found on the peninsula generally allow for long range views



Invasive alien plant species threaten the visual character of the study area, especially near the villages



The appeal of the local flora mainly lies in detail aspects, rather than as a distinct visual attribute of the study area



The loss of vegetation cover, as well as contrasting colours and textures of the access road excavations along the escarpment is visually intrusive

Figure 6: Vegetation cover attributes of the production site study area

5.2.1.4 Visual absorption capacity

The perceived significance of a visual impact is at least partly dependent on the degree to which the existing landscape can accommodate alterations, without resulting in a significant alteration in the overall visual appearance and character of the landscape. This aspect is referred to as its visual absorption capacity



(VAC), and can be defined as an “*estimation of the capacity of the landscape to absorb development without creating a significant change in visual character or producing a reduction in scenic quality*” (Oberholzer, 2005).

The ability of a landscape to absorb development or additional human intervention is therefore primarily a function of the topography, dominant vegetation cover, and nature and prevalence of pre-existing human structures in that landscape. A further major factor is the degree of visual contrast between a proposed new project, and that of the existing elements in the landscape. If, for example, a visually prominent industrial complex already exists in an area, the capacity of that landscape to visually “absorb” additional industrial development is higher than that of a landscape dominated for instance by low density rural development.

The northern, southern and especially western quadrants of the study area are characterised by very long range views, as a result of the lack of prominent screening topography, tall and dense vegetation or existing development. The notable exception in this regard is the tall escarpment, which significantly truncates the range of views to the east. The overall colour palette of the landscape is relatively narrow if highly diversified, ranging from various greens, tans and ochres to darker browns and greys. Especially the surface of the lake forms a very uniform visual backdrop, ranging from greyish to greenish blues and other hues, depending on the time of day and atmospheric conditions. These visual attributes all result in a landscape that has a low overall VAC, as any horizontally expansive, tall or more brightly coloured infrastructure will be very prominent and therefore visually intrusive.

The night-time landscape is characterised by a lack of almost any artificial illumination, save for small pinpricks of lights associated with the villages and those of isolated telecommunications towers situated on the highest hills on the escarpment. The frequent cloud cover means that the night-sky is often also partially or completely obscured, further reducing the light levels at night. These factors result in a night-time landscape with a very low VAC, as illustrated by the last two photographs of Figure 7.

Based on the above summary, the visual absorption capacity of the overall project study area is rated as being **low (3)**.

5.2.1.5 Sense of place

According to Lynch (1992), in the built or anthropocentric landscape sense of place is “*the extent to which a person can recognise or recall a place as being distinct from other places, as having a vivid or unique, or at least particular character of its own*”. From an anthropology perspective, Low (1992) defines sense of place (or “place attachment”) as “*the symbolic relationship formed by people giving culturally shared emotional/affective meanings to a particular space of piece of land that provides the basis for the individual’s and group’s understanding of and relation to the environment.... Thus, place attachment is more than an emotional and cognitive experience, and includes cultural beliefs and practices that link people to place.*”

Thus, sense of place means that a site has a uniqueness or distinctiveness, which distinguishes it from other places. The primary informant of these qualities is the spatial form and character of the natural landscape, together with any cultural transformation associated with historic use and habitation. A landscape can therefore be said to have a strong sense of place, regardless of whether it is predominantly natural or manmade.

Furthermore, in certain instances it is possible for a manmade landscape to have a distinct and definable negative sense of place, such as very large industrial operations or desolated development sites. This criteria is arguably the most ambiguous in the field of visual assessment, as it is largely open to the interpretation of the individual and may vary widely based on any number of factors. However generally speaking, in instances where high landscape visual quality and strong sense of place coincides, the visual resource value is considered to be high.

Prior to the establishment of the pilot project infrastructure the peninsula was therefore exclusively characterised by low intensity rural land uses, with the local population being intrinsically tied with the natural landscape.



The study area is mostly characterised by long range views, and a relatively narrow range of natural colours. Expansive landscape alterations (left) or the inclusion of more brightly coloured objects such as building roofs are therefore very visible, even over considerable distances (right)



The low horizon line of much of the study area (left) means that any vertically prominent structures that protrude above it such as the existing drill rig, are highly prominent (right)



The existing landscape is characterised by very low levels of development and almost no artificial night-time illumination (left). The very low ability of this landscape to absorb impact at night is illustrated by the existing contractor camp and especially drill rig (right), which are clearly visible over a distance of more than 3 km.

Figure 7: The study area is characterised by low levels of visual absorption capacity

The peninsula is sparsely inhabited, with the local inhabitants living in a number of small villages spaced along the lake shoreline. The livelihoods of the local population is sustained by fishing, as well as subsistence and small-scale commercial cattle ranching, with craft-based trades also being significant. These elements all form part of the visual identity and character of the study area, and result in a distinctly rural aesthetic. The study area is also characterised by numerous sites and features of strong cultural and spiritual significance, several of these to the extent that their locations are being kept confidential in terms of the ESIA process (Golder, 2017).



By contrast, the tall well pad 2 pilot drill rig forms a prominent vertical and visually contrasting landmark in the landscape. Other components of the pilot infrastructure are less prominent, but still form strongly linear visual pathways through the landscape, especially the airfield and access road excavations.

The pre-development study area possesses a sense of timelessness, largely owing to the centuries-old, subsistence-based rural lifestyle of the local people. This attribute is heightened by the dramatic and unique visual context within which the site is located. By contrast, the existing well pad 2 infrastructure, site camp and access road excavations are considered to be visually intrusive, and in visual conflict with the pre-existing sense of place. A number of land use examples within the study area are illustrated by Figure 8.



The pre-existing land uses within the study area are mainly subsistence fishing (left) and small-scale agriculture including cattle ranching (right)



The visual character of the pre-existing manmade elements in the study area retain a distinctly rural aesthetic



The existing well pad 2 rig forms a prominent vertical landmark that contrasts with the study area sense of place

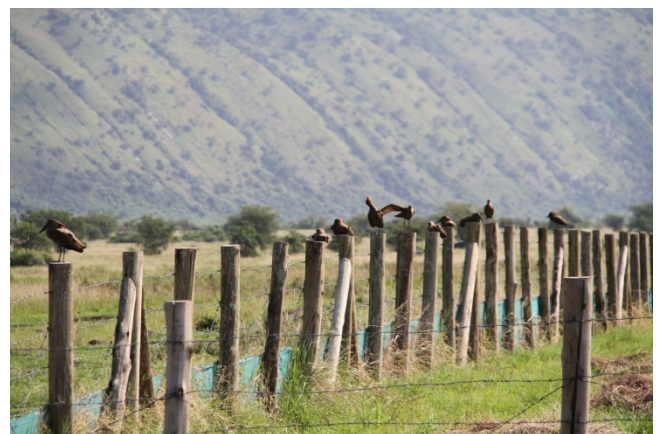

Linear infrastructure form disruptive visual pathways through the landscape

Figure 8: Land use within the main project study area



A further aspect of the visual baseline that needs to be considered is that of atmospheric conditions, as this factor can greatly influence how a landscape is perceived by viewers, as well as the distance over which views are possible. Low cloud and high atmospheric humidity frequently reduces visibility in the region and limits views to medium range distances. Dense fog makes longer range views impossible even from elevated locations, while clear conditions enable views over great distances from the same elevated positions. Partially cloudy conditions often also result in dramatic sunsets that greatly contribute to the appeal and resource value of the landscape.

These aspects are demonstrated in Figure 9 below.



Atmospheric humidity results in hazy conditions which may partially obscure objects over greater distances



Conversely clear conditions enable longer range views

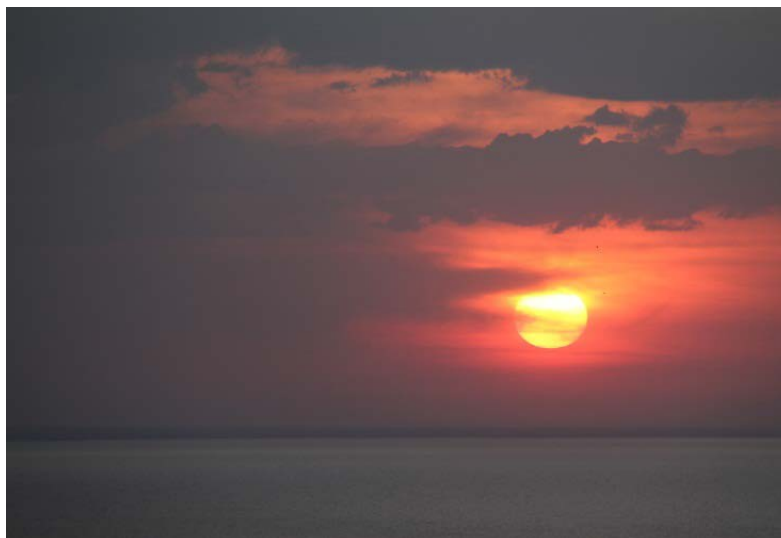

Partial cloud cover may give rise to highly appealing visual conditions

Figure 9: Atmospheric conditions can greatly influence the visual appearance of the landscape and contribute to visual appeal and sense of place

Based on the above summary, the uniqueness and sense of place of the pre-development visual landscape as a whole is considered to be irreplaceable, and is therefore rated as **high (3)**.

5.2.2 Visual resource value assessment

The visual resource value ratings assigned to each of the visual attributes determined in Section 5.2.1 are summarised in Table 1 below.



Table 1: Production facility study area visual resource summary

Visual baseline attribute	Topography	Water bodies	Vegetation	VAC	Sense of place
Visual resource value score	3 (high)	3 (high)	2 (moderate)	3 (low VAC, thus high susceptibility to change)	3 (high)
Total visual resource value score					14

The total score was subsequently applied to the criteria summarised in Table 2, in order to determine the visual resource value of the study area.

Table 2: Study area visual resource value determination

Visual resource value score	Criteria
13 – 15 = High visual resource value	Pristine or near-pristine condition / natural areas with little to no visible human intervention visible / characterised by highly scenic or attractive natural features, or cultural heritage sites with high historical or social value and visual appeal / Areas that exhibit a strong positive character with valued features that combine to give the experience of unity, richness and harmony. These are landscapes that may be considered to be of particular importance to conserve and which may be sensitive to change.
9 – 12 = Moderate visual resource value	Partially transformed or disturbed landscape / human intervention visible but does not dominate view / scenic appeal of landscape partially compromised / noticeable presence of incongruous elements / Areas that exhibit positive character but which may have evidence of degradation / erosion of some features resulting in areas of more mixed character. These landscapes are less important to conserve, but may include certain areas or features worthy of conservation.
5 – 8 = Low visual resource value	Extensively transformed or disturbed landscape / human intervention dominates available views / scenic appeal of landscape greatly compromised / visual prominence of widely disparate or incongruous land uses and activities / Areas generally negative in character with few, if any, valued features. Scope for positive enhancement frequently occurs.

From the assessment performed in Section 5.2 and the score ranges presented in the table above, it is concluded that the visual resource value of the production facility study area as a whole is **high**. This assessment is based on the appeal of its respective biophysical and land use characteristics individually, as well as the innate and strongly defined sense of place of the study area as a single entity.

An assessment of the expected visual impacts that would arise as a consequence of the proposed project development was subsequently conducted as described in Section 5.3.

5.3 Visual impact assessment

5.3.1 Project phases and potential visual impacts

For the purposes of this VIA, the project can be divided into four phases, namely:

- Construction Phase - the construction period is deemed to be a secondary impact period that is comparatively short in relation to the operational phase. A number of the expected impacts, such as dust propagation and vehicular movement, will be associated with temporary construction-related activities. However, during this phase the degree of visual impact caused by the project is also expected to steadily increase as construction of the project infrastructure progresses;





- Operational Phase - This phase is deemed to cause the primary visual impact, as the climax of the project activities will take place then. The operational phase will also continue for the longest period of time, which is expected to be approximately 25 years;
- Decommissioning Phase - is deemed as part of mitigation for this project, as these activities will progressively assist in lessening the visual impact. Activities associated with the demolition and subsequent rehabilitation of disturbed areas will have a temporary negative impact, but will assist in returning the site to a condition that more closely resembles the pre-development visual baseline; and
- Long-term Phase – the VIA considers any residual visual impacts that may still be present when all rehabilitation measures have been implemented.

During each of these phases the proposed project will cause a number of physical changes to the visual landscape, all of which are expected to directly impact on the visual resource value of the study area. The key potential visual impacts associated with the project and the respective phases during which they are expected to occur were therefore identified, as indicated in Table 3:

Table 3: Anticipated visual impacts associated with the various project phases

Anticipated visual impact	Project phase			
	Construction	Operation	Decommissioning	Long-term
1) Dust pollution (temporary impact)	yes	no	yes	no
2) Increased activity on site from construction equipment/plant, vehicles, and materials handling (temporary impact)	yes	No/ sporadic	yes	no
3) Alteration of site topography and loss of vegetation cover	yes	yes	yes	likely
4) Introduction of visually intrusive infrastructure/industrial land use – CPF, Drill rig moving to four separate well pads, permanent support infrastructure and escarpment access road	yes	yes	No/ progressively decreases	no
5) Light pollution at night	yes	yes	yes	no
6) Loss of sense of place (resultant impact)	yes	yes	yes	likely

The level of visibility, visual intrusion, and proximity of the production facility to identified receptors was evaluated in Sections 5.3.2.1 to 5.3.2.3 respectively. The levels of visibility and visual exposure was semi-quantitatively determined from a series of viewsheds that were modelled using the site topography and project layout drawings. The visual intrusion of the primary impacts (impacts 3 to 5 in Table 3) was subjectively estimated based on the anticipated appearance of the various project infrastructure components. Loss of sense of place (impact 6) is a consequence of these impacts, and was dealt with as a separate impact during the impact magnitude and significance determination stages.

Furthermore, the short-term or sporadic impacts associated with the construction and decommissioning phases, namely dust propagation and increased vehicular activity (impacts 1 and 2), are secondary impacts





of the above primary impacts and were therefore not assessed further. However, mitigation measures to address these impacts were proposed in Section 5.3.6.

5.3.2 Visual impact criteria

5.3.2.1 Level of visibility

The expected level visibility is defined as the sections of the study area from which the proposed project or its constituent elements may be visible. This area was determined by conducting a viewshed analysis and using Geographic Information System (GIS) software with three-dimensional topographical modelling capabilities, including viewshed and line-of-sight analyses (cross-sections).

The basis for the viewshed analysis was a digital elevation model (DEM) and the viewsheds were modelled on the above-mentioned DEM using Global Mapper 15® software. The receptor height was set to 1.5 m and the various infrastructure elements associated with the production facility given heights indicated by the client. In this fashion, the level of visibility based on the results of the viewshed analysis was then rated as shown in Table 4, as a function of how much of the study area is indicated as being visually exposed to the project infrastructure:

Table 4: Level of visibility rating

Level of theoretical visibility of project element	Visibility rating
Less than a quarter of the total project study area	Low
Between a quarter and half of the study area	Moderate
More than half of the study area	High

5.3.2.2 Visual exposure

The visual impact of a development diminishes at an exponential rate as the distance between the observer and the object increases – refer to Figure 10. Relative humidity and fog in the area directly influence the effect. Increased humidity causes the air to appear greyer, diminishing detail. Thus, the impact at 1 000 m would be 25% of the impact as viewed from 500 m. At 2 000 m it would be 10% of the impact at 500 m. The inverse relationship of distance and visual impact is well recognised in visual analysis literature (Hull, R.B and Bishop, I.E, 1998) (Hull, R.B and Bishop, I.E, 1998) and was used as important criteria for this study.

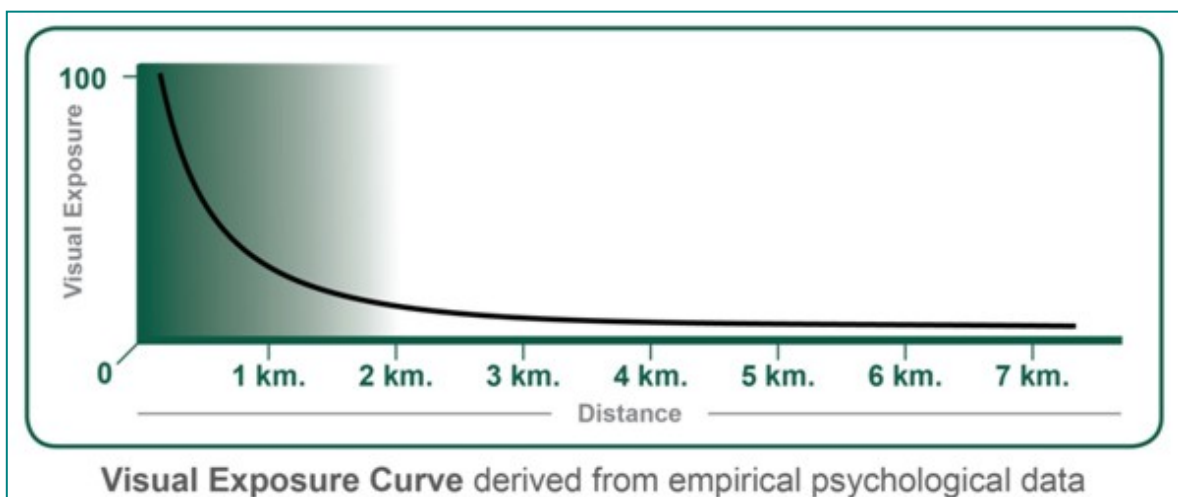

Figure 10: Visual impact vs. visual exposure distance





Thus, visual exposure is an expression of how close receptors are expected to get to the proposed interventions on a regular basis. For the purposes of this assessment, visual exposure is defined as summarised in Table 5:

Table 5: Level of visual exposure

View range/receptor distance from visual impact source	Visual exposure rating
Close-range views / views over a distance of 500 m or less	Low
Medium-range views / views of 500 m to 2 km	Moderate
Long-range views / views over distances greater than 2 km	High

Two sets of viewsheds were generated, namely receptor- and impactor-based. The first set considers the project infrastructure from the perspective or vantage point of potential visual receptors (such as local villages or roads within the study area). Representative locations within the study area were identified for this purpose, to develop an understanding of how exposed these receptors may be to the impact.

The second set is generated from the source of the visual impact itself, in this case the production facility infrastructure, to develop an understanding of the spatial extent and distribution of the visual impact within the study area. The impactor-based viewsheds can also be used to develop an understanding of the potential extent of exposure to light at night. However as previously mentioned, the visible impact of brightly lit structures at night may extend much further than the level of visibility of same infrastructure during the day, due to the heightened contrast between the light source and black background.

Together these viewsheds form a picture of the expected level of visibility and therefore spatial extent of the visual impact associated with the project, as well as how identified receptors may be impacted by it. Furthermore, this information is used later on to identify appropriate visual mitigation measures to the visual impacts, where possible. The results of the above viewsheds are briefly summarised below.

5.3.2.2.1 Receptor-based viewsheds

- Kyakapere, located in the northern part of the study area (Figure 11): From this position the majority of the project infrastructure will likely be obscured or only partially visible, however exposure to well pad 4 will be high as it is located within 500 m of this location. The level of visibility of the project site as a whole from this position will therefore be low, however the degree of visual exposure will be high.
- Kyabasambu, located near the centre of the study area (Figure 12): From here almost the entire production complex will be visible, as well as well pads 1, 2 and 4. Well pad 2, a section of the CPF as well as some of the support infrastructure will also be within 500 m of this location. The level of visibility and degree of visual exposure from this position will therefore be high.
- Nsonga north, located just south of the study area centre (Figure 13): Parts of the CPF and also supporting infrastructure will be visible from this location, as well as well pad 1. However all of the project infrastructure is located further than 500 m but nearer than 2 km from this location. The level of visibility and degree of visual exposure from this position will therefore be moderate.
- Nsonga south, located in the southern part of the study area (Figure 14): The majority of the production complex infrastructure is hidden from view from this location due to the gently sloping topography in the foreground. However this location is situated directly adjacent to well pad 3. The level of visibility of the project site as a whole from this position will therefore be low, however the degree of visual exposure will be high.

5.3.2.2.2 Impactor-based viewsheds

The range to which the project infrastructure will potentially be visible is significantly restricted to eastward, due to the presence of the high escarpment, which effectively screens the peninsula from view from most of the adjacent, higher-lying plateau. The visual range is at its shortest directly to the east at roughly 1.5 km, and around 4 km to the north and 6 km to the south respectively, with the areas of potential visibility covering the majority of the study area in between.





However, the visibility of the project infrastructure will be totally unobstructed towards the west over Lake Albert, and constitutes an international impact as especially the rig will be visible from the DRC section of the lake, from all 4 well pad locations. As already mentioned, the effect will be significantly more pronounced at night as the bright lights of the CPF and rig will be starkly visible against the near-black backdrop. These viewsheds are illustrated by Figure 15 to Figure 18. From an impactor-based perspective, the level of visibility of the project is therefore considered to be high, as most receptors within the study area will be exposed to aspects of the project to varying extents regardless of where they are located.

Based on the above criteria as well as the results of the viewshed analyses, the overall level of visibility of the production facility infrastructure within the study area is expected to be **high**. The level of visibility of the topographical alterations and loss of vegetation is expected to be **moderate**, as these impacts will occur close to ground level and should therefore more readily be hidden from view.

Furthermore, the level of visual exposure of receptors within the study area to the proposed project infrastructure is also expected to be **high**.

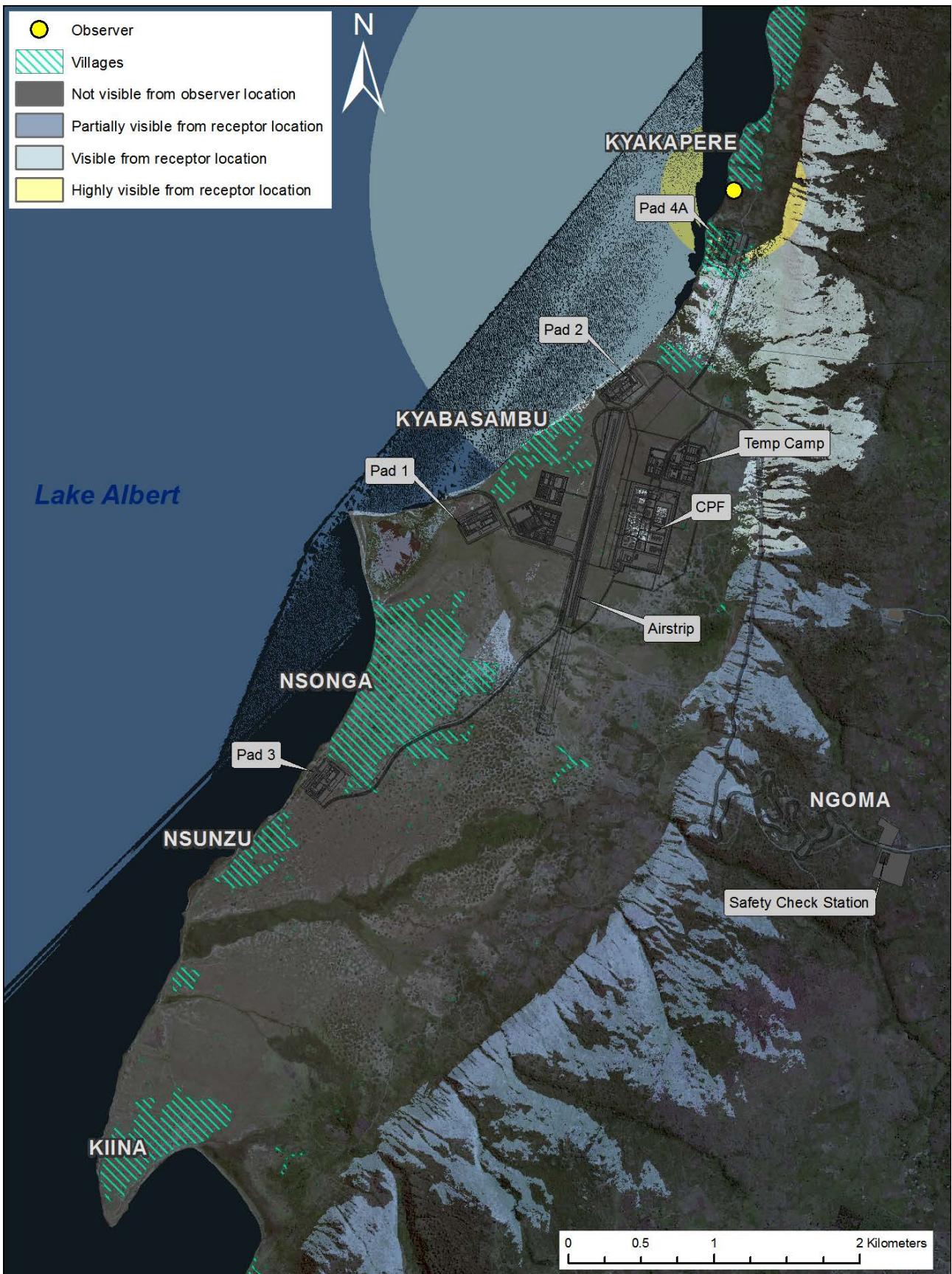

Figure 11: Visibility of project infrastructure from Kyakapere village (receptor-based viewshed)



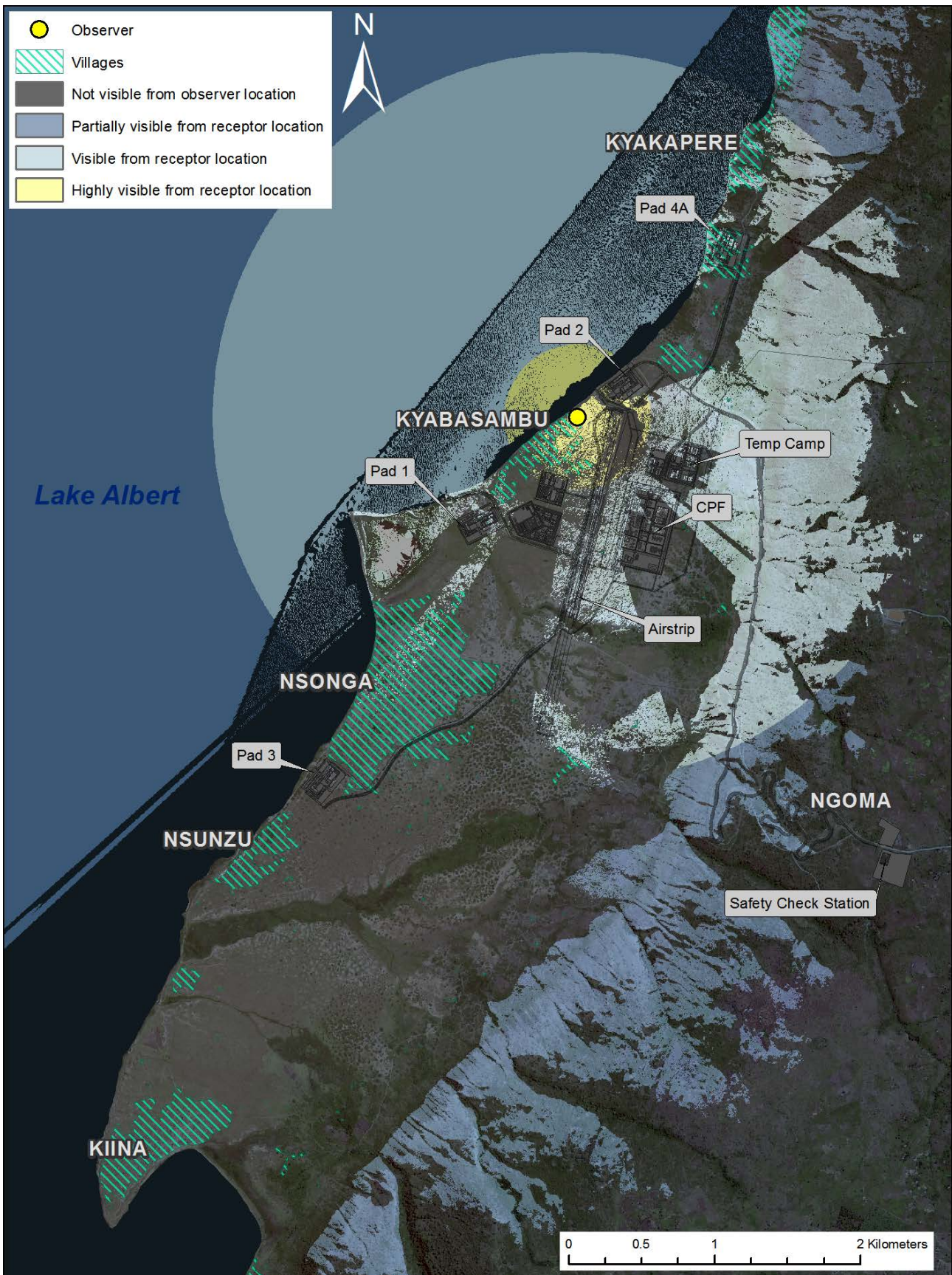

Figure 12: Visibility of project infrastructure from Kyabasambu village (receptor-based viewshed)



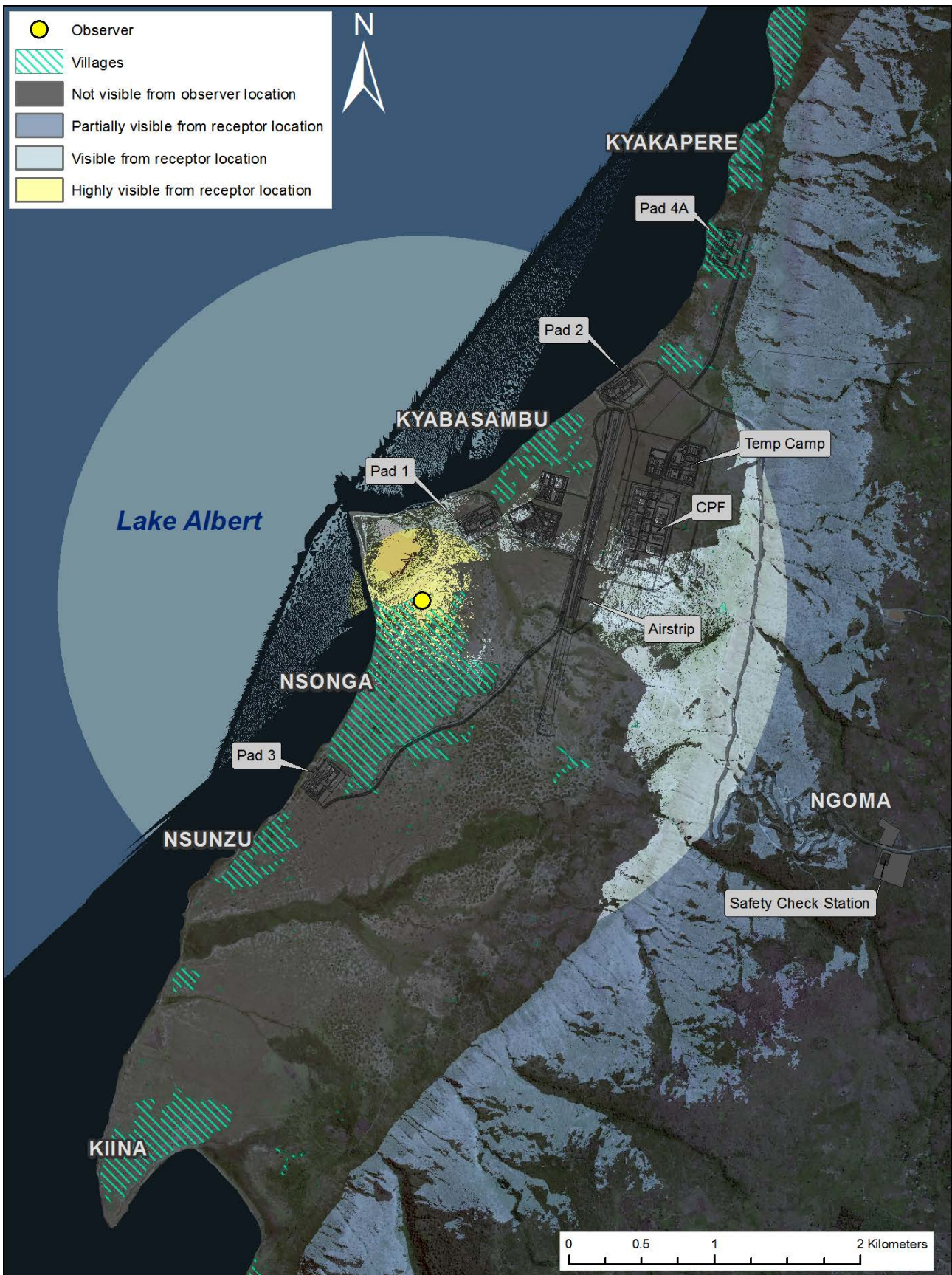

Figure 13: Visibility of project infrastructure from Nsonga village north (receptor-based viewshed)



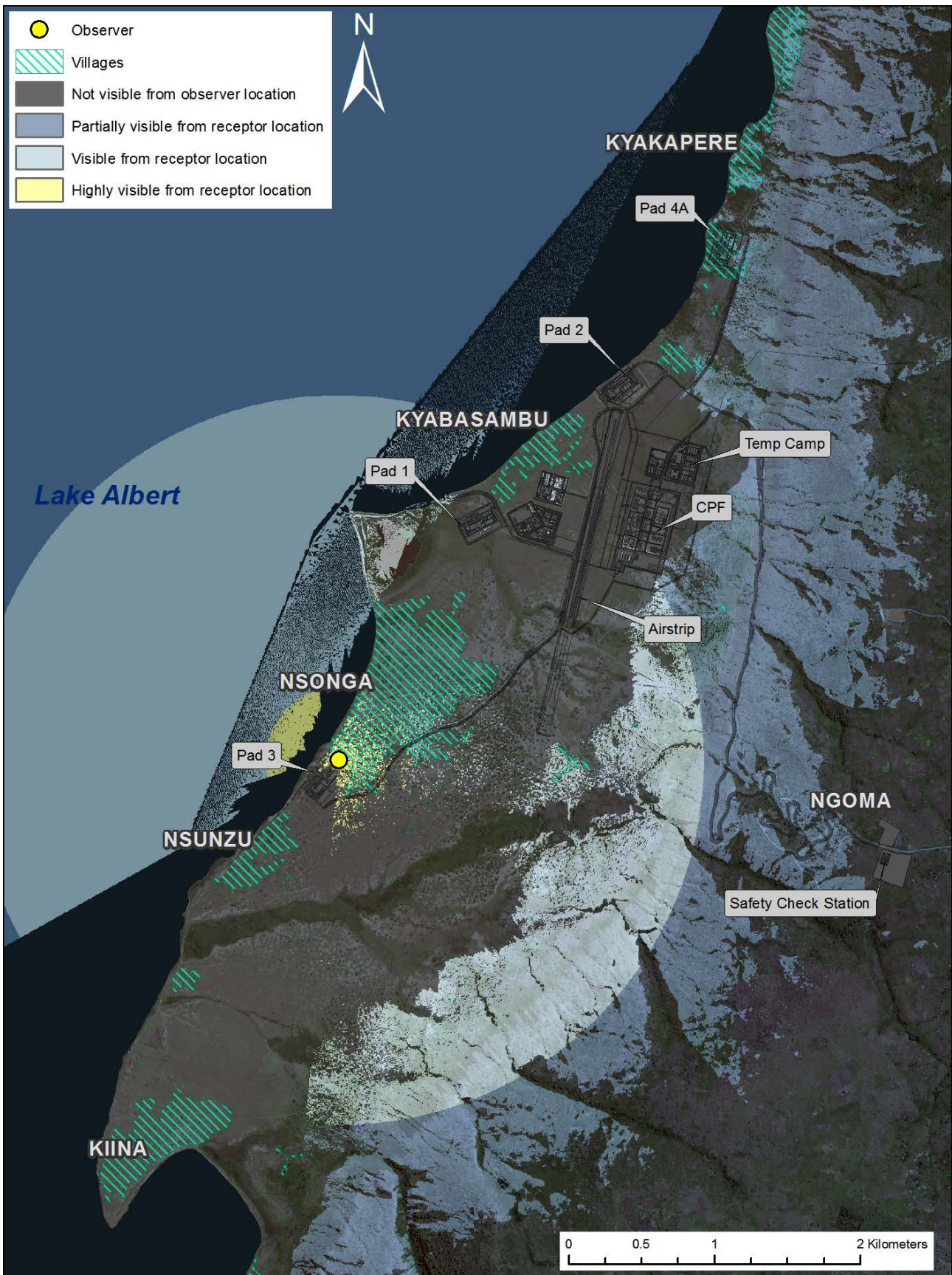

Figure 14: Visibility of project infrastructure from Nsonga village south (receptor-based viewshed)



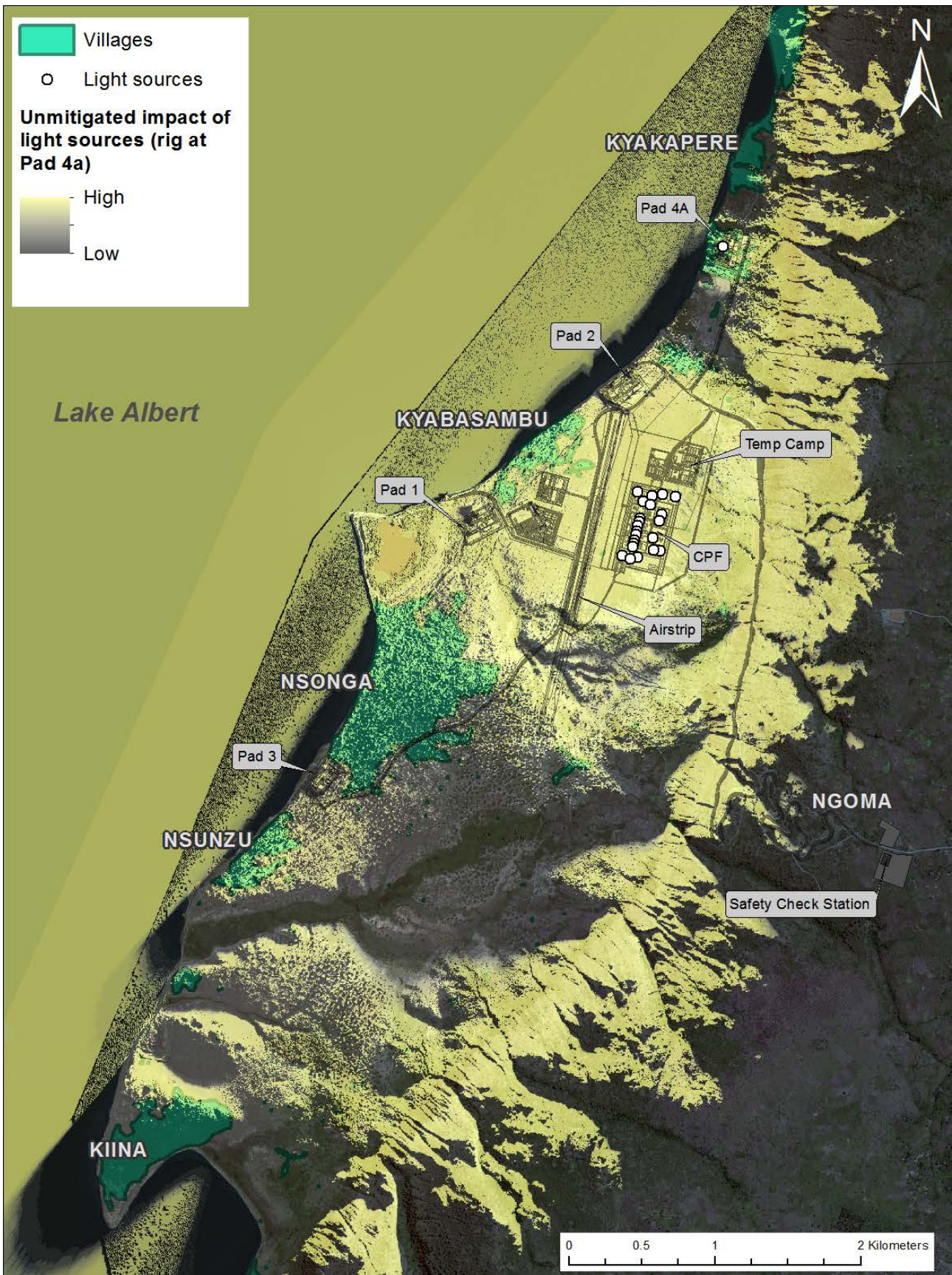

Figure 15: Night-time illumination within study area for CPF and drill rig at well pad 4 (impactor-based viewshed)



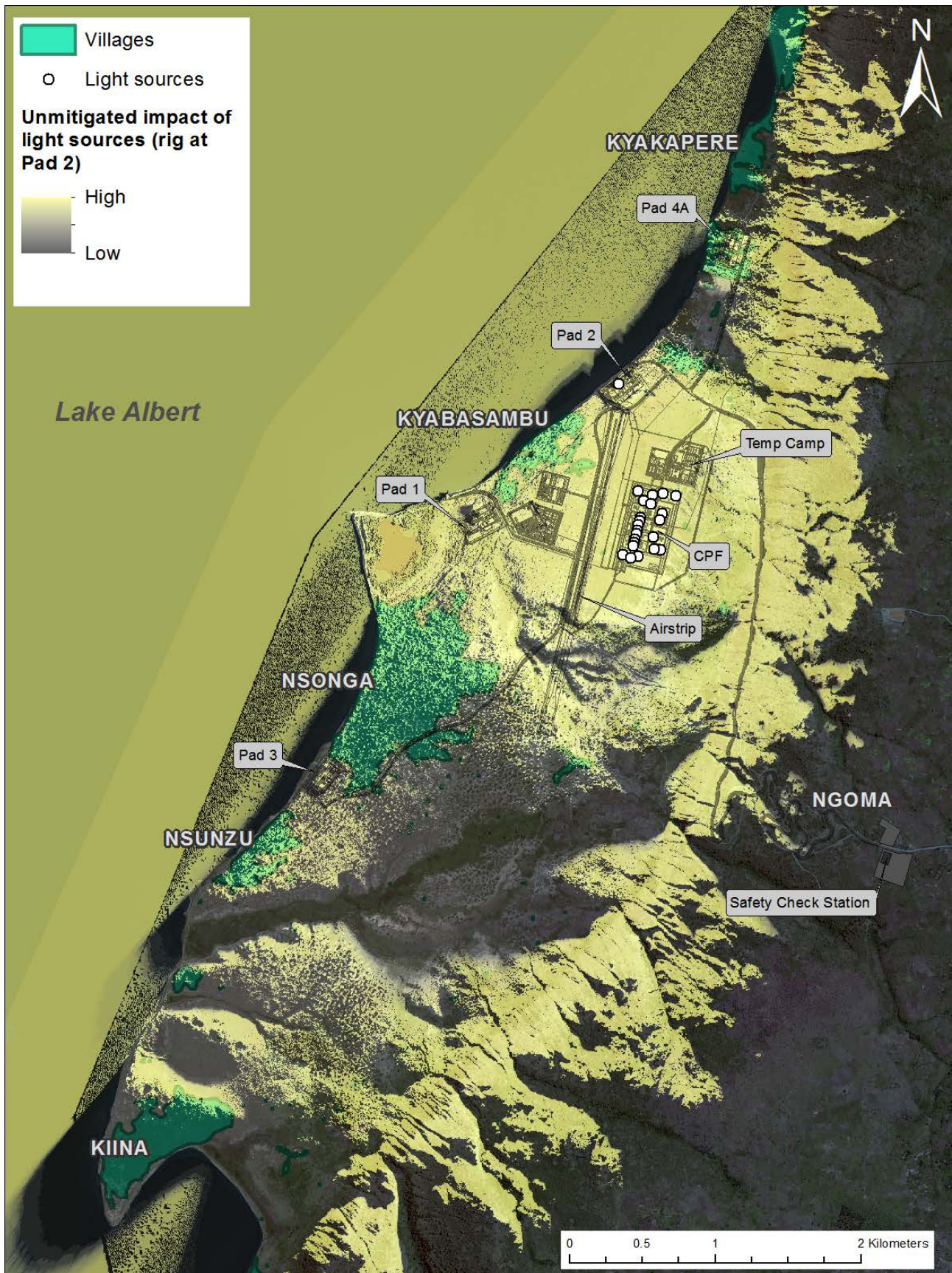

Figure 16: Night-time illumination within study area for CPF and drill rig at well pad 2 (impactor-based viewshed)



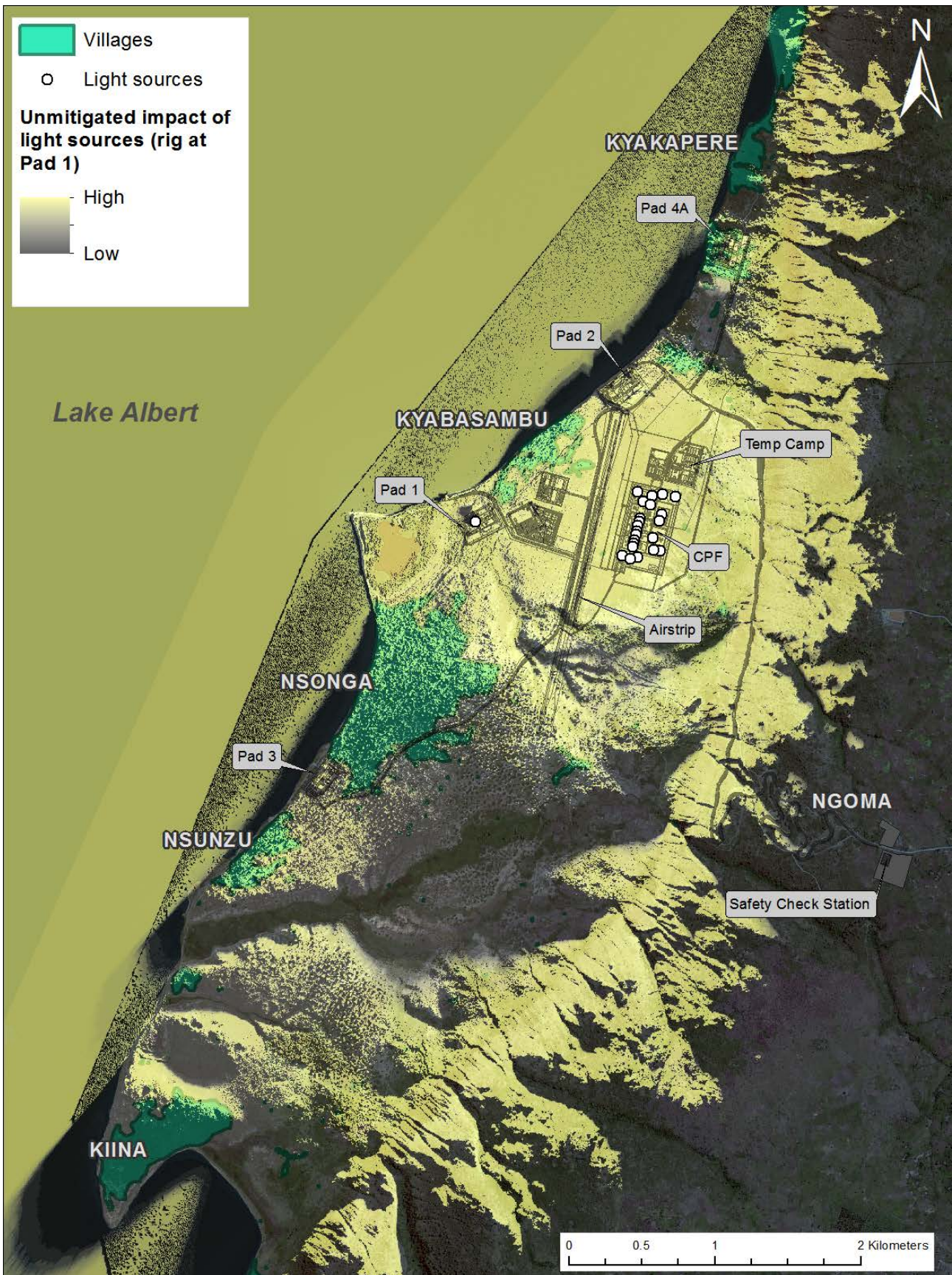

Figure 17: Night-time illumination within study area for CPF and drill rig at well pad 1 (impactor-based viewshed)



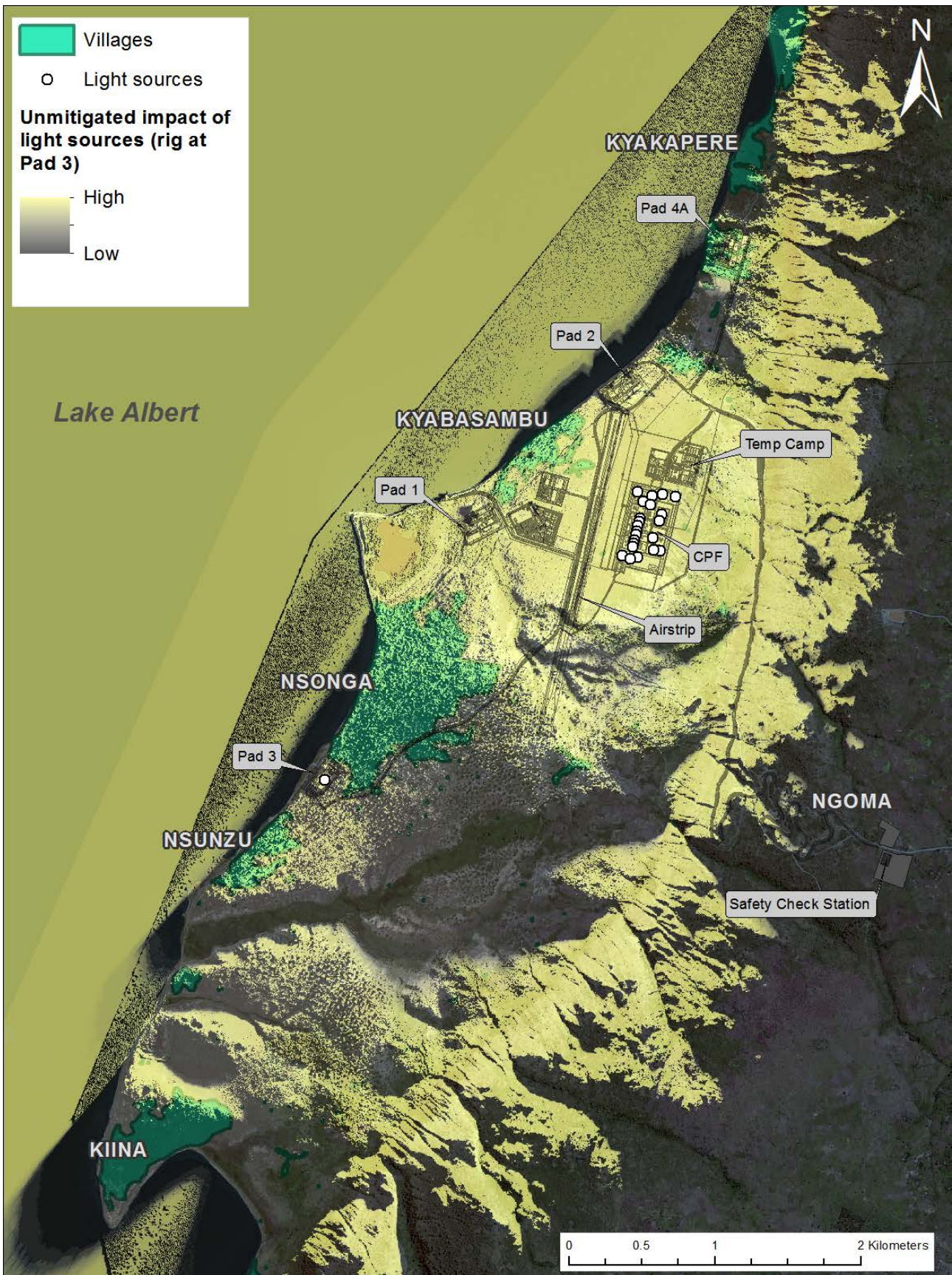

Figure 18: Night-time illumination within study area for CPF and drill rig at well pad 3 (impactor-based viewshed)





5.3.2.3 Visual intrusion

Visual intrusion deals with how well the project components fit into the ecological and cultural aesthetic of the landscape as a whole. An object will have a greater negative impact on scenes considered to have a high visual quality than on scenes of low quality, because the most scenic areas have the "most to lose".

The visual impact of a proposed landscape alteration also decreases as the complexity of the context within which it takes place, increases. If the existing visual context of the site is relatively simple and uniform any alterations or the addition of human-made elements tend to be very noticeable, whereas the same alterations in a visually complex and varied context do not attract as much attention. Especially as distance increases, the object becomes less of a focal point because there is more visual distraction, and the observer's attention is diverted by the complexity of the scene (Hull, R.B and Bishop, I.E, 1998). The expected level of visual intrusion of the main project infrastructure elements is assessed below.

The visual intrusion caused by the project at day is mainly as a result of the bright, contrasting primary colours and strongly geometric shapes of the production infrastructure, as well as vertical height in the case of the drill rig Figure 19. The level of visual intrusion is further emphasised when this infrastructure is viewed against the sky as backdrop, which further emphasises its manmade and artificial appearance.

It is anticipated that the CPF and especially supporting infrastructure components will be somewhat less intrusive, mainly due to their smaller height and somewhat simpler shapes. Furthermore when viewed against the escarpment as backdrop the effect is somewhat muted, as the existing access road excavations could be argued to be more intrusive than the additional infrastructure (Figure 20).

The greatest degree of visual intrusion by far is expected to occur at night when the infrastructure will be brightly lit, as already the case with the existing rig and support infrastructure. The effect is most conspicuous in views where there is no existing infrastructure present, as indicated by Figure 21. However, the effect is still clearly evident in instances where the existing and additional infrastructure is viewed from relatively close, such as the nearby villages (Figure 22). Furthermore, the effect is particularly drastic when viewed from elevated locations such as along the escarpment, as there is no vegetation or other landscape elements that could potentially screen or obscure the light (Figure 23).

Based on the above evaluation the day-time visual intrusion of the project infrastructure and associated changes in site topography and loss of vegetation cover is rated as **moderate**, whereas the night-time level of visual intrusion is rated as **high**.



Figure 19: The well pad drill rig is the most visually intrusive element of the project



Figure 20: Daytime view of the CPF site from the northwest, after construction of the project infrastructure



Figure 21: Night-time view of the CPF site from the northwest, before (top) and after (bottom) construction of the project infrastructure



Figure 22: Night-time view of the permanent camp, CPF site and well pads 1 and 2 positions, before (top) and after (bottom) construction of the project infrastructure

Note: in the “after” (bottom) image, the drill rig has been moved from well pad 2 further north to well pad 1, located approximately 500 m from the viewer



Figure 23: Night-time panoramic view of the peninsula and production site from the southeast along the escarpment, before (top) and after (bottom) construction of the project infrastructure



- In summary, the visual impact criteria ratings for each of the primary project impacts performed in Section 5.3.2 above are indicated in

■

Table 7.

Table 6: Visual impact criteria rating

Visual impact	Visual impact criteria			Total rating score
	Visibility	Visual exposure	Visual intrusion	
Alteration of site topography and loss of vegetation cover	Moderate (2)	High (3)	Moderate (2)	7 (Moderate)*
Visually intrusive infrastructure (day-time impact)	High (3)	High (3)	Moderate (2)	8 (High)*
Light pollution (night-time impact)	High (3)	High (3)	High (3)	9 (High)*

(* Where for the total rating score: 3-5 = low; 6-7 = moderate; and 8-9 = high)

5.3.3 Impact intensity

The intensity of each visual impact is determined using

Table 7; as a function of the visual resource value of the receiving landscape study area, together with the visual impact criteria (Table 6). The visual resource value of the production facility study area as a whole is high (see Section 5.2).

Table 7: Visual impact intensity

Visual resource value	Visual impact criteria rating		
	High	Moderate	Low
High	High (4)	High (4)	Moderate (3)
Moderate	High (4)	Moderate (3)	Low (2)
Low	Moderate (3)	Low (2)	Very Low (1)

Accordingly, the intensity of each impact is as follows:

- Alteration of site topography and loss of vegetation cover – **high (4)**;
- Visually intrusive infrastructure (day-time impact) – **high (4)**;
- Light pollution (night-time impact) – **high (4)**; and
- Resultant loss of sense of place as secondary impact – **high (4)**.

5.3.4 Impact magnitude

The process followed from Sections 5.2.1 to 5.3.3 above is specific to the discipline of visual impact assessment, and is based on industry-accepted standards and criteria. However, the determination of the impact magnitude and significance was done using standard impact assessment criteria, in order to allow for





the results of the VIA to be incorporated into the overall ESIA process and deliverables. This process was also done so that the impact assessment process can be more readily understood by stakeholders.

To help readers understand the results of the impact assessment, the VIA aimed to answer the following questions to derive the magnitude of the impact:

- Is the effect good or bad? This is the direction of an effect.
- How large an area will be affected? How far will the effect reach? This is the geographic extent of an effect.
- How long will the effect last? This is the duration of an effect.
- Will the effect be reversible or not?

Each of these is discussed in more detail below.

5.3.4.1 *Direction*

Direction describes the trend of the effect compared with baseline conditions. There are three options for direction:

- Adverse – effect is worsening or is undesirable;
- Neutral – effect is not changing compared with baseline conditions and trends; and
- Positive – effect is improving or is desirable.

5.3.4.2 *Geographic extent*

Geographic extent describes the quantitative measurement of area within which an effect occurs. Effects are described in terms of whether they are limited to the site or local study area, the region, or extend farther:

- Local (1) – effect is limited to the project site and immediate surroundings;
- Regional (2) – effect extends beyond the immediate surroundings, but is limited to the general region; and
- Beyond regional (3) – effect extends beyond the region to a provincial/national or international level.

5.3.4.3 *Duration*

Duration refers to how long an effect lasts. Duration is described in relation to the phases of the development of the project, although effects may last longer than the phases of the project for some valued components. The following framework was used: construction, operations, decommissioning, and far-future.

For the purposes of this VIA, the far future is a duration criterion that is meant to capture effects lasting several generations after decommissioning and rehabilitation. This relates to effects that the project may have on the area's environmental and social sustainability (or not), including cumulative impacts.

- Short-term (1) – effect is limited to the construction period (~2 years), or the period of decommissioning activities (~2 years);
- Medium-term (2) – effect extends throughout the project operations, that is, 25 years;
- Long-term (3) – effect extends beyond the 25 years of operation; and
- Far future (4) – effect extends more than 30 years after closure.

5.3.4.4 *Reversibility*

This criterion describes whether the effect is reversible or not. This can be associated with duration, as many effects eventually could be considered to be reversible (that is, in geological time). However, the



extinction of a species can be considered as irreversible. For the purposes of the VIA, the level of reversibility was defined as follows:

- Fully reversible (1) – all visual impacts will cease when the project infrastructure is removed/activity has ceased;
- Largely reversible (2) – residual or secondary visual impacts remain when the project infrastructure is removed but are expected to diminish over time or are minor in relation to the primary visual impacts;
- Partially reversible (3) – permanent residual or secondary impacts will remain that are not expected to diminish; and
- Non-reversible (4) – the primary project visual impacts are permanent as a consequence of the nature and lifespan of the project.

The magnitude of each of the primary visual impacts were subsequently determined using the impact intensity determine in Section 5.3.3 above, as well as the above criteria, indicated in Table 8.

Table 8: Visual impact magnitude

Visual impact (Adverse)	Impact magnitude determination criteria				Total magnitude score
	Intensity	Extent	Duration	Reversibility	
Alteration of site topography and loss of vegetation cover	High (4)	Local (1)	Long-term (3)	Largely (2)	10
Visually intrusive infrastructure	High (4)	Local (1)	Medium-term (2)	Largely (2)	9
Light pollution	High (4)	Beyond regional (3)	Medium-term (2)	Fully (1)	10
Loss of sense of place	High (4)	Local (1)	Long-term (3)	Largely (2)	10

The total magnitude score was applied to the criteria summarised in Table 9 in order to determine the magnitude of each visual impact.

Table 9: Magnitude assessment criteria and rating scale

Criteria	Rating scales
Magnitude (the expected magnitude or size of the impact)	4-6 = Negligible: where the impact affects the environment in such a way that natural, and /or cultural and social functions and processes are negligibly affected and valued, important, sensitive or vulnerable systems or communities are negligibly affected.
	7-9 = Low: where the impact affects the environment in such a way that natural, and/or cultural and social functions and processes are minimally affected and valued, important, sensitive or vulnerable systems or communities are minimally affected. No obvious changes prevail on the natural, and / or cultural/ social functions/ process as a result of project implementation
	10-12 = Moderate: where the affected environment is altered but natural, and/or cultural and social functions and processes continue albeit in a modified way, and valued, important, sensitive or vulnerable systems or communities are moderately affected.
	13-15 = High: where natural and/or cultural or social functions and processes are altered to the extent that they will temporarily or permanently cease, and valued, important, sensitive or vulnerable systems or communities are substantially affected. The changes to the natural and/or cultural / social- economic processes and functions are drastic and commonly irreversible





Accordingly, the magnitude of each impact is as follows:

- Alteration of site topography and loss of vegetation cover – **moderate**;
- Visually intrusive infrastructure (day-time impact) – **low**;
- Light pollution (night-time impact) – **moderate**; and
- Resultant loss of sense of place as secondary impact – **moderate**.

5.3.5 Impact significance

To determine the significance of a visual impact, the expected receptor sensitivity is determined based: on the number of people that are likely to be exposed to a visual impact (incidence factor); and their expected perception of the value of the visual landscape and project impact (sensitivity factor). The sensitivity factor is then considered in terms of the overall magnitude of the visual impact, as was determined in Section 5.3.4.

5.3.5.1 Visual receptor sensitivity

Potential viewers or visual receptors are people that might see the proposed development, as visual impact is primarily concerned with human interests and perceptions. Receptor sensitivity refers to the degree to which an activity will actually impact on receptors and depends on how many persons see the project, how frequently they are exposed to it and their perceptions regarding aesthetics. Receptors of the proposed project can be broadly categorised into two main groups, namely:

- People who live or work in the area and who will frequently be exposed to the project components (resident receptors); and
- People who travel through the area, and are only temporarily exposed to the project components (transient receptors).

The project site is located in a remote section of the Ugandan countryside and is geographically isolated from major settlements. As such the number of resident receptors is limited and is restricted to the inhabitants of the nearby villages. However, local residents which have subsistence-based livelihoods are expected to attach a high level of value to landscape and are therefore expected to have a high level of sensitivity towards the project.

Due to the remote location of the site the number transient receptors is also expected to be limited. Specific locations within the greater region and other parts of the lake are tourism destinations of varying significance, the project site is remote from these localities and therefore expected to impact on a small number of transient receptors. Visitors to the region are therefore mainly tourists, and are expected to at least have a moderate level of sensitivity to significant changes in the appearance of the study area.

In summary, the overall number of people that will be visually exposed to the project (expressed as incidence factor) is expected to be **moderate** and is limited to only several thousand people. Conversely the overall sensitivity factor of the majority of receptors is expected to be **high**, as compared in Table 10.

Table 10: Visual receptor sensitivity



Receptor perceived landscape value	Number of receptors that will see the project (incidence factor)		
	Large	Moderate	Small
High	High	High	Moderate
Moderate	High	Moderate	Low
Low	Moderate	Low	Very low

Based on the very high perceived landscape value determined for the study area and the fact that a moderate number of people are expected to be exposed to the project, a **high** overall receptor sensitivity was determined for the project study area.

5.3.5.2 Impact significance assessment

The significance of each visual impact was subsequently determined as a function of the magnitude of the impact, together with the visual receptor sensitivity, as summarised in Table 11:

Table 11: Determination of impact significance

Magnitude of Impact	Sensitivity of receptor			
	Very low	Low	Medium	High
Negligible	1 Negligible	2 Minor	3 Minor	4 Minor
Low	2 Minor	4 Minor	6 Moderate	8 Moderate
Moderate	3 Minor	6 Moderate	9 Moderate	12 Major
High	4 Minor	8 Moderate	12 Major	16 Major

Accordingly, the significance of each impact is as follows:

- Alteration of site topography and loss of vegetation cover – **major**;
- Visually intrusive infrastructure (day-time impact) – **moderate**;
- Light pollution (night-time impact) – **major**; and
- Resultant loss of sense of place as secondary impact – **major**.





5.3.6 Visual impact mitigation

Visual mitigation can typically be approached in two ways, and usually a combination of the two methodologies is most effective. The first option is to implement measures that attempt to reduce the level of visibility of the source of a visual impact. Thus an attempt is made to "hide" the source of the visual impact from view, by placing visually appealing elements between the viewer and the source of the visual impact. The second option aims to minimise the degree of visual intrusion of the source of the impact by altering its physical appearance, i.e. shape/profile, colour and/or texture, or by decreasing the size of visual disturbance.

Construction and especially operational mitigation possibilities are likely to be limited for this project, as a result of functional/operational requirements of the infrastructure, and the visual character of the study area. Visual mitigation efforts will largely focus on screening the project infrastructure from view from the respective villages, as well as eliminating potential long term/post-closure impacts to ensure that the sense of place of the study area is restored.

The proposed visual mitigation measures for the individual visual impacts as identified are discussed below.

5.3.6.1 Temporary impacts

5.3.6.1.1 Dust pollution

- Water down any large bare areas associated with the construction and rehabilitation phases as frequently as is required to minimise airborne dust;
- Rehabilitate temporary bare areas as soon as feasible using appropriate vegetation species;
- Place a sufficiently deep layer of crushed rock or gravel over parking surfaces for vehicles and machinery ;
- Apply chemical dust suppressants if wet dust suppression is insufficient; and
- Implement a dust bucket fallout monitoring system.

5.3.6.1.2 Increased construction equipment/plant, vehicles, and materials handling activities

- Maintain the construction and rehabilitation phase sites in a neat and orderly condition at all times;
- Create designated areas for: material storage, waste sorting and temporary storage, batching, and other potentially intrusive activities;
- Limit the physical extents of areas cleared for material laydown, vehicle parking and the like as much as possible and rehabilitate these areas as soon as is feasible; and
- Repair project related erosion damage to steep or bare slopes as soon as possible and re-vegetate these areas using a suitable mix of indigenous grass species.

5.3.6.2 Daytime impacts - visually intrusive project elements

5.3.6.2.1 Vegetation screens

- Identify optimal locations for proposed vegetation screens on site, based on the results of the screened receptor and impactor-based viewshed analyses, as illustrated by Figure 24 to Figure 27, and Figure 30 to Figure 34 respectively. The extent and orientation of the individual tree screens should be determined on site by conducting line-of-sight evaluations from the respective villages to the individual project infrastructure sites (Figure 28);
- Conduct trials to identify the most suitable tree and shrub species to be utilised for establishing the vegetative screens. The selection of plant species must be cognisant of local soil conditions and rainfall, maintenance requirements, and expected lifespan and foliage density into consideration. In this regard it is anticipated that *Eucalyptus saligna* will likely be suitable, although management measures would need to be put in place to ensure that the plants do not become invasive and spread beyond the screens;



- Establish the vegetation screens as soon as possible, to minimise the time delay before the trees reach a suitable height to act as effective visual barriers. In this regard it must be noted that the trees will likely only be effective as screens once they reach a height of 7 or 8 m, which will require a number of years for the trees to achieve. The implication is that the project infrastructure will not be screened from view from the adjacent villages for a significant percentage of the operational lifespan of the project; and
- Construction of earthen embankments and berms should not be considered as visual screening measures, as these elements will cause additional visual impact due to their geometric and linear shapes. Furthermore the long-term impact of these artificial landforms will likely not be fully rehabilitated after closure, which will result in a permanent impact on the study area sense of place.

5.3.6.2.2 Architectural and landscaping measures

- To reduce the visual intrusion of the buildings, where feasible roofing and cladding material should not be white, shiny (e.g. bare galvanized steel that causes glare) or brightly coloured;
- Buildings and workshops exteriors should also be painted in colours that are complementary to the surrounding landscape, such as olive green, light grey, blue-grey, or variations of tan and ochre;
- Retain existing trees wherever possible, as they already provide valuable screening; and
- Appropriate landscaping using indigenous vegetation should be introduced within the permanent camp facility as well as entrance areas to other facilities, in order to create a more welcoming overall appearance.

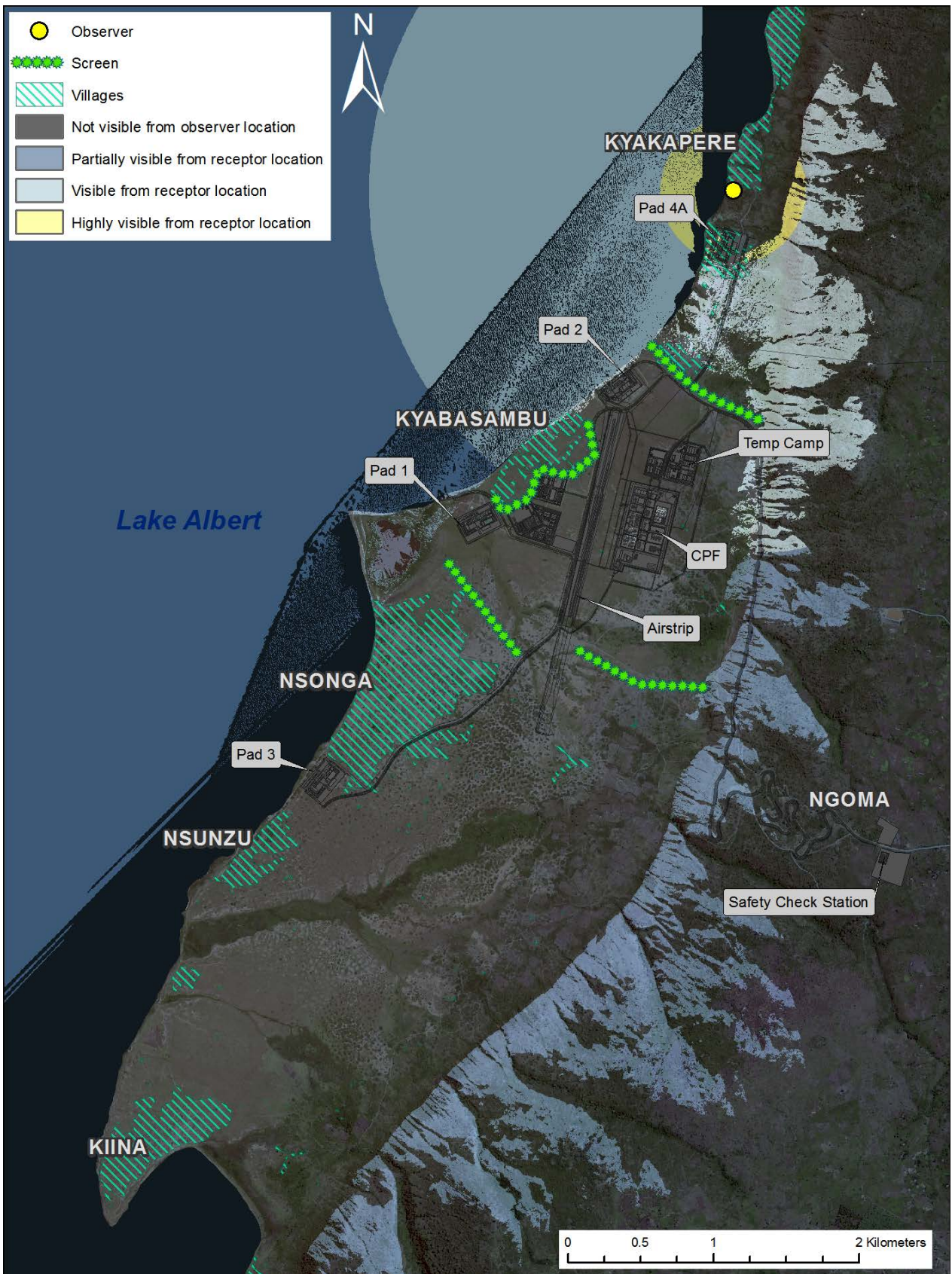

Figure 24: Visibility of project infrastructure from Kyakapere village (receptor-based viewshed) after visual screening

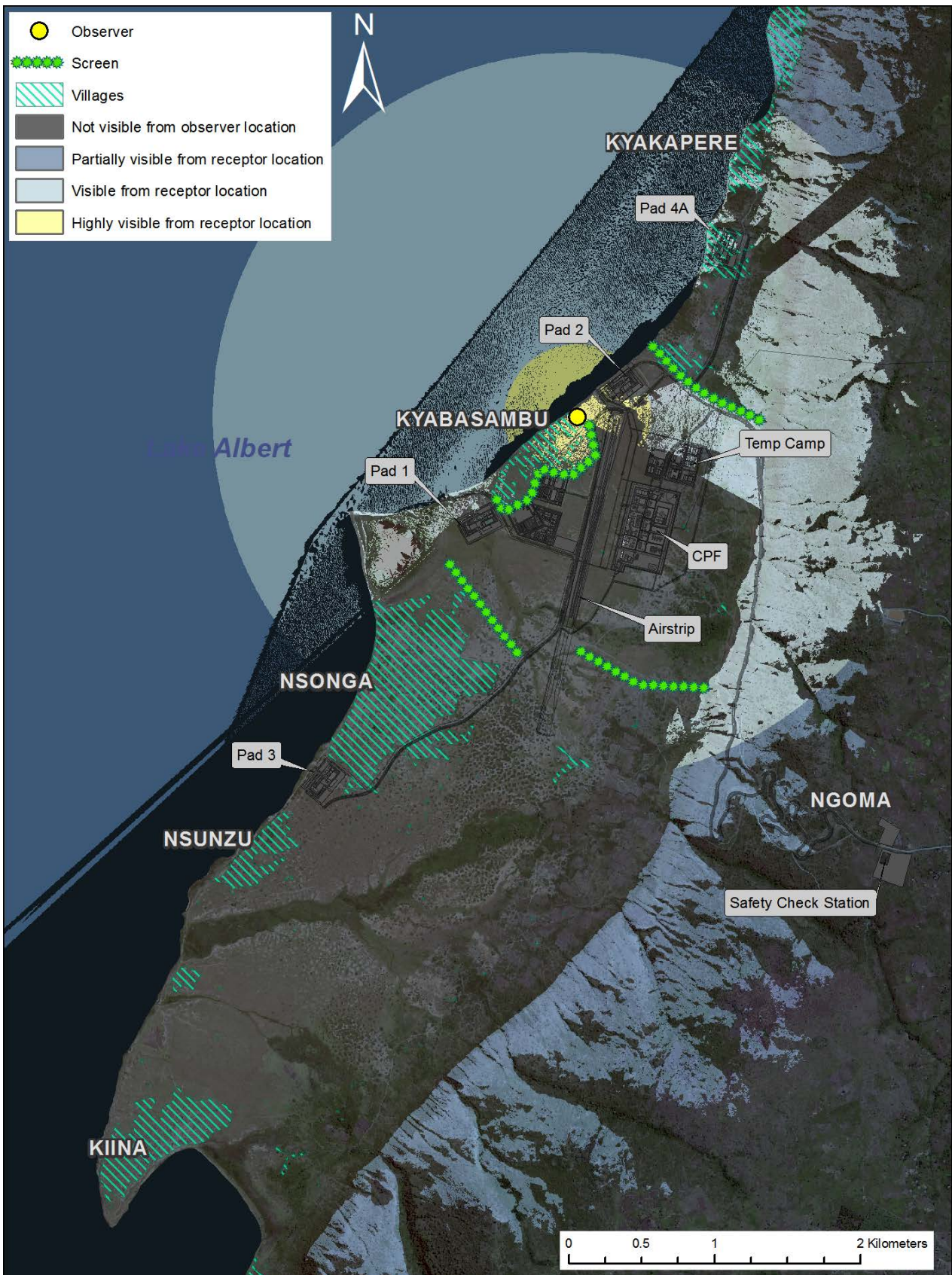

Figure 25: Visibility of project infrastructure from Kyabasambu village (receptor-based viewshed) after screening

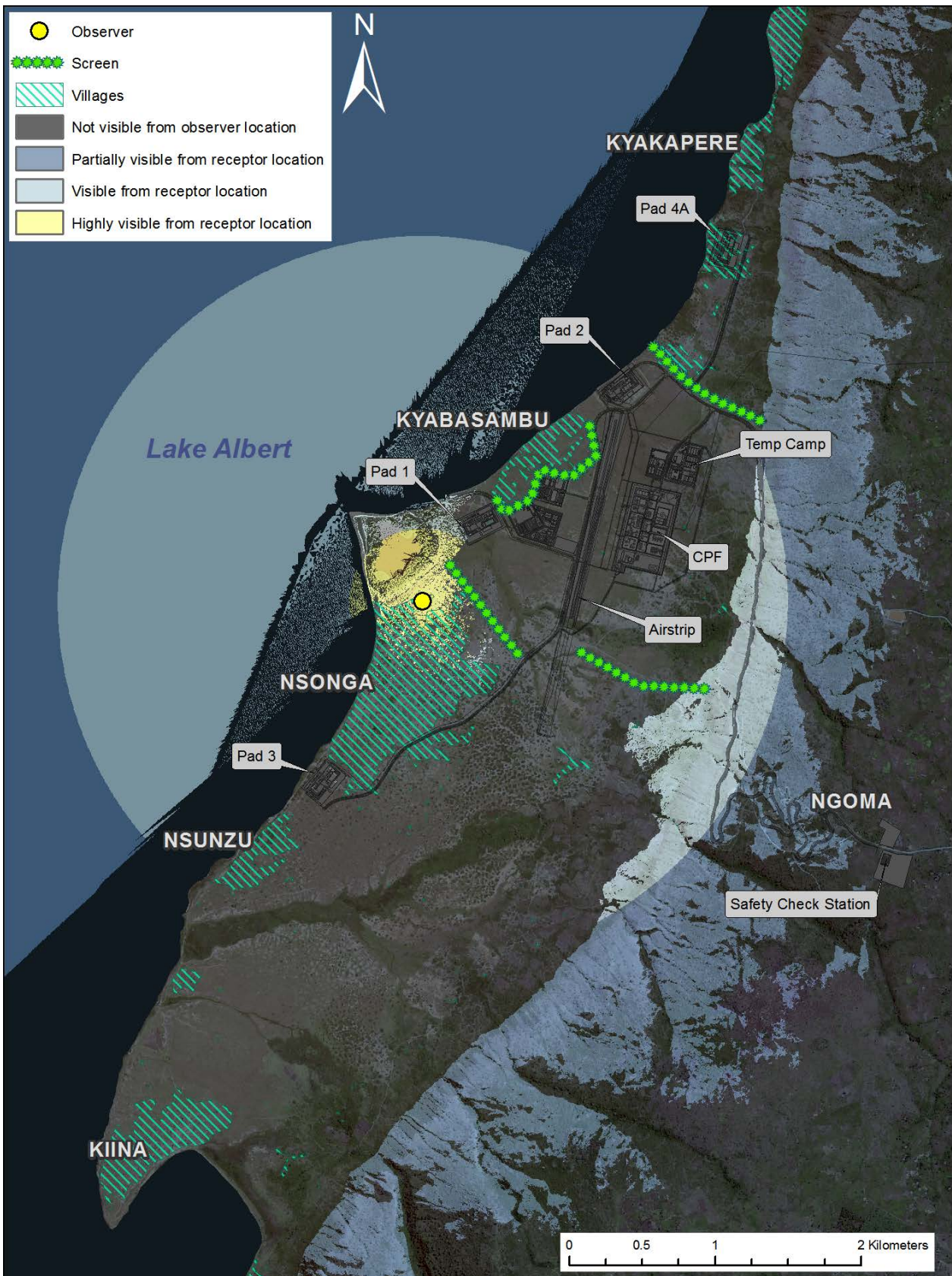

Figure 26: Visibility of project infrastructure from Nsonga village north (receptor-based viewshed) after screening

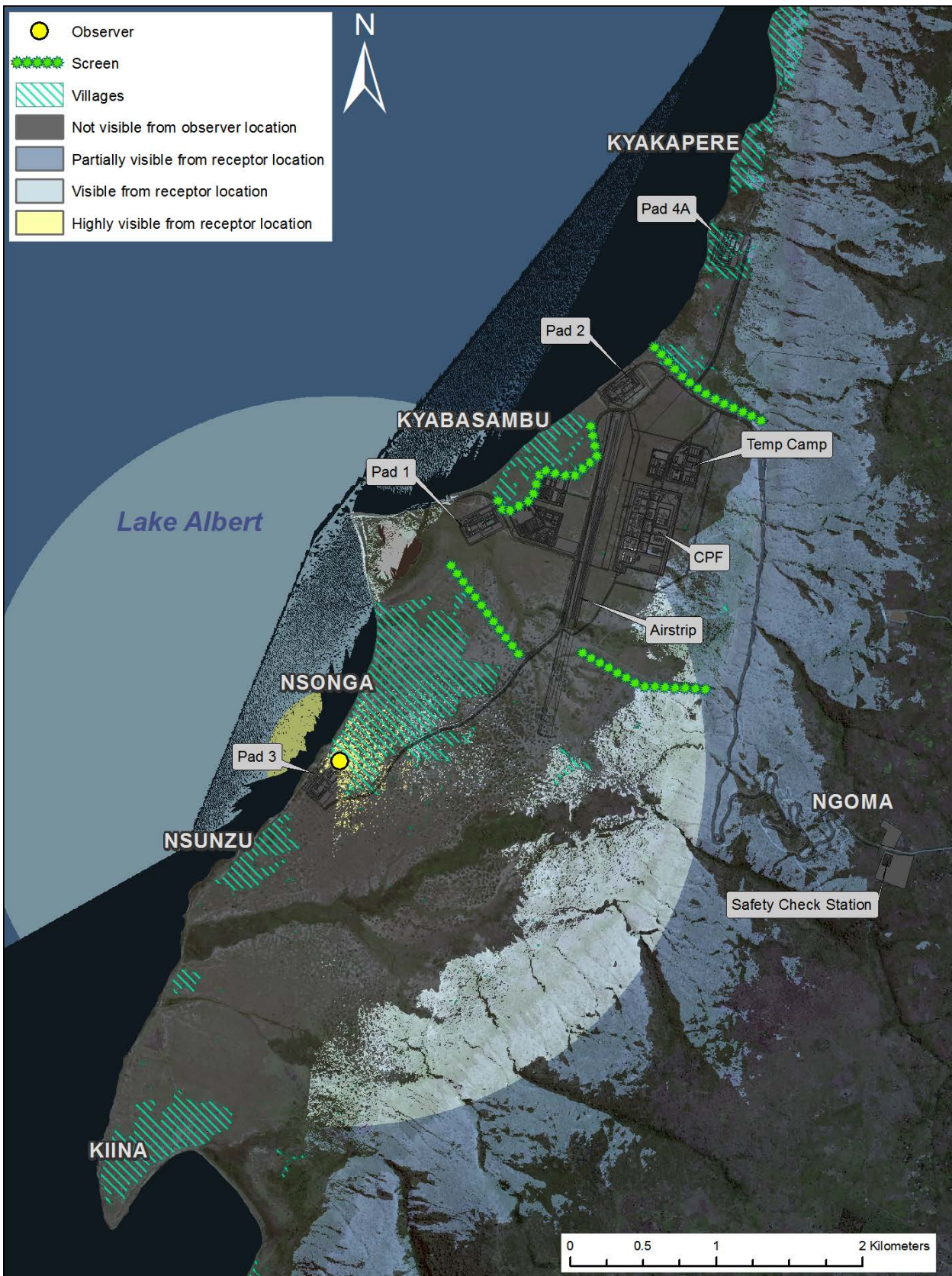

Figure 27: Visibility of project infrastructure from Nsonga village south (receptor-based viewshed) after screening





VISUAL IMPACT ASSESSMENT REPORT



Figure 28: Daytime view of the CPF site from the northwest, before (top) and after (bottom) visual mitigation



5.3.6.3 *Night-time light pollution*

Full cut-off shielding in light fixtures is the essential remedy for both glare and sky glow. A lamp should send all of its light more or less downwards where the light is intended to be used, and not upward or sideways. "Full cut off" is usually taken to mean that no direct light rays from the fixture shine above the horizon, and that at least 90 percent of the light is blocked in the near-sideways range, from 0° to 20° below the horizontal plane. Light that shines in this near-sideways range creates a dazzling annoyance to nearby receptors and contributes nothing to most lighting needs, as it merely dissipates uselessly into the distance.

To minimise both direct glare and indirect sky glow or haze, the following measures are recommended:

- Identify zones of high and low lighting requirements, focusing on only illuminating areas to the minimum extent possible to allow safe operations at night and for security surveillance;
- Plan the lighting requirements of the facilities to ensure that lighting meets the need to keep the site secure and safe, without resulting in excessive illumination;
- Reduce the heights of light post where possible and develop a lighting plan that focusses on illuminating the required areas through strategically placed individual lights rather than mass light flooding;
- Utilise security lights that are movement activated rather than permanently switched on where feasible, to prevent unnecessary constant illumination;
- Fit all security lighting with 'blinkers' or specifically designed fixtures, to ensure light is directed downwards while preventing side spill. Light fixtures of this description are commonly available for a variety of uses and should be used to the greatest extent possible; and
- Eliminate any ground-level spotlights as these invariably result in both direct glare and increased sky glow, and cannot be effectively mitigated.

In addition to the above measures, the proposed vegetation screens should be as dense as possible and maintained to ensure that no breaks in the tree-line are formed, as this will compromise their effectiveness (Figure 29 to Figure 32). Multiple rows of trees that are rotationally coppiced and pruned will likely be required to ensure that sufficient foliage density is achieved (Figure 33 and Figure 34).

It is important that the local villagers be consulted beforehand in this regard, to ensure that the trees are not cut down for firewood. Critically, the project design team should ensure that the proposed tree screens do not compromise any sites of cultural or spiritual significance, as this is sure to result in them being cut down.

5.3.6.4 *Loss of sense of place*

As previously mentioned, the likely loss of sense of place during the operational phase will be significant, as the visual impact of the project infrastructure during the day and light pollution at night respectively can only be partially mitigated. While the proposed vegetation screens may block the infrastructure to some extent, the drill rig will still be visible from most locations due to its height. Furthermore, the infrastructure cannot be effectively screened from views along the escarpment or from large portions of the adjacent lake surface.

For this reason, it is imperative that the project site be effectively and completely rehabilitated once the operational lifespan of the project has ended, to ensure that no residual visual impacts remain. To this end, the original site topography should be recreated as closely as possible and the original vegetation cover reinstated. All traces of the vegetation screens should also be removed, to ensure that the exotic Eucalyptus trees do not become naturalised and spread after closure. This action would also include soil amelioration as required, to ensure that the natural vegetation can be successfully re-established.

Additionally, all buildings, production and infrastructure including associated footprint disturbances should be removed and rehabilitated, and any potential soil contamination should be effectively remediated. It is furthermore recommended that an attempt be made to operationally rehabilitate the spoil rock piles below the access road where possible, to reduce the level of long-term impact associated with this feature.

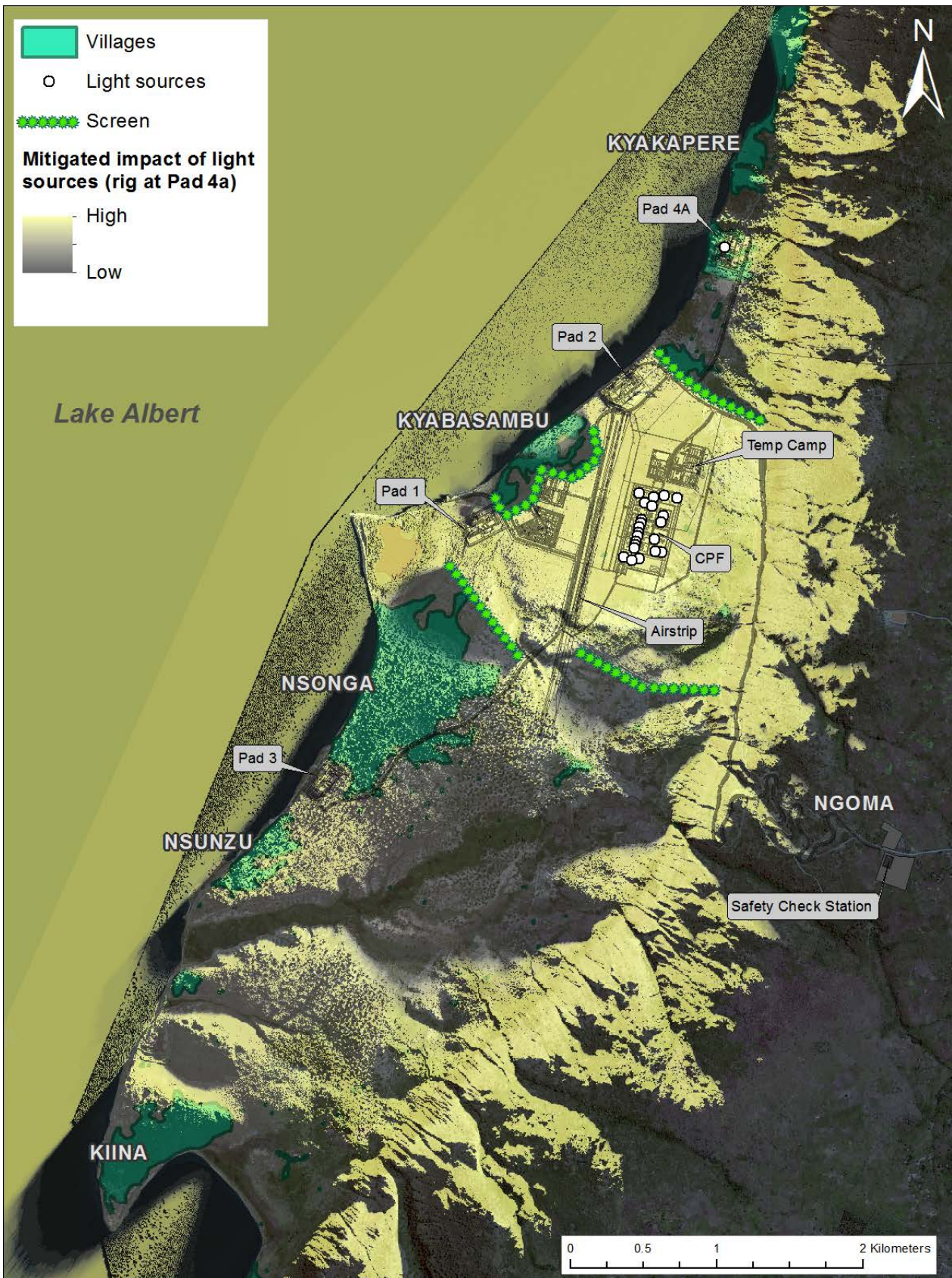

Figure 29: Night-time illumination (impactor-based viewshed) within study area for CPF and drill rig at well pad 4, after screening



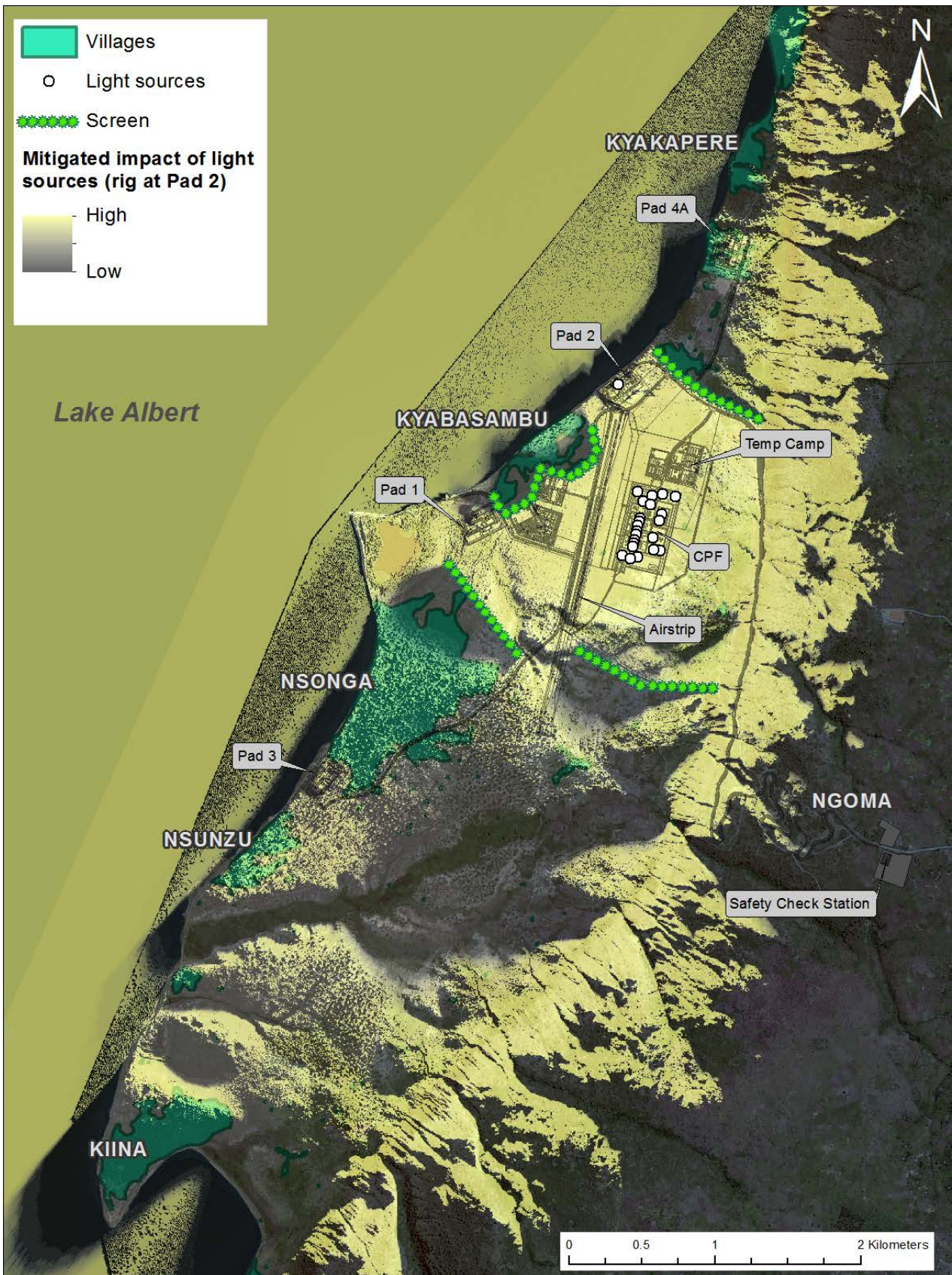

Figure 30: Night-time illumination (impactor-based viewshed) within study area for CPF and drill rig at well pad 2, after screening



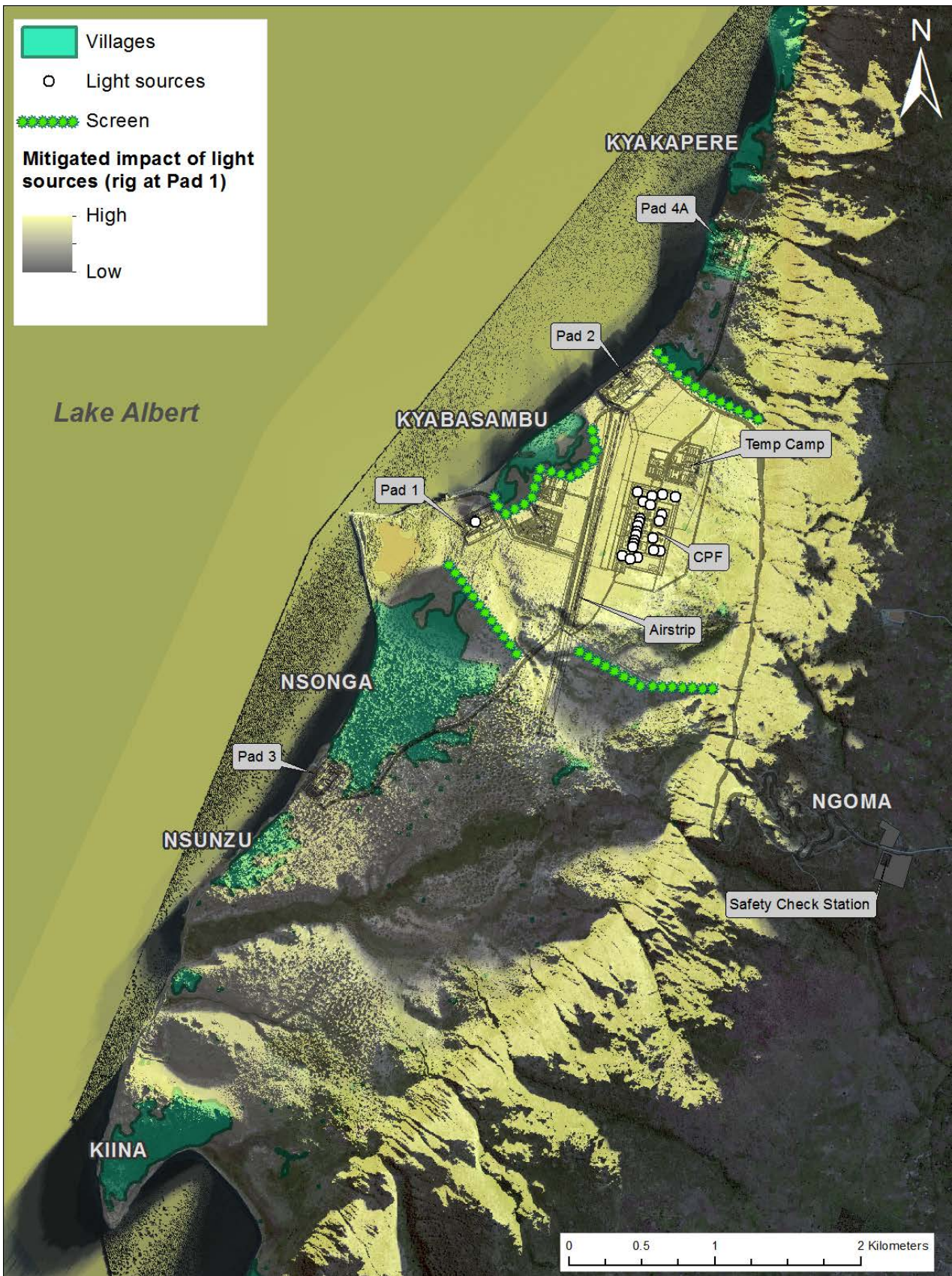

Figure 31: Night-time illumination (impactor-based viewshed) within study area for CPF and drill rig at well pad 1, after screening



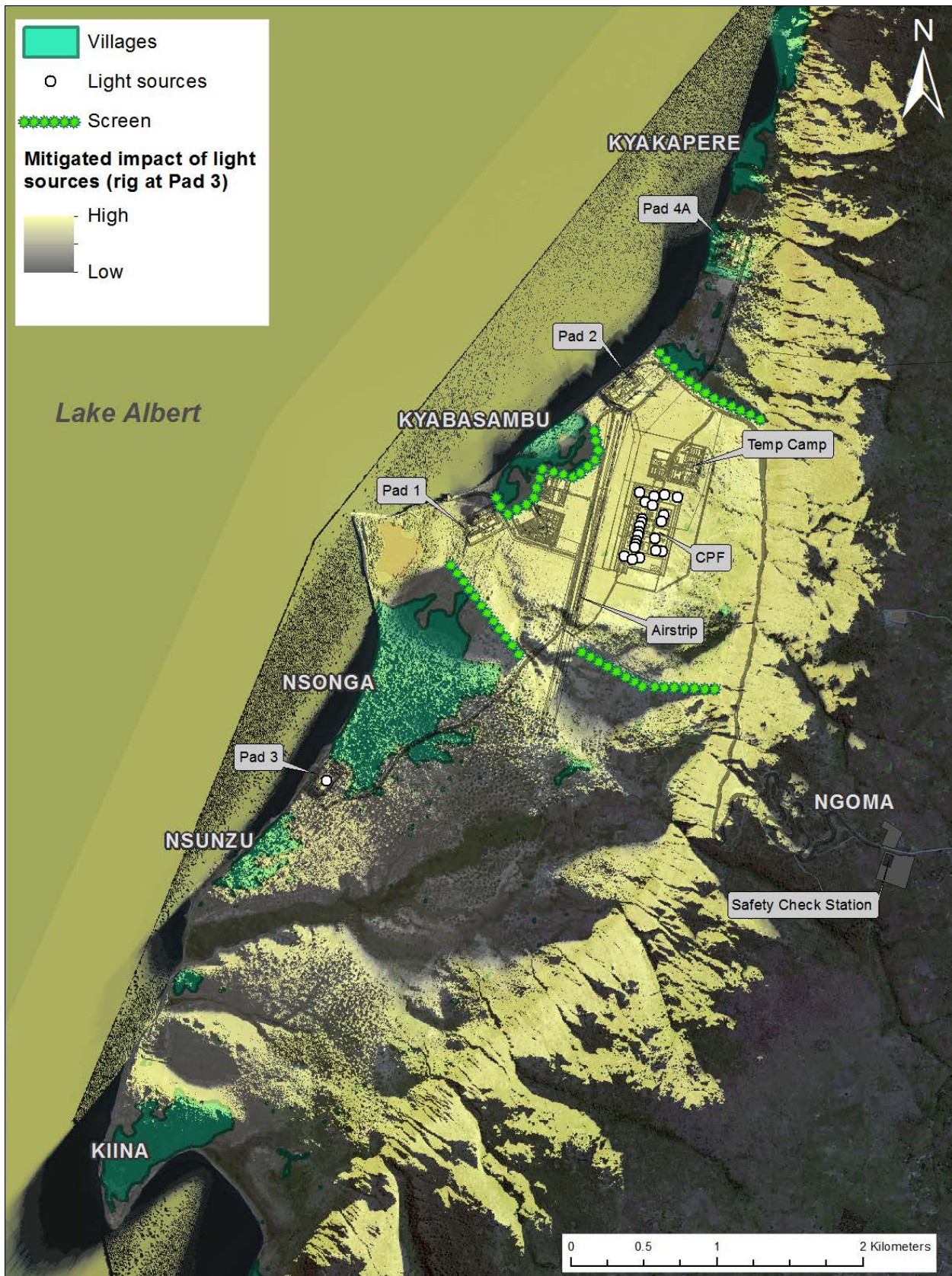

Figure 32: Night-time illumination (impactor-based viewshed) within study area for CPF and drill rig at well pad 3, after screening



Figure 33: Night-time view of the permanent camp, CPF site and drill rig at well pads 1, before (top) and after (bottom) implementation of screening



Figure 34: Night-time view of the CPF site from the northwest, before (top) and after (bottom) implementation of screening



Table 12: Summary of pre- and post-mitigation impact significance

Impact	Pre-mitigation			Post-mitigation		
	Receptor sensitivity	Magnitude	Significance	Receptor sensitivity	Magnitude	Significance
Alteration of site character including topography and loss of vegetation cover during operations	High	Moderate	Major	High	Low	Moderate
Visually intrusive infrastructure (day-time impact) during operations	High	Low	Moderate	High	Low	Moderate
Light pollution (night-time impact) during operations	High	Moderate	Major	High	Low	Moderate
Long-term resultant loss of sense of place as secondary impact	High	Moderate	Major	High	Negligible	Minor





6.0 PIPELINE CORRIDOR

6.1 Study area

As discussed in Section 3.0 and illustrated by Figure 2, the CNOOC Kingfisher oil Field project entails two main components. Section 2 of this VIA dealt with the main production facility located adjacent to Lake Albert, whereas Section 3 assesses the visual impact of the distribution pipeline that will connect the production facility with a new refining facility to be constructed at Kabaale, 52 km to the east.

The pipeline will be completely buried, and as such the majority of visual impacts are therefore expected to occur during the construction phase of the project. The proposed pipeline alignment also traverses a visual environment that is already significantly altered, mainly passing through agricultural farmland and timber plantations, as well as numerous villages and larger urban areas. In most instances the visual impacts caused during the construction process are therefore unlikely to be visible over medium or long-range distances, due to the screening effect of existing vegetation, local topographical landforms and development. The only exceptions will be in instances where the pipeline traverses fields or expansive clearings, or where there are elevated viewpoints surrounding the pipeline corridor, and longer range views are therefore possible. For the purposes of the VIA, the pipeline study area therefore only comprises the pipeline corridor and its immediate surroundings, to an average range of no more than 500 m.

6.2 Baseline visual resource value assessment

6.2.1 Landscape visual character

The topography along the supply pipeline route from the Buhuka Flats and the refinery at Kabaale varies greatly, however the majority of the inland area east of Lake Albert and the escarpment is characterised by rolling hills. The larger watercourses are usually associated with wide valleys and more hilly terrain, whereas large parts of the interior are relatively featureless and somewhat flat. The visual resource value of the topography therefore varies throughout the pipeline study area, but on the whole is considered to be **low (1)**.

While a number of fairly large rivers and lesser watercourses are encountered along the pipeline corridor, these elements are often partially or completely screened by vegetation or development in longer-range views. In the majority of instances the banks of the watercourses have also been partially transformed by human activity or erosion, and are sometimes littered with rubbish and debris. Appealing views of waterbodies are encountered in a number of instances, but they are only significant on a local scale. For this reason the visual resource value of the water features along the pipeline corridor is rated as **low (1)**.

Large parts of the countryside have historically been cleared and are characterised by a mosaic of croplands, timber plantations, low density rural settlements, secondary vegetation regrowth and isolated clumps of remaining forest vegetation. Stretches of land now characterised by grassland or savannah-like conditions may once also have been covered by forests, and are also frequently encountered along the pipeline corridor. As a result the vegetation cover encountered along the pipeline corridor also varies greatly, but in most instances still retains a degree of visual appeal and the visual resource value is therefore rated as **moderate (2)**.

As can be expected from the above descriptions, the visual absorption capacity of the study area varies greatly along the pipeline corridor, depending on the prevalent land cover and uses. In instances where large open fields are encountered the visual absorption capacity of the existing landscape is quite low, whereas that of the built-up urban and village areas is significantly higher. However the absorption capacity of the majority of the study area varies somewhat between these extremes, and as a whole is therefore rated as being **moderate (2)**.

Small villages and settlements that dot the greater region are the frequently encountered along the pipeline corridor, and many retain a certain rural character especially where more traditional construction methods are used. The larger towns are typical of a developing African nation, and are characterised by a degree of disarray and a somewhat haphazard overall structure and lower visual appeal than the more rural settlements. The substantial length of the pipeline corridor study area and the varying visual character encountered makes it impossible to describe its sense of place as a whole. However with the possibility of a



few localised exceptions, the visual character of the pipeline study area is typical of the greater region and therefore rated as possessing a **low (1)** sense of place.

6.2.2 Visual resource value assessment

The visual resource value ratings assigned to each of the visual attributes determined in Section 6.2.1 are summarised in Table 13 below.

Table 13: Pipeline corridor study area visual resource summary

Visual baseline attribute	Topography	Water bodies	Vegetation	VAC	Sense of place
Visual resource value score	low (1)	low (1)	moderate (2)	moderate (2)	low (1)
Total visual resource value score					7*

(*Where: 13 – 15 = High; 9 – 12 = Moderate; 5 – 8 = Low)

From the assessment performed in Section 6.2.1 and the score ranges presented in Table 13, it is concluded that the visual resource value of the pipeline study area as a whole is **low**. However, it must be borne in mind that localised areas with moderate or even high visual resource are still be encountered, especially where the landscape is still mostly untransformed and appealing features such as rivers and indigenous vegetation are encountered.

An assessment of the expected visual impacts that would arise as a consequence of the construction of the pipeline was subsequently conducted as described in Section 6.3.

6.3 Visual impact assessment

Figure 35 below illustrates a number of representative pipeline construction sites in countryside settings and along an existing road, indicating typical visual impacts associated with projects of this nature. The level of visibility, visual intrusion and proximity of the production facility to identified receptors was evaluated in Sections 6.3.3.1 to 6.3.3.2 respectively. No viewshed analyses were performed for the pipeline, due to the relatively short construction period and generally limited visual range of the study area around the pipeline corridor. Accordingly the visibility and visual exposure to the project was subjectively estimated based on previous experience on similar projects.





6.3.2 Project phases and potential visual impacts



Positioning and lowering of a pipeline along an existing servitude/clearing through a wooded area



Final placement of a pipeline along a newly created corridor through a wooded area



Positioning of a pipeline within a servitude using an existing road as access way



Temporary pipeline and material laydown area

Figure 35: Typical construction related activities and visual impacts associated with the construction phase of a large pipeline project (images Wikipedia, 2017; CCPipeline, 2017)

6.3.3 Visual impact criteria

6.3.3.1 Visibility

The pipeline construction activities will continuously move along the corridor as one section is opened up, the pipe sections placed and the excavations subsequently closed. The degree to which these activities will be visible at any given point in time will therefore vary considerably, as a function of the local topography and land cover. Large sections of the pipeline will be constructed adjacent to existing roads or within servitudes for other linear services, which will increase the visibility of these construction sites somewhat. However, given that these views will in most instances still be reduced to within short (500 m) or at most medium range (i.e. around 2.5 km) the overall visibility of the project construction activities is rated as **low (1)**.

6.3.3.2 Visual exposure

The degree of visual exposure of receptors to the pipeline construction activities in a given area will also vary, depending on the proximity of that section of pipeline to human activity. However, large sections of the pipeline will be located adjacent to roads and will also pass close by numerous villages, and in these instances the visual receptors will be situated close to the construction site and activities. The level of visual exposure at any given area of construction is therefore rated as **high (3)**.

6.3.3.3 Visual intrusion

Regardless of its limited extent, the construction site involves a number of visually intrusive elements including an open pipe trench and soil stockpiles, bare access way and laydown areas, stockpiled sections





of pipe, various construction machinery and safety barricades. The locality of the construction site is also characterised by intense activity as machinery, construction materials and people are constantly in motion. Furthermore, the construction site can be a source of nuisance when located where people live or commute, as the site is usually dusty, noisy and results in traffic disruption. For this reason the level of visual intrusion of the site during the construction phase is rated as being **moderate (2)**. Once construction has been completed the degree of visual intrusion will progressively decrease, as rehabilitation measures are implemented and re-vegetation progresses.

In summary, the visual impact criteria ratings for the construction and operational phases of the project performed in Section 6.3.3 above are indicated in Table 14.

Table 14: Visual impact criteria rating

Visual impact	Visual impact criteria			Total rating score
	Visibility	Visual exposure	Visual intrusion	
Visual impact associated with construction phase	Low (1)	High (3)	Moderate (2)	6 (Moderate)
Visual impact associated with operational phase	Low (1)	High (3)	Low (1)	5 (Low)

(* Where for the total rating score: 3-5 = low; 6-7 = moderate; and 8-9 = high)

6.3.4 Impact intensity

The intensity of each visual impact was then determined as a function of the visual resource value of the receiving landscape study area (Table 13), together with the visual impact criteria, as summarised in Table 14.

Table 15: Visual impact intensity

Visual resource value	Visual impact criteria rating		
	High	Moderate	Low
High	High (4)	High (4)	Moderate (3)
Moderate	High (4)	Moderate (3)	Low (2)
Low	Moderate (3)	Low (2)	Very low (1)

Accordingly, the intensity of the visual impacts associated with the pipeline section of the project is as follows:

- Visual impact associated with construction phase – **Low (2)**; and
- Visual impact associated with operational phase – **Very low (1)**.

6.3.5 Impact magnitude

The magnitude of each of the construction and operational impacts were determined using the impact intensity determine in Section 6.3.4 above and the criteria listed in Section 5.3.4 indicated in Table 16 below.





Table 16: Visual impact magnitude

Visual impact (Adverse)	Impact magnitude determination criteria				Total magnitude score*
	Intensity	Extent	Duration	Reversibility	
Visual impact associated with construction phase	Low (2)	Local (1)	Short-term (1)	Largely (2)	6
Visual impact associated with operational phase	Very low (1)	Local (1)	Medium-term (2)	Largely (2)	6

(*Where for the total magnitude score 4-6 = Negligible; 7-9 = Low; 10-12 = Moderate; 13-15 = High)

Accordingly, the magnitude of each impact is as follows:

- Visual impact associated with construction phase – **Negligible**; and
- Visual impact associated with operational phase – **Negligible**.

6.3.6 Impact significance

6.3.6.1 Visual receptor sensitivity

Visual receptors of the pipeline construction process will be a mixture of transient and resident receptors, and will be largely dependent on where construction is taking place at a specific point in time. In a general sense, resident receptors are expected to attach a higher value to the character and appearance of the visual landscape than transient receptors would, as the former live in and are therefore exposed to any landscape changes for as long as they last. However adopting a conservative approach the perceived landscape value of the majority of potential visual receptors to the pipeline project is expected to at least be **moderate**. Furthermore, the number of potential receptors to a given section of pipeline construction will also vary greatly for obvious reasons, however where the pipeline is located near village or towns or along frequently travelled sections of road, the number of receptors could be significant. For this reason the receptor incidence was rated as **high**.

Table 17: Visual receptor sensitivity

Receptor perceived landscape value	Number of receptors that will see the project (incidence factor)		
	Large	Moderate	Small
High	High	High	Moderate
Moderate	High	Moderate	Low
Low	Moderate	Low	Very low

Based on the anticipated varying levels of perceived landscape value towards the study area and the fact that large numbers of people will likely to be exposed to sections of the project, the overall receptor sensitivity for the pipeline was determined to be **high**.

6.3.6.2 Impact significance assessment

The significance of each visual impact was determined as a function of the magnitude (Table 16) of the impact, together with the visual receptor sensitivity (Table 17); as summarised in Table 18:





Table 18: Determination of impact significance

Magnitude of Impact	Sensitivity of receptor			
	Very low	Low	Medium	High
Negligible	1 Negligible	2 Minor	3 Minor	4 Minor
Low	2 Minor	4 Minor	6 Moderate	8 Moderate
Moderate	3 Minor	6 Moderate	9 Moderate	12 Major
High	4 Minor	8 Moderate	12 Major	16 Major

Accordingly, the significance of each impact is as follows:

- Visual impact associated with construction phase – **Minor**; and
- Visual impact associated with operational phase – **Minor**.

6.3.7 Visual impact mitigation

Opportunities for visual mitigation during the construction phase is limited due to practical constraints and safety considerations, as well as the relatively short time period that construction will take place in any given area. Nevertheless, a high standard of general housekeeping and management of the construction site should be maintained to ensure that further impacts are avoided.

The bulk of visual mitigation must focus on reversing the visually intrusive and unsightly effects of the construction process, by rehabilitating the closed-up sections of the pipeline trench and access roads as quickly as possible. Specific rehabilitation activities will be highly site-specific, however Figure 36 illustrates a typical sequence of rehabilitation activities in this regard.





Initial backfilled pipeline corridor along a steep embankment protected against erosion with mulch and sediment netting (left) and subsequently soil binding polymers (right)



Corridor re-vegetated with grasses and stabilised with erosion-prevention structures, which will in time be re-colonised with suitable tree species (images Beneterra, 2017)

Figure 36: Rehabilitation of a backfilled pipeline corridor

Table 19: Summary of pre- and post-mitigation impact significance

Impact	Pre-mitigation			Post-mitigation		
	Receptor sensitivity	Magnitude	Significance	Receptor sensitivity	Magnitude	Significance
Visual impact associated with construction phase	High	Negligible	Minor	High	Negligible	Minor
Visual impact associated with operational phase	High	Moderate (if adequate rehabilitation is not implemented)	Major	High	Negligible	Minor





7.0 CONCLUSION

The CNOOC Kingfisher Oil Field involves two main components, mainly the construction of a new production facility on the Buhuka flats on the south-eastern shore of Lake Albert; and a crude oil pipeline from the facility will be transferred to delivery point about 52 km northeast of the Kingfisher project. The project is expected to result in a number of visual impacts, which will vary in significance for the two main project components.

The visual resource value of the production facility study area as a whole is considered to be high, based on the appeal of its physical characteristics, as well as the innate and strongly defined sense of place of the study area. The development of the production facility will introduce various visually contrasting infrastructure components into the landscape, which will negatively impact on the visual resource value of the study area. Furthermore the infrastructure will be brightly lit at night which will result in significant visual intrusion, due to the close proximity of local villages to the infrastructure site.

A high overall receptor sensitivity was determined for the project study area, based on the very high perceived landscape value and number of local villagers that will be permanently exposed to the production facility for its operational lifespan. Accordingly, the majority of operational visual impacts for the production facility have been rated as having a high social significance, and it is imperative to ensure that appropriate visual mitigation is implemented.

The majority of operational mitigation centres on screening the main infrastructure elements from critical viewpoints by implementing vegetation screens, as well as reducing the amount of wasteful or disturbing lighting at night. However the extent to which operational impacts can be mitigated is expected to be limited. The balance of the visual mitigation efforts must therefore focus on ensuring that the project does not result in any lasting or long-term impacts once the site has been decommissioned and rehabilitated, as this would greatly reduce the uniqueness of the site's sense of place.

In contrast, the visual resource value of the pipeline study area is generally low, although localised areas with moderate or even high visual resources are still encountered in certain locations. Based on the anticipated varying levels of perceived landscape value towards the study area and the fact that large numbers of people will likely to be exposed to sections of the project, the overall receptor sensitivity for the pipeline is expected to still be high.

The majority of the visual impact associated with the pipeline will occur during the construction phase, and will be relatively localised and of short duration. The resultant significance of these impacts are therefore deemed to be of relatively minor social significance. The bulk of the visual mitigation will focus on reversing the visually intrusive and unsightly effects of the construction process, by rehabilitating the closed-up sections of the pipeline trench and access roads as quickly as possible.

8.0 RECOMMENDATIONS AND WAY FORWARD

It is recommended that the following be conducted going forward, to ensure that appropriate and successful visual mitigation measures are identified and implemented:

- On-site verification should be conducted to identify optimal locations for proposed vegetation screens at the production facility site, based on the results of the viewshed analyses. The extent and orientation of the individual tree screens should be determined on site by conducting line-of-sight evaluations from the respective villages to the individual project infrastructure sites; aware of
- Trials must be conducted to identify the most suitable tree and shrub species to be utilised for establishing the vegetation screens. The selection of plant species must be cognisant of local soil conditions and rainfall, maintenance requirements, expected lifespan and foliage density, as well as the potential for the plants to become invasive;
- A lighting plan and lighting specifications must be developed for the production facility beforehand, with the aim of focussing illumination on critical areas only and minimising sideways and upwards light pollution;





- The impact of night-time illumination of the infrastructure on other biota is acknowledged but has not been assessed as part of this VIA, and will need to be determined using precedent studies and possibly on-site trials; and
- The local villagers must be consulted as part of the visual mitigation planning process, to ensure that proposed measures do not compromise any sites of cultural or spiritual significance.



9.0 REFERENCES

Low, S M (1992). Symbolic Ties that Bind: Place Attachment in the Plaza, in *Place Attachment*, Pp. 165-186. edited by Irwin Altman and Setha Low. New York: Plenum Press.

Beneterra (2017). [Online] Available: <https://www.beneterra.com/beneterra-completes-difficult-pipeline-corridor-rehab/>

CCPipeline (2017). [Online] Available: <http://ccpipeline.weebly.com/about.html>

Crawford D (1994). Using remotely sensed data in landscape visual quality assessment, in *Landscape and Urban Planning*, No 30 p 71-81.

Golder (2014). Final Scoping Report for the Environmental & Social Impact Assessment for Kingfisher Discovery Area in Hoima District, Uganda by CNOOC Uganda Ltd (Report Number 13615730-12471-3) Report Number:

Golder (2014). Socio-economic Impact Assessment for the proposed Kingfisher Development (Report Number 13615730-12964-15)

Golder (2017). Cultural Heritage Report - Environmental and Social Impact Assessment for Kingfisher Development Area, Hoima District, Uganda (Report Number 13615730-1351450632-501)

Google Earth aerial imagery from January 2012 and January 2013 respectively

Lynch, K. 1992. Good City Form. The MIT Press. p 131.

NLA. (2004). *Visual Impact Assessment for Proposed Long-term Coal Supply to Eskom's Majuba*. Johannesburg.

Oberholzer B (2005). *Guideline for Involving Visual and Aesthetic Specialists in EIA Processes. Edition 1* (Draft for Comment). [Online] Available: http://www.capegateway.gov.za/Text/2005/4/deadp_visual_guideline_draft_15april05.pdf (accessed 02 September 2005).

Photographs of the project site taken by the visual assessment specialist from 3 to 4 December 2014

Wikipedia (2017). NEL Pipeline. [Online] Available: https://en.wikipedia.org/wiki/NEL_pipeline



GOLDER ASSOCIATES AFRICA (PTY) LTD.

Author: Johan Bothma
Visual Assessment Specialist
M.LArch. Landscape Architecture, BLArch.

Senior Review: Brent Baxter
Senior EIA Consultant
PhD University of Natal, BSc Hons, BSc.,
Professional Natural Scientist (Botanical, Environmental
Sciences), Registered Environmental Assessment Professional